















QF adapters and accessories

Adapters and various accessories for QF ducting systems

















Product name	QF adapters and accessories
Include in Tech Data Sheet	True
End Type A	QF
Length (unit)	m

QF adapters and accessories

Image	Short description	Suitable markets (Nordfab)	Legacy Item No.	Length (for import)	Material	Material Thickness	Diameter A	Diameter B	End Type B	Inner dimension (ID)	Outer dimension (OD)	Rolled Edge (mm)	Length	Weight	Model
	Adapter Flange Galv 0,7mm 80QF 80FLN	Europe (non UK)	22007-080		Galv	0,7mm	80	80	FLN					0,25	821000000
	Adapter Flange Galv 0,7mm 100QF 100FLN	Europe (non UK)	22007-100		Galv	0,7mm	100	100	FLN					0,42	821000001
	Adapter Flange Galv 0,7mm 125QF 125FLN	Europe (non UK)	22007-125		Galv	0,7mm	125	125	FLN					0,62	821000002
	Adapter Flange Galv 0,7mm 140QF 140FLN	Europe (non UK)	22007-140		Galv	0,7mm	140	140	FLN					0,69	821000003
	Adapter Flange Galv 0,7mm 150QF 150FLN	Europe (non UK)	22007-150		Galv	0,7mm	150	150	FLN					0,68	821000004
	Adapter Flange Galv 0,7mm 160QF 160FLN	Europe (non UK)	22007-160		Galv	0,7mm	160	160	FLN					0,77	821000005
	Adapter Flange Galv 0,7mm 180QF 180FLN	Europe (non UK)	22007-180		Galv	0,7mm	180	180	FLN					0,87	821000006
	Adapter Flange Galv 0,7mm 200QF 200FLN	Europe (non UK)	22007-200		Galv	0,7mm	200	200	FLN					0,96	821000007
	Adapter Flange Galv 0,7mm 224QF 224FLN	Europe (non UK)	22007-224		Galv	0,7mm	224	224	FLN					1,17	821000008
	Adapter Flange Galv 0,7mm 250QF 250FLN	Europe (non UK)	22007-250		Galv	0,7mm	250	250	FLN					1,38	821000009
	Adapter Flange Galv 0,7mm 300QF 300FLN	Europe (non UK)	22007-300		Galv	0,7mm	300	300	FLN					1,63	821000010
	Adapter Flange Galv 0,7mm 315QF 315FLN	Europe (non UK)	22007-315		Galv	0,7mm	315	315	FLN					1,71	821000011
	Adapter Flange Galv 0,7mm 350QF 350FLN	Europe (non UK)	22007-350		Galv	0,7mm	350	350	FLN					1,89	821000012
	Adapter Flange Galv 0,9mm 400QF 400FLN	Europe (non UK)	22007-400		Galv	0,9mm	400	400	FLN					2,13	821000013
	Adapter Flange Galv 0,9mm 450QF 450FLN	Europe (non UK)	22007-450		Galv	0,9mm	450	450	FLN					2,38	821000014

QF adapters and accessories

Image	Short description	Suitable markets (Nordfab)	Legacy Item No.	Length (for import)	Material	Material Thickness	Diameter A	Diameter B	End Type B	Inner dimension (ID)	Outer dimension (OD)	Rolled Edge (mm)	Length	Weight	Model
	Adapter Flange Galv 0,9mm 500QF 500FLN	Europe (non UK)	22007-500		Galv	0,9mm	500	500	FLN					2,65	821000015
	Adapter Flange Galv 0,9mm 560QF 560FLN	Europe (non UK)	22007-560		Galv	0,9mm	560	560	FLN					2,95	821000016
	Adapter Flange Galv 0,9mm 630QF 630FLN	Europe (non UK)	22007-630		Galv	0,9mm	630	630	FLN					3,28	821000017
	Adapter Flange Galv 0,9mm 710QF 710FLN	Europe (non UK)	22007-710		Galv	0,9mm	710	710	FLN					3,69	821000018
	Adapter Rivet Galv 0,7mm 100QF	Europe (non UK)	22008-100		Galv	0,7mm	100							0,12	821000050
	Adapter Rivet Galv 0,7mm 125QF	Europe (non UK)	22008-125		Galv	0,7mm	125							0,15	821000051
	Adapter Rivet Galv 0,7mm 140QF	Europe (non UK)	22008-140		Galv	0,7mm	140							0,17	821000052
	Adapter Rivet Galv 0,7mm 150QF	Europe (non UK)	22008-150		Galv	0,7mm	150							0,18	821000053
	Adapter Rivet Galv 0,7mm 160QF	Europe (non UK)	22008-160		Galv	0,7mm	160							0,19	821000054
	Adapter Rivet Galv 0,7mm 180QF	Europe (non UK)	22008-180		Galv	0,7mm	180							0,23	821000055
	Adapter Rivet Galv 0,7mm 200QF	Europe (non UK)	22008-200		Galv	0,7mm	200							0,25	821000056
	Adapter Rivet Galv 0,7mm 224QF	Europe (non UK)	22008-224		Galv	0,7mm	224							0,28	821000057
	Adapter Rivet Galv 0,7mm 250QF	Europe (non UK)	22008-250		Galv	0,7mm	250							0,32	821000058
	Adapter Rivet Galv 0,7mm 300QF	Europe (non UK)	22008-300		Galv	0,7mm	300							0,39	821000059
	Adapter Rivet Galv 0,7mm 315QF	Europe (non UK)	22008-315		Galv	0,7mm	315							0,41	821000060

QF adapters and accessories

Image	Short description	Suitable markets (Nordfab)	Legacy Item No.	Length (for import)	Material	Material Thickness	Diameter A	Diameter B	End Type B	Inner dimension (ID)	Outer dimension (OD)	Rolled Edge (mm)	Length	Weight	Model
	Adapter Rivet Galv 0,9mm 400QF	Europe (non UK)	22008-400		Galv	0,9mm	400							0,68	821000062
	Adapter Rivet Galv 0,7mm 350QF	Europe (non UK)	22008-350		Galv	0,7mm	350							0,46	821000061
	Adapter Rivet Galv 0,9mm 450QF	Europe (non UK)	22008-450		Galv	0,9mm	450							0,76	821000063
	Adapter Rivet Galv 0,9mm 500QF	Europe (non UK)	22008-500		Galv	0,9mm	500							0,84	821000064
	Adapter Rivet Galv 0,9mm 560QF	Europe (non UK)	22008-560		Galv	0,9mm	560							0,95	821000065
	Adapter Rivet Galv 0,9mm 630QF	Europe (non UK)	22008-630		Galv	0,9mm	630							1,06	821000066
	Adapter Rivet Galv 0,9mm 710QF	Europe (non UK)	22008-710		Galv	0,9mm	710							1,20	821000067
	End Cap Galv 0,7mm 80QF	Europe (non UK)	22012-080		Galv	0,7mm	80						50	0,16	821000102
	End Cap Galv 0,7mm 100QF	Europe (non UK)	22012-100		Galv	0,7mm	100			97	98	6	50	0,26	821000103
	End Cap Galv 0,7mm 125QF	Europe (non UK)	22012-125		Galv	0,7mm	125			123	124	6	50	0,40	821000104
	End Cap Galv 0,7mm 140QF	Europe (non UK)	22012-140		Galv	0,7mm	140			138	139	6	50	0,46	821000105
	End Cap Galv 0,7mm 150QF	Europe (non UK)	22012-150		Galv	0,7mm	150			147	148	6	50	0,30	821000106
	End Cap Galv 0,7mm 160QF	Europe (non UK)	22012-160		Galv	0,7mm	160			158	159	6	50	0,34	821000107
	End Cap Galv 0,7mm 180QF	Europe (non UK)	22012-180		Galv	0,7mm	180			178	179	8	50	0,42	821000108
	End Cap Galv 0,7mm 200QF	Europe (non UK)	22012-200		Galv	0,7mm	200			199	200	8	50	0,60	821000109















QF adapters and accessories

Image	Short description	Suitable markets (Nordfab)	Legacy Item No.	Length (for import)	Material	Material Thickness	Diameter A	Diameter B	End Type B	Inner dimension (ID)	Outer dimension (OD)	Rolled Edge (mm)	Length	Weight	Model
	End Cap Galv 0,7mm 224QF	Europe (non UK)	22012-224		Galv	0,7mm	224			223	224	8	50	0,65	8210001020
	End Cap Galv 0,7mm 250QF	Europe (non UK)	22012-250		Galv	0,7mm	250			249	250	8	50	0,68	8210001021
	End Cap Galv 0,7mm 300QF	Europe (non UK)	22012-300		Galv	0,7mm	300			297	298	10	50	0,90	8210001022
	End Cap Galv 0,7mm 315QF	Europe (non UK)	22012-315		Galv	0,7mm	315			312	313	10	50	0,95	8210001023
	End Cap Galv 0,7mm 350QF	Europe (non UK)	22012-350		Galv	0,7mm	350			347	348	10	50	1,08	8210001024
	End Cap Galv 0,9mm 400QF	Europe (non UK)	22012-400		Galv	0,9mm	400			398	400	10	50	1,36	8210001025
	End Cap Galv 0,9mm 450QF	Europe (non UK)	22012-450		Galv	0,9mm	450			447	449	10	50	1,69	8210001026
	End Cap Galv 0,9mm 500QF	Europe (non UK)	22012-500		Galv	0,9mm	500			497	499	10	50	1,91	8210001027
	End Cap Galv 0,9mm 560QF	Europe (non UK)	22012-560		Galv	0,9mm	560			557	559	10	50	2,20	8210001028
	End Cap Galv 0,9mm 630QF	Europe (non UK)	22012-630		Galv	0,9mm	630			62	629	10	50	2,50	8210001029
	End Cap Galv 0,9mm 710QF	Europe (non UK)	22012-710		Galv	0,9mm	710			707	709	10	50	2,90	8210001030
	Adapter Hose Galv 0,7mm 80QF	Europe (non UK)	22013-080		Galv	0,7mm	80			78	79	6	58	0,1	8210000019
	Adapter Hose Galv 0,7mm 100QF	Europe (non UK)	22013-100		Galv	0,7mm	100			97	98	6	58	0,12	8210000020
	Adapter Hose Galv 0,7mm 125QF	Europe (non UK)	22013-125		Galv	0,7mm	125			123	124	6	58	0,15	8210000021
	Adapter Hose Galv 0,7mm 140QF	Europe (non UK)	22013-140		Galv	0,7mm	140			138	139	6	58	0,17	8210000022













QF adapters and accessories

Image	Short description	Suitable markets (Nordfab)	Legacy Item No.	Length (for import)	Material	Material Thickness	Diameter A	Diameter B	End Type B	Inner dimension (ID)	Outer dimension (OD)	Rolled Edge (mm)	Length	Weight	Model
	Adapter Hose Galv 0,7mm 150QF	Europe (non UK)	22013-150		Galv	0,7mm	150			147	148	6	58	0,18	8210000 023
	Adapter Hose Galv 0,7mm 160QF	Europe (non UK)	22013-160		Galv	0,7mm	160			158	159	6	58	0,19	8210000 024
	Adapter Hose Galv 0,7mm 180QF	Europe (non UK)	22013-180		Galv	0,7mm	180			178	179	8	58	0,23	8210000 025
	Adapter Hose Galv 0,7mm 200QF	Europe (non UK)	22013-200		Galv	0,7mm	200			199	200	8	58	0,25	8210000 026
	Adapter Hose Galv 0,7mm 224QF	Europe (non UK)	22013-224		Galv	0,7mm	224			223	224	8	58	0,28	8210000 027
	Adapter Hose Galv 0,7mm 250QF	Europe (non UK)	22013-250		Galv	0,7mm	250			249	250	8	58	0,32	8210000 028
	Adapter Hose Galv 0,7mm 300QF	Europe (non UK)	22013-300		Galv	0,7mm	300			297	298	10	58	0,39	8210000 029
	Adapter Hose Galv 0,7mm 315QF	Europe (non UK)	22013-315		Galv	0,7mm	315			312	313	10	58	0,41	8210000 030
	Adapter Hose Galv 0,7mm 350QF	Europe (non UK)	22013-350		Galv	0,7mm	350			347	348	10	58	0,46	8210000 031
	Adapter Hose Galv 0,9mm 400QF	Europe (non UK)	22013-400		Galv	0,9mm	400			398	400	10	58	0,68	8210000 032
	Adapter Hose Galv 0,9mm 450QF	Europe (non UK)	22013-450		Galv	0,9mm	450			447	449	10	58	0,76	8210000 033
	Adapter Hose Galv 0,9mm 500QF	Europe (non UK)	22013-500		Galv	0,9mm	500			497	499		58	0,84	8210000 034
	Adapter Hose Galv 0,9mm 560QF	Europe (non UK)	22013-560		Galv	0,9mm	560			557	559		58	0,95	8210000 035
	Adapter Hose Galv 0,9mm 630QF	Europe (non UK)	22013-630		Galv	0,9mm	630			627	629		58	1,06	8210000 036
	Adapter Hose Galv 0,9mm 710QF	Europe (non UK)	22013-710		Galv	0,9mm	710			707	709		58	1,2	8210000 037

QF adapters and accessories

Image	Short description	Suitable markets (Nordfab)	Legacy Item No.	Length (for import)	Material	Material Thickness	Diameter A	Diameter B	End Type B	Inner dimension (ID)	Outer dimension (OD)	Rolled Edge (mm)	Length	Weight	Model
	Adapter Ventilation Galv 0,7mm 80QF	Europe (non UK)	22014-080	58	Galv	0,7mm	80							0,16	8210000106
	Adapter Ventilation Galv 0,7mm 100QF	Europe (non UK)	22014-100	58	Galv	0,7mm	100							0,22	8210000107
	Adapter Ventilation Galv 0,7mm 125QF	Europe (non UK)	22014-125	58	Galv	0,7mm	125							0,26	8210000108
	Adapter Ventilation Galv 0,7mm 140QF	Europe (non UK)	22014-140	58	Galv	0,7mm	140							0,30	8210000109
	Adapter Ventilation Galv 0,7mm 150QF	Europe (non UK)	22014-150	58	Galv	0,7mm	150							0,32	8210000110
	Adapter Ventilation Galv 0,7mm 160QF	Europe (non UK)	22014-160	58	Galv	0,7mm	160							0,34	8210000111
	Adapter Ventilation Galv 0,7mm 180QF	Europe (non UK)	22014-180	58	Galv	0,7mm	180							0,38	8210000112
	Adapter Ventilation Galv 0,7mm 200QF	Europe (non UK)	22014-200	116	Galv	0,7mm	200							0,42	8210000113
	Adapter Ventilation Galv 0,7mm 224QF	Europe (non UK)	22014-224	116	Galv	0,7mm	224							0,48	8210000114
	Adapter Ventilation Galv 0,7mm 250QF	Europe (non UK)	22014-250	116	Galv	0,7mm	250							0,54	8210000115
	Adapter Ventilation Galv 0,7mm 300QF	Europe (non UK)	22014-300	116	Galv	0,7mm	300							0,64	8210000116
	Adapter Ventilation Galv 0,7mm 315QF	Europe (non UK)	22014-315	116	Galv	0,7mm	315							0,66	8210000117
	Adapter Ventilation Galv 0,7mm 350QF	Europe (non UK)	22014-350	116	Galv	0,7mm	350							0,74	8210000118
	Adapter Ventilation Galv 0,9mm 400QF	Europe (non UK)	22014-400	116	Galv	0,9mm	400							1,08	8210000119
	Adapter Ventilation Galv 0,9mm 450QF	Europe (non UK)	22014-450	116	Galv	0,9mm	450							1,22	8210000120

QF adapters and accessories

Image	Short description	Suitable markets (Nordfab)	Legacy Item No.	Length (for import)	Material	Material Thickness	Diameter A	Diameter B	End Type B	Inner dimension (ID)	Outer dimension (OD)	Rolled Edge (mm)	Length	Weight	Model
	Adapter Ventilation Galv 0,9mm 500QF	Europe (non UK)	22014-500	116	Galv	0,9mm	500							1,36	8210000121
	Adapter Ventilation Galv 0,9mm 560QF	Europe (non UK)	22014-560	116	Galv	0,9mm	560							1,52	8210000122
	Adapter Ventilation Galv 0,9mm 630QF	Europe (non UK)	22014-630	116	Galv	0,9mm	630							1,71	8210000123
	Adapter Ventilation Galv 0,9mm 710QF	Europe (non UK)	22014-710	116	Galv	0,9mm	710							1,93	8210000124
	Adapter Machine Expanded Galv 0,7mm 80QF L=130mm	Europe (non UK)	22023-080		Galv	0,7mm	80							0,11	8210001855
	Adapter Machine Expanded Galv 0,7mm 125QF L=130mm	Europe (non UK)	22023-125		Galv	0,7mm	125							0,16	8210001857
	Adapter Machine Expanded Galv 0,7mm 140QF L=130mm	Europe (non UK)	22023-140		Galv	0,7mm	140							0,27	8210001858
	Adapter Machine Expanded Galv 0,7mm 150QF L=130mm	Europe (non UK)	22023-150		Galv	0,7mm	150							0,28	8210001859
	Adapter Machine Expanded Galv 0,7mm 160QF L=130mm	Europe (non UK)	22023-160		Galv	0,7mm	160							0,30	8210001860
	Adapter Machine Expanded Galv 0,7mm 180QF L=130mm	Europe (non UK)	22023-180		Galv	0,7mm	180							0,32	8210001861
	Adapter Machine Expanded Galv 0,7mm 200QF L=130mm	Europe (non UK)	22023-200		Galv	0,7mm	200							0,36	8210001862
	Adapter Machine Expanded Galv 0,7mm 224QF L=130mm	Europe (non UK)	22023-224		Galv	0,7mm	224							0,42	8210001863

QF adapters and accessories

Image	Short description	Suitable markets (Nordfab)	Legacy Item No.	Length (for import)	Material	Material Thickness	Diameter A	Diameter B	End Type B	Inner dimension (ID)	Outer dimension (OD)	Rolled Edge (mm)	Length	Weight	Model
	Adapter Machine Expanded Galv 0,7mm 250QF L=130mm	Europe (non UK)	22023-250		Galv	0,7mm	250							0,44	8210001864
	Adapter Machine Expanded Galv 0,7mm 300QF L=130mm	Europe (non UK)	22023-300		Galv	0,7mm	300							0,52	8210001865
	Adapter Machine Expanded Galv 0,7mm 100QF L=130mm	Europe (non UK)	22023-100		Galv	0,7mm	100							0,12	8210001856
	Adapter Nipple QF to FB Galv 0,7mm 80QF 80FB	Europe (non UK)	22015-080		Galv	0,7mm	80							0,12	8210001820
	Adapter Nipple QF to FB Galv 0,7mm 100QF 100FB	Europe (non UK)	22015-100		Galv	0,7mm	100							0,1	8210001821
	Adapter Nipple QF to FB Galv 0,7mm 125QF 125FB	Europe (non UK)	22015-125		Galv	0,7mm	125							0,13	8210001822
	Adapter Nipple QF to FB Galv 0,7mm 140QF 140FB	Europe (non UK)	22015-140		Galv	0,7mm	140							0,14	8210001823
	Adapter Nipple QF to FB Galv 0,7mm 150QF 150FB	Europe (non UK)	22015-150		Galv	0,7mm	150							0,18	8210001824
	Adapter Nipple QF to FB Galv 0,7mm 160QF 160FB	Europe (non UK)	22015-160		Galv	0,7mm	160							0,2	8210001825
	Adapter Nipple QF to FB Galv 0,7mm 180QF 180FB	Europe (non UK)	22015-180		Galv	0,7mm	180							0,23	8210001826
	Adapter Nipple QF to FB Galv 0,7mm 200QF 200FB	Europe (non UK)	22015-200		Galv	0,7mm	200							0,26	8210001827
	Adapter Nipple QF to FB Galv 0,7mm 224QF 224FB	Europe (non UK)	22015-224		Galv	0,7mm	224							0,3	8210001828
	Adapter Nipple QF to FB Galv 0,7mm 250QF 250FB	Europe (non UK)	22015-250		Galv	0,7mm	250							0,31	8210001829
	Adapter Nipple QF to FB Galv 0,7mm 300QF 300FB	Europe (non UK)	22015-300		Galv	0,7mm	300							0,4	8210001830

QF adapters and accessories

Image	Short description	Suitable markets (Nordfab)	Legacy Item No.	Length (for import)	Material	Material Thickness	Diameter A	Diameter B	End Type B	Inner dimension (ID)	Outer dimension (OD)	Rolled Edge (mm)	Length	Weight	Model
	Adapter Nipple QF to FB Galv 0,7mm 315QF 315FB	Europe (non UK)	22015-315		Galv	0,7mm	315							0,44	8210001831
	Adapter Nipple QF to FB Galv 0,7mm 350QF 350FB	Europe (non UK)	22015-350		Galv	0,7mm	350							0,44	8210001832
	Adapter Nipple QF to FB Galv 0,9mm 400QF 400FB	Europe (non UK)	22015-400		Galv	0,9mm	400							0,54	8210001833
	Adapter Nipple QF to FB Galv 0,9mm 450QF 450FB	Europe (non UK)	22015-450		Galv	0,9mm	450							0,59	8210001834
	Adapter Nipple QF to FB Galv 0,9mm 500QF 500FB	Europe (non UK)	22015-500		Galv	0,9mm	500							0,63	8210001835
	Adapter Nipple QF to FB Galv 0,9mm 630QF 630FB	Europe (non UK)	22015-630		Galv	0,9mm	630							1	8210001836
	End Cap Mesh Galv 0,7mm 80QF	Europe (non UK)	22022-080		Galv	0,7mm	80			78	79	6	50	0,15	8210001031
	End Cap Mesh Galv 0,7mm 100QF	Europe (non UK)	22022-100		Galv	0,7mm	100			97	98	6	50	0,17	8210001032
	End Cap Mesh Galv 0,7mm 125QF	Europe (non UK)	22022-125		Galv	0,7mm	125			123	124	6	50	0,20	8210001033
	End Cap Mesh Galv 0,7mm 140QF	Europe (non UK)	22022-140		Galv	0,7mm	140			138	139	6	50	0,22	8210001034
	End Cap Mesh Galv 0,7mm 150QF	Europe (non UK)	22022-150		Galv	0,7mm	150			147	148	6	50	0,23	8210001035
	End Cap Mesh Galv 0,7mm 160QF	Europe (non UK)	22022-160		Galv	0,7mm	160			158	159	6	50	0,24	8210001036
	End Cap Mesh Galv 0,7mm 180QF	Europe (non UK)	22022-180		Galv	0,7mm	180			178	179	8	50	0,28	8210001037
	End Cap Mesh Galv 0,7mm 200QF	Europe (non UK)	22022-200		Galv	0,7mm	200			199	200	8	50	0,30	8210001038
	End Cap Mesh Galv 0,7mm 224QF	Europe (non UK)	22022-224		Galv	0,7mm	224			223	224	8	50	0,33	8210001039















QF adapters and accessories

Image	Short description	Suitable markets (Nordfab)	Legacy Item No.	Length (for import)	Material	Material Thickness	Diameter A	Diameter B	End Type B	Inner dimension (ID)	Outer dimension (OD)	Rolled Edge (mm)	Length	Weight	Model
	End Cap Mesh Galv 0,7mm 250QF	Europe (non UK)	22022-250		Galv	0,7mm	250			249	250	8	50	0,37	8210001040
	End Cap Mesh Galv 0,7mm 300QF	Europe (non UK)	22022-300		Galv	0,7mm	300			297	297	10	50	0,44	8210001041
	End Cap Mesh Galv 0,7mm 315QF	Europe (non UK)	22022-315		Galv	0,7mm	315			312	313	10	50	0,46	8210001042
	End Cap Mesh Galv 0,7mm 350QF	Europe (non UK)	22022-350		Galv	0,7mm	350			347	348	10	50	0,51	8210001043
	End Cap Mesh Galv 0,9mm 400QF	Europe (non UK)	22022-400		Galv	0,9mm	400			398	400	10	50	0,73	8210001044
	End Cap Mesh Galv 0,9mm 450QF	Europe (non UK)	22022-450		Galv	0,9mm	450			447	449	10	50	0,82	8210001045
	End Cap Mesh Galv 0,9mm 500QF	Europe (non UK)	22022-500		Galv	0,9mm	500			497	499	10	50	1,02	8210001046
	End Cap Mesh Galv 0,9mm 560QF	Europe (non UK)	22022-560		Galv	0,9mm	560			557	559	10	50	1,02	8210001047
	End Cap Mesh Galv 0,9mm 630QF	Europe (non UK)	22022-630		Galv	0,9mm	630			627	629	10	50	1,16	8210001048
	End Cap Mesh Galv 0,9mm 710QF	Europe (non UK)	22022-710		Galv	0,9mm	710			707	709	10	50	1,30	8210001049
	Adapter Smooth Galv 0,7mm 80QF	Thailand (Asia)	22010-080	58	Galv	0,7mm	80							0,1	8210000068
	Adapter Smooth Galv 0,7mm 100QF	Thailand (Asia)	22010-100	58	Galv	0,7mm	100							0,12	8210000069
	Adapter Smooth Galv 0,7mm 125QF	Thailand (Asia)	22010-125	58	Galv	0,7mm	125							0,15	8210000070
	Adapter Smooth Galv 0,7mm 140QF	Thailand (Asia)	22010-140	58	Galv	0,7mm	140							0,17	8210000071
	Adapter Smooth Galv 0,7mm 150QF	Thailand (Asia)	22010-150	58	Galv	0,7mm	150							0,18	8210000072







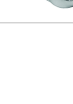







QF adapters and accessories

Image	Short description	Suitable markets (Nordfab)	Legacy Item No.	Length (for import)	Material	Material Thickness	Diameter A	Diameter B	End Type B	Inner dimension (ID)	Outer dimension (OD)	Rolled Edge (mm)	Length	Weight	Model
	Adapter Smooth Galv 0,7mm 160QF	Thailand (Asia)	22010-160	58	Galv	0,7mm	160							0,19	8210000073
	Adapter Smooth Galv 0,7mm 180QF	Thailand (Asia)	22010-180	58	Galv	0,7mm	180							0,23	8210000074
	Adapter Smooth Galv 0,7mm 200QF	Thailand (Asia)	22010-200	58	Galv	0,7mm	200							0,25	8210000075
	Adapter Smooth Galv 0,7mm 224QF	Thailand (Asia)	22010-224	58	Galv	0,7mm	224							0,28	8210000076
	Adapter Smooth Galv 0,7mm 250QF	Thailand (Asia)	22010-250	58	Galv	0,7mm	250							0,32	8210000077
	Adapter Smooth Galv 0,7mm 300QF	Thailand (Asia)	22010-300	58	Galv	0,7mm	300							0,39	8210000078
	Adapter Smooth Galv 0,7mm 315QF	Thailand (Asia)	22010-315	58	Galv	0,7mm	315							0,41	8210000079
	Adapter Smooth Galv 0,7mm 350QF	Thailand (Asia)	22010-350	58	Galv	0,7mm	350							0,46	8210000080
	Adapter Smooth Galv 0,9mm 400QF	Thailand (Asia)	22010-400	58	Galv	0,9mm	400							0,68	8210000081
	Adapter Smooth Galv 0,9mm 450QF	Thailand (Asia)	22010-450	58	Galv	0,9mm	450							0,76	8210000082
	Adapter Smooth Galv 0,9mm 500QF	Thailand (Asia)	22010-500	58	Galv	0,9mm	500							0,84	8210000083
	Adapter Smooth Galv 0,9mm 560QF	Thailand (Asia)	22010-560	58	Galv	0,9mm	560							0,95	8210000084
	Adapter Smooth Galv 0,9mm 630QF	Thailand (Asia)	22010-630	58	Galv	0,9mm	630							1,06	8210000085
	Adapter Smooth Galv 0,9mm 710QF	Thailand (Asia)	22010-710	58	Galv	0,9mm	710							1,2	8210000086
	Adapter Step Edge Galv 0,7mm 80QF	UK	22009-080		Galv	0,7mm	80							0,09	8210000087

QF adapters and accessories

Image	Short description	Suitable markets (Nordfab)	Legacy Item No.	Length (for import)	Material	Material Thickness	Diameter A	Diameter B	End Type B	Inner dimension (ID)	Outer dimension (OD)	Rolled Edge (mm)	Length	Weight	Model
	Drop Out Box Galv 160QF	Europe (non UK)	23050-160	480	Galv		160						480	11,6	8210001915
	Drop Out Box Galv 200QF	Europe (non UK)	23050-200	600	Galv		200						600	16,5	8210001916
	Drop Out Box Galv 250QF	Europe (non UK)	23050-250	750	Galv		250						750	23,6	8210001917
	Drop Out Box Galv 315QF	Europe (non UK)	23050-315	945	Galv		315						945	35	8210001918
	Drop Out Box Galv 350QF	Europe (non UK)	23050-350	1050	Galv		350						1050	67,8	8210001919
	Drop Out Box Galv 400QF	Europe (non UK)	23050-400	1200	Galv		400						1200	67,8	8210001920
	Drop Out Box Galv 500QF	Europe (non UK)	23050-500	1500	Galv		500						1500	98,3	8210001922
	Drop Out Box Galv 560QF	Europe (non UK)	23050-560	1500	Galv		560						1500	120,2	8210001923
	Silencer w/Baffle Galv 300QF L=0,5m	Europe (non UK)	RLBQ-300-05		Galv		300						500	11,55	8210001446
	Silencer w/Baffle Galv 315QF L=2m	Europe (non UK)	RLBQ-315-20		Galv		315						2000	48,2	8210001449
	Silencer w/Baffle Galv 300QF L=2m	Europe (non UK)	RLBQ-300-20		Galv		300						2000	46,2	8210001447
	Silencer w/Baffle Galv 315QF L=0,5m	Europe (non UK)	RLBQ-315-05		Galv		315						500	12,05	8210001448
	Silencer w/Baffle Galv 350QF L=0,5m	Europe (non UK)	RLBQ-350-05		Galv		350						500	12,88	8210001450
	Silencer w/Baffle Galv 350QF L=2m	Europe (non UK)	RLBQ-350-20		Galv		350						2000	51,52	8210001451
	Silencer w/Baffle Galv 400QF L=0,5m	Europe (non UK)	RLBQ-400-05		Galv		400						500	14,7	8210001452















QF adapters and accessories

Image	Short description	Suitable markets (Nordfab)	Legacy Item No.	Length (for import)	Material	Material Thickness	Diameter A	Diameter B	End Type B	Inner dimension (ID)	Outer dimension (OD)	Rolled Edge (mm)	Length	Weight	Model
	Silencer w/Baffle Galv 400QF L=2m	Europe (non UK)	RLBQ-400-20		Galv		400						2000	58,8	8210001453
	Silencer w/Baffle Galv 450QF L=0.5m	Europe (non UK)	RLBQ-450-05		Galv		450						500	16,4	8210001454
	Silencer w/Baffle Galv 450QF L=2m	Europe (non UK)	RLBQ-450-20		Galv		450						2000	65,6	8210001455
	Silencer w/Baffle Galv 500QF L=0.5m	Europe (non UK)	RLBQ-500-05		Galv		500						500	17,85	8210001456
	Silencer w/Baffle Galv 500QF L=2m	Europe (non UK)	RLBQ-500-20		Galv		500						2000	71,4	8210001457
	Silencer w/Baffle Galv 560QF L=0.5m	Europe (non UK)	RLBQ-560-05		Galv		560						500	19,38	8210001458
	Silencer w/Baffle Galv 560QF L=2m	Europe (non UK)	RLBQ-560-20		Galv		560						2000	77,5	8210001459
	Silencer w/Baffle Galv 630QF L=0.5m	Europe (non UK)	RLBQ-630-05		Galv		630						500	20,25	8210001460
	Silencer w/Baffle Galv 630QF L=2m	Europe (non UK)	RLBQ-630-20		Galv		630						2000	81	8210001461
	Silencer w/Baffle Galv 710QF L=0.5m	Europe (non UK)	RLBQ-710-05		Galv		710						500	20,68	8210001462
	Silencer w/Baffle Galv 710QF L=1m	Europe (non UK)	RLBQ-710-10		Galv		710						1000	41,35	8210001463
	Silencer w/o Baffle Galv 100QF L=0.5m	Europe (non UK)	RLDQ-100-05	0,5	Galv		100						500	5,5	8210001508
	Silencer w/o Baffle Galv 100QF L=1m	Europe (non UK)	RLDQ-100-10	1	Galv		100						1000	10,3	8210001509
	Silencer w/o Baffle Galv 140QF L=1m	Europe (non UK)	RLDQ-140-10	1	Galv		140						1000	11,8	8210001512
	Silencer w/o Baffle Galv 180QF L=0.5m	Europe (non UK)	RLDQ-180-05	0,5	Galv		180						500	7,5	8210001517

QF adapters and accessories

Image	Short description	Suitable markets (Nordfab)	Legacy Item No.	Length (for import)	Material	Material Thickness	Diameter A	Diameter B	End Type B	Inner dimension (ID)	Outer dimension (OD)	Rolled Edge (mm)	Length	Weight	Model
	Silencer w/o Baffle Galv 160QF L=2m	Europe (non UK)	RLDQ-160-20	2	Galv		160						2000	26,88	8210001516
	Silencer w/o Baffle Galv 150QF L=0,5m	Europe (non UK)	RLDQ-150-05	0,5	Galv		150						500	6,97	8210001514
	Silencer w/o Baffle Galv 180QF L=1m	Europe (non UK)	RLDQ-180-10	1	Galv		180						1000	14,9	8210001518
	Silencer w/o Baffle Galv 180QF L=2m	Europe (non UK)	RLDQ-180-20	2	Galv		180						2000	29,9	8210001519
	Silencer w/o Baffle Galv 150QF L=2m	Europe (non UK)	RLDQ-150-20	2	Galv		150						2000	25,6	8210001515
	Silencer w/o Baffle Galv 225QF L=2m	Europe (non UK)	RLDQ-225-20	2	Galv		225						2000	33,76	8210001523
	Silencer w/o Baffle Galv 250QF L=2m	Europe (non UK)	RLDQ-250-20	2	Galv		250						2000	35,96	8210001525
	Silencer w/o Baffle Galv 300QF L=0,5m	Europe (non UK)	RLDQ-300-05	0,5	Galv		300						500	10,13	8210001526
	Silencer w/o Baffle Galv 200QF L=0,5m	Europe (non UK)	RLDQ-200-05	0,5	Galv		200						500	8	8210001520
	Silencer w/o Baffle Galv 250QF L=0,5m	Europe (non UK)	RLDQ-250-05	0,5	Galv		250						500	8,99	8210001524
	Silencer w/o Baffle Galv 300QF L=2m	Europe (non UK)	RLDQ-300-20	2	Galv		300						2000	40,52	8210001527
	Silencer w/o Baffle Galv 200QF L=2m	Europe (non UK)	RLDQ-200-20	2	Galv		200						2000	30,7	8210001521
	Silencer w/o Baffle Galv 225QF L=0,5m	Europe (non UK)	RLDQ-225-05	0,5	Galv		225						500	8,44	8210001522
	Silencer w/o Baffle Galv 315QF L=0,5m	Europe (non UK)	RLDQ-315-05	0,5	Galv		315						500	10,63	8210001528
	Silencer w/o Baffle Galv 315QF L=2m	Europe (non UK)	RLDQ-315-20	2	Galv		315						2000	42,5	8210001529







QF adapters and accessories

Image	Short description	Suitable markets (Nordfab)	Legacy Item No.	Length (for import)	Material	Material Thickness	Diameter A	Diameter B	End Type B	Inner dimension (ID)	Outer dimension (OD)	Rolled Edge (mm)	Length	Weight	Model
	Silencer w/o Baffle Galv 350QF L=0.5m	Europe (non UK)	RLDQ-350-05	0,5	Galv		350						500	11,32	8210001530
	Silencer w/o Baffle Galv 400QF L=2m	Europe (non UK)	RLDQ-400-20	2	Galv		400						2000	51,04	8210001533
	Silencer w/o Baffle Galv 450QF L=0.5m	Europe (non UK)	RLDQ-450-05	0,5	Galv		450						500	14,23	8210001534
	Silencer w/o Baffle Galv 450QF L=2m	Europe (non UK)	RLDQ-450-20	2	Galv		450						2000	57,02	8210001535
	Silencer w/o Baffle Galv 500QF L=0.5m	Europe (non UK)	RLDQ-500-05	0,5	Galv		500						500	15,26	8210001536
	Silencer w/o Baffle Galv 500QF L=2m	Europe (non UK)	RLDQ-500-20	2	Galv		500						2000	61,02	8210001537
	Silencer w/o Baffle Galv 560QF L=0.5m	Europe (non UK)	RLDQ-560-05	0,5	Galv		560						500	15,5	8210001538
	Silencer w/o Baffle Galv 560QF L=2m	Europe (non UK)	RLDQ-560-20	2	Galv		560						2000	64,2	8210001539
	Silencer w/o Baffle Galv 630QF L=0.5m	Europe (non UK)	RLDQ-630-05	0,5	Galv		630						500	19,02	8210001540
	Silencer w/o Baffle Galv 710QF L=0.5m	Europe (non UK)	RLDQ-710-05	0,5	Galv		710						500	22,2	8210001541
	Silencer w/o Baffle Galv 710QF L=1m	Europe (non UK)	RLDQ-710-10	1	Galv		710						1000	43,26	8210001542
	Silencer w/Baffle Galv 300QF L=1m	Europe (non UK)	RLBQ-300-10		Galv		300						1000	23,1	8210003679
	Silencer w/Baffle Galv 315QF L=1m	Europe (non UK)	RLBQ-315-10		Galv		315						1000	24,1	8210003680
	Silencer w/Baffle Galv 350QF L=1m	Europe (non UK)	RLBQ-350-10		Galv		350						1000	25,76	8210003681
	Silencer w/Baffle Galv 400QF L=1m	Europe (non UK)	RLBQ-400-10		Galv		400						1000	29,4	8210003682

QF adapters and accessories

Image	Short description	Suitable markets (Nordfab)	Legacy Item No.	Length (for import)	Material	Material Thickness	Diameter A	Diameter B	End Type B	Inner dimension (ID)	Outer dimension (OD)	Rolled Edge (mm)	Length	Weight	Model
	Silencer w/Baffle Galv 450QF L=1m	Europe (non UK)	RLBQ-450-10		Galv		450						1000	32,8	8210003 683
	Silencer w/Baffle Galv 500QF L=1m	Europe (non UK)	RLBQ-500-10		Galv		500						1000	35,7	8210003 684
	Silencer w/Baffle Galv 560QF L=1m	Europe (non UK)	RLBQ-560-10		Galv		560						1000	38,75	8210003 685
	Silencer w/Baffle Galv 630QF L=1m	Europe (non UK)	RLBQ-630-10		Galv		630						1000	40,5	8210003 686
	Silencer w/Baffle Galv 710QF L=2m	Europe (non UK)	RLBQ-710-20		Galv		710						2000	82,7	8210003 687
	Silencer w/o Baffle Galv 125QF L=0,5m	Europe (non UK)	RLDQ-125-05	0,5	Galv		125						500	5,9	8210003 720
	Silencer w/o Baffle Galv 140QF L=0,5m	Europe (non UK)	RLDQ-140-05	0,5	Galv		140						500	6,14	8210003 722
	Silencer w/o Baffle Galv 160QF L=1m	Europe (non UK)	RLDQ-160-10	1	Galv		160						1000	13,94	8210003 725
	Silencer w/o Baffle Galv 200QF L=1m	Europe (non UK)	RLDQ-200-10	1	Galv		200						1000	15,35	8210003 726
	Silencer w/o Baffle Galv 250QF L=1m	Europe (non UK)	RLDQ-250-10	1	Galv		250						1000	18,58	8210003 728
	Silencer w/o Baffle Galv 300QF L=1m	Europe (non UK)	RLDQ-300-10	1	Galv		300						1000	21,06	8210003 729
	Silencer w/o Baffle Galv 125QF L=1m	Europe (non UK)	RLDQ-125-10	1	Galv		125						1000	10,5	8210003 721
	Silencer w/o Baffle Galv 150QF L=1m	Europe (non UK)	RLDQ-150-10	1	Galv		150						1000	13,94	8210003 723
	Silencer w/o Baffle Galv 225QF L=1m	Europe (non UK)	RLDQ-225-10	1	Galv		225						1000	17,28	8210003 727
	Silencer w/o Baffle Galv 160QF L=0,5m	Europe (non UK)	RLDQ-160-05	0,5	Galv		160						500	7	8210003 724

QF adapters and accessories

Image	Short description	Suitable markets (Nordfab)	Legacy Item No.	Length (for import)	Material	Material Thickness	Diameter A	Diameter B	End Type B	Inner dimension (ID)	Outer dimension (OD)	Rolled Edge (mm)	Length	Weight	Model
	Silencer w/o Baffle Galv 315QF L=1m	Europe (non UK)	RLDQ-315-10	1	Galv		315						1000	22,05	8210003730
	Silencer w/o Baffle Galv 350QF L=1m	Europe (non UK)	RLDQ-350-10	1	Galv		350						1000	23,53	8210003731
	Silencer w/o Baffle Galv 400QF L=1m	Europe (non UK)	RLDQ-400-10	1	Galv		400						1000	28,12	8210003732
	Silencer w/o Baffle Galv 450QF L=1m	Europe (non UK)	RLDQ-450-10	1	Galv		450						1000	31,51	8210003733
	Silencer w/o Baffle Galv 560QF L=1m	Europe (non UK)	RLDQ-560-10	1	Galv		560						1000	37,5	8210003735
	Silencer w/o Baffle Galv 630QF L=1m	Europe (non UK)	RLDQ-630-10	1	Galv		630						1000	40,23	8210003736
	Silencer w/o Baffle Galv 630QF L=2m	Europe (non UK)	RLDQ-630-20	2	Galv		630						2000	73,46	8210003737

QF adapters and accessories

QF Mesh End Cap Dimensions

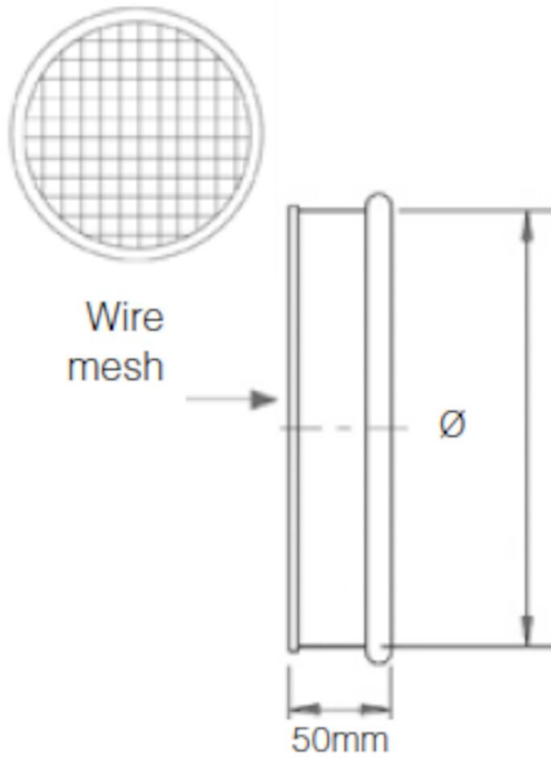

QF Mesh End Cap Dimensions

QF adapters and accessories

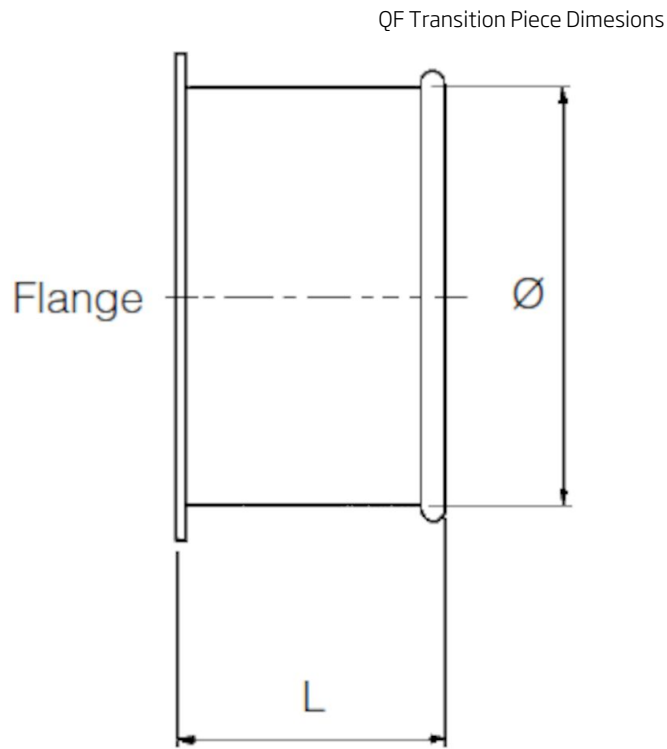

QF Transition Piece Dimesions

QF adapters and accessories

QF Machine adapter dimensions

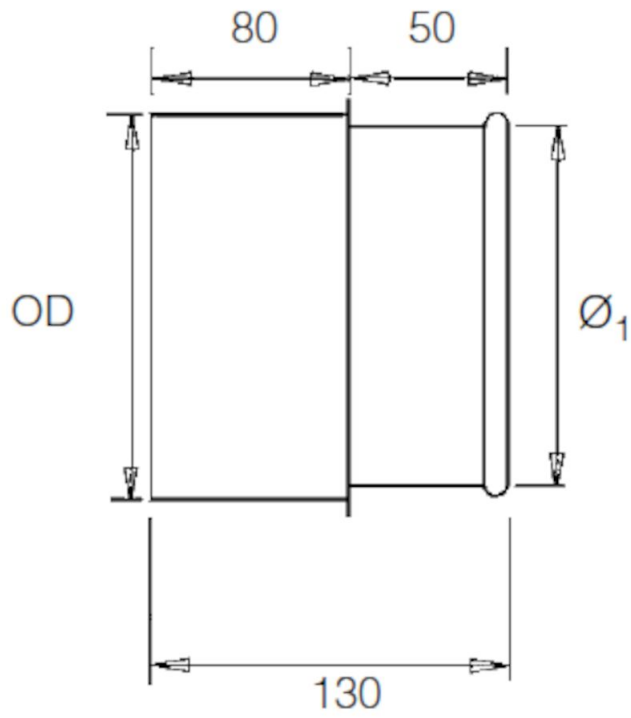

QF Machine adapter dimensions

QF adapters and accessories

QF Ventilation adapter

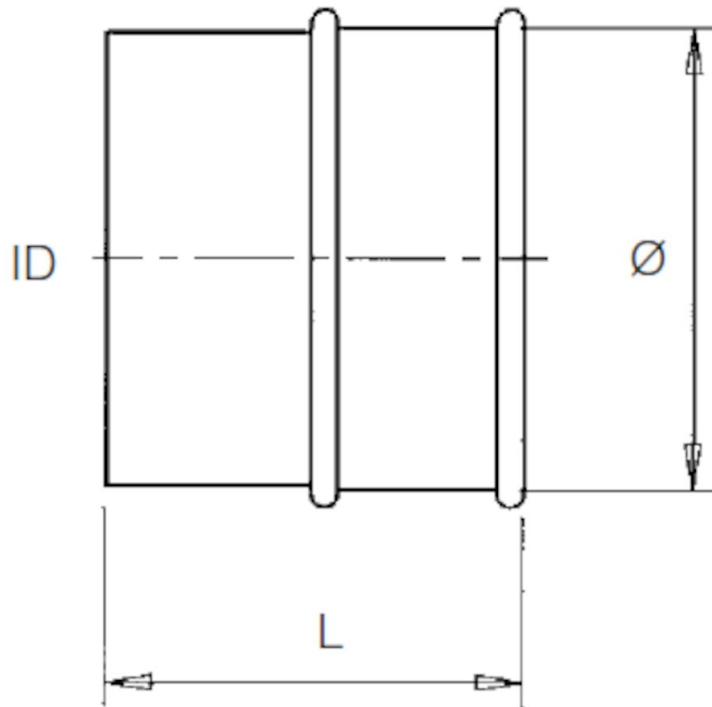

QF Ventilation adapter

QF adapters and accessories

QF Hose adapter dimensions

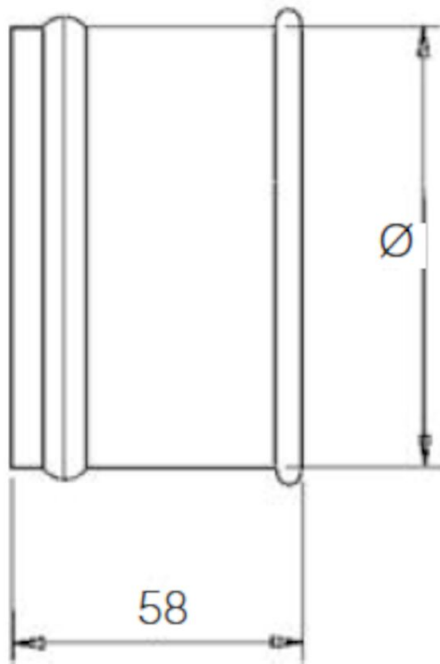

QF Hose adapter dimensions

QF adapters and accessories

QF Tabular rivet adapter dimensions

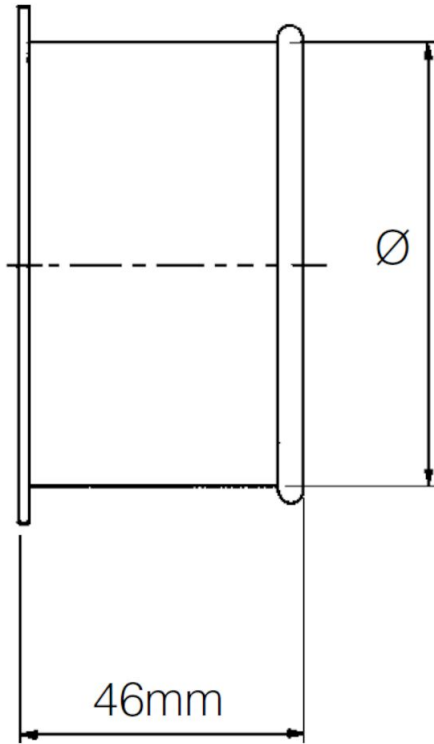

QF Tabular rivet adapter dimensions

QF adapters and accessories

Dimensions Flanged Adapter (QF)

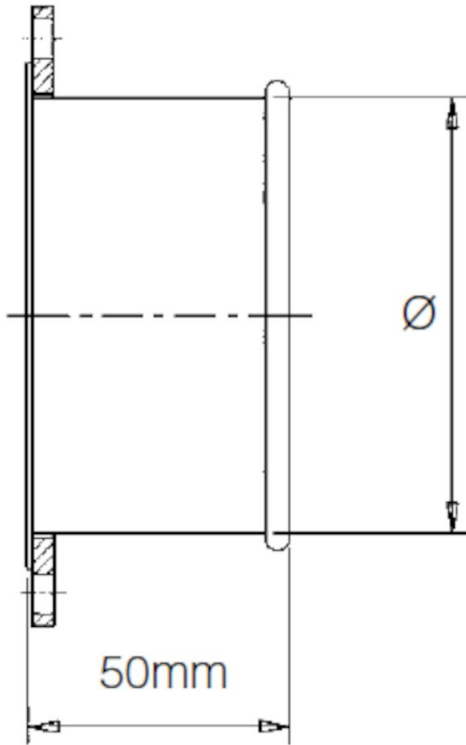

QF Flanged adapter dimensions

QF adapters and accessories

QF Cone for hose connection dimensions

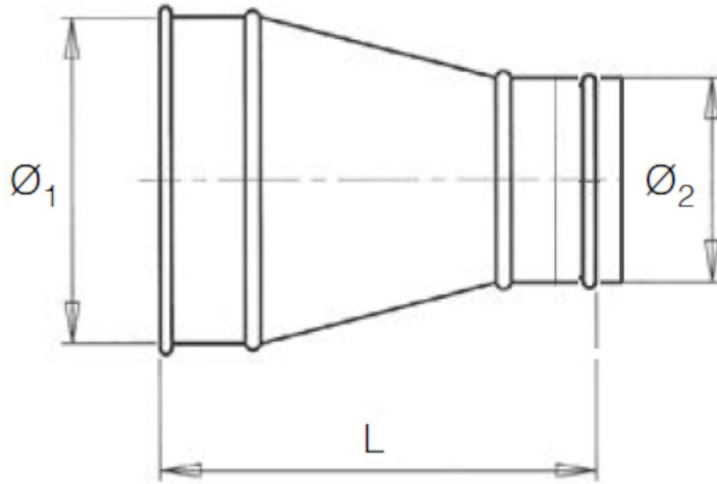

QF Cone for hose connection dimensions

QF adapters and accessories

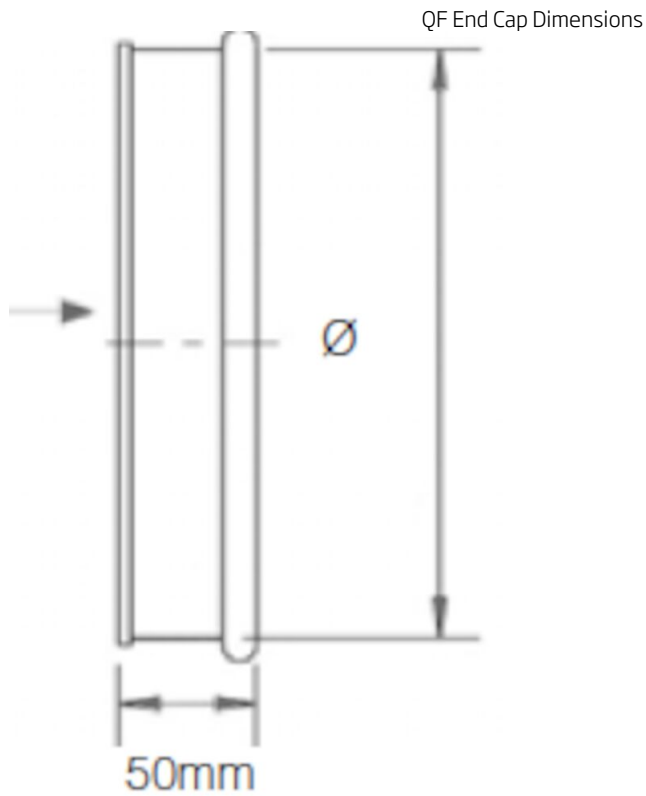

QF End Cap Dimensions, 22012-XXX