

High capacity reel for demanding applications



Nederman Series 884

Heavy duty hose reel for long and heavy hoses. Made of epoxy-coated die-cast aluminium. Ball bearings in drum and swivel. Fully protected inner mechanisms.

- Strong, durable and highly corrosion resistant.
- Smooth hose operation.
- Adjustable outlet arm minimizes friction.

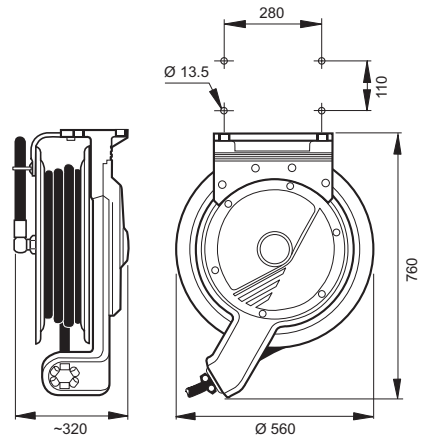

Weight incl. hose: 28 – 35 kg Material recycling: 100 %

Use for	Max. working pressure MPa (psi)	Distribution hose		Connection hose*	Hose material	Hose type (see page 17)	Reel with hose Part no.	Reel without hose Part no.
		Int. Ø mm (in)	Length m	Int. Ø mm (in)				
Air / Water	1.5 (220)	12.5 (1/2)	20	12.5 (1/2)	Rubber	D	30810284	30810184
			30		Rubber	D	30817484	30817384
		19 (3/4)	15	19 (3/4)	Rubber	D	30810484	30810384
		25 (1)	10	25 (1)	Rubber	D	30810684	30810584
Water – food grade hose	1.5 (220)	12.5 (1/2)	20	12.5 (1/2)	Rubber	E	30810884	–
		19 (3/4)	15	19 (3/4)	Rubber	E	30811284	30812184
		25 (1)	10	25 (1)	Rubber	E	30811484	30813384
HP water	20 (2900)	10 (3/8)	25	10 (3/8)	Rubber	G	30811684	30811584
Oil	7.5 (1090)	12.5 (1/2)	20	12.5 (1/2)	Rubber	I	30811884	30811784
			30		Rubber	I	30813684	30813584
	5.0 (725)	19 (3/4)	15	19 (3/4)	Rubber	I	30812284	30812184
		25 (1)	10	25 (1)	Rubber	I	30813484	30813384
Diesel**	5.0 (725)	–	–	–	–	–	30814584	
Grease	35 (5075)	6 (1/4)	25	6 (1/4)	Rubber	J	30813284	–

* Connection hose = 1 m long

** For 15 m (3/4") hose. Connections on reel: male 3/4" BSP.