

Backpack for FM filters

The FM Backpack is available in two versions, a single and a double version

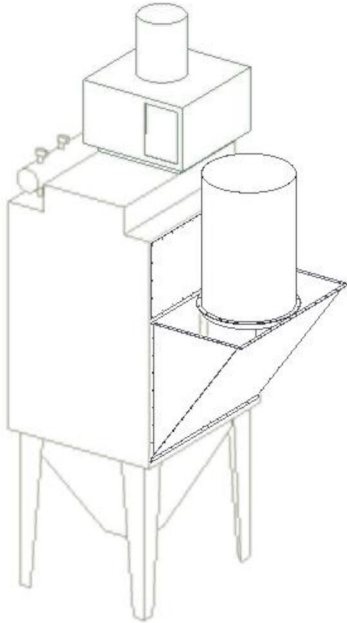

The FM Backpack is available in two versions, a single and a double version. The FM backpack is available for all filter sizes.

FM Backpack Single



The backpack single is used where an upward explosion relief is wanted. The backpack single can also be used in applications where the inlet has to be extra large because of the large air flow into the filter. In cases where the dust is extremely abrasive and the inlet speed is very low, the backpack single can be used as well.

FM Backpack Double

The backpack double is used to connect several filters into one filter. Here the explosion relief can be upward as well.

Nombre de producto	Backpack for FM filters
--------------------	-------------------------

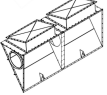
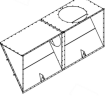
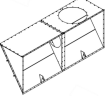
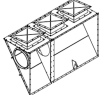
Backpack for FM filters

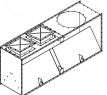
Imagen	Nombre para ficha de datos	Modelo
	Single backpack for 4 modules	5509660
	Single backpack for 8 modules inlet L, D=400 QF, two relief panels	5509662
	Single backpack for 8 modules round inlet from the top pos L	5501169
	Single backpack for 8 modules round inlet from the top pos R	5501170
	Single backpack for 6 modules inlet L, D=400 QF, three relief panels	5512286
	Double backpack for 4 modules	5509661
	Double backpack for 8 modules two relief panels and round inlet from the top	5509663

Backpack for FM filters

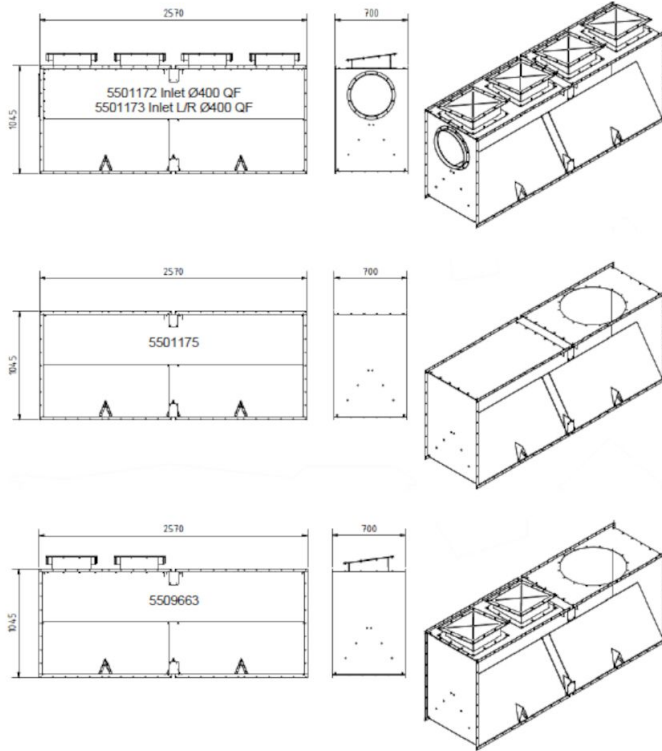

Backpack for FM filters

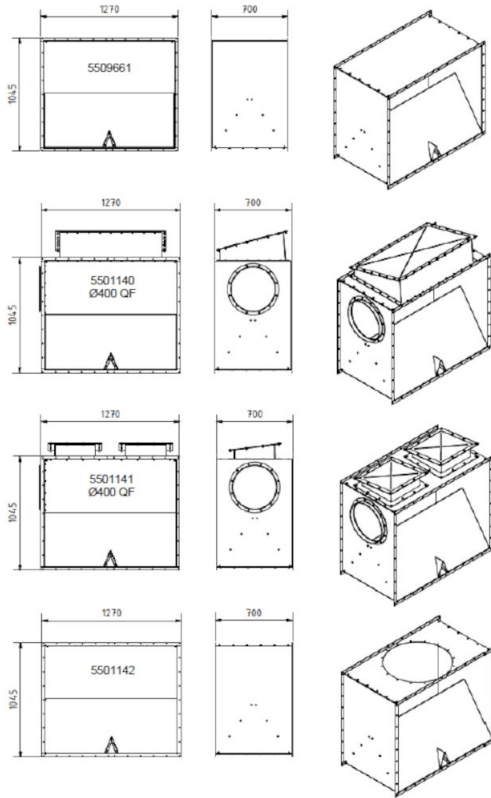

Backpack for FM filters

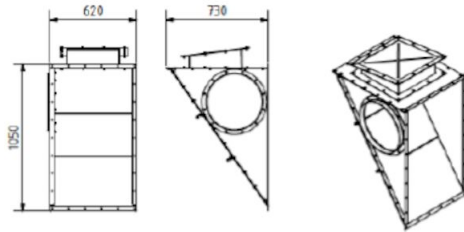

5512283 Inlet L Ø400 QF*
5512284 Inlet R Ø400 QF*

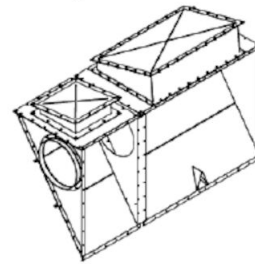
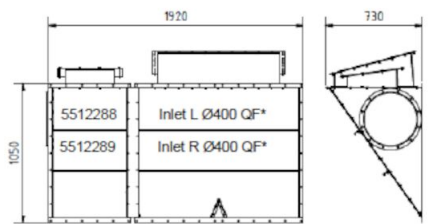
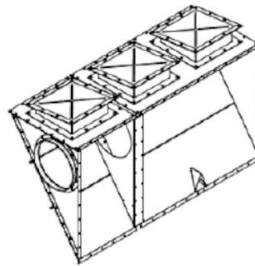
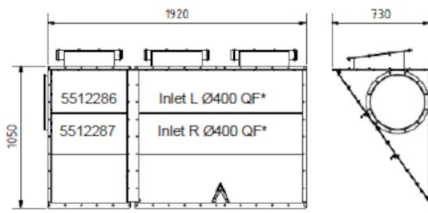

*) seen from the back site of the filter

Backpack for FM filters

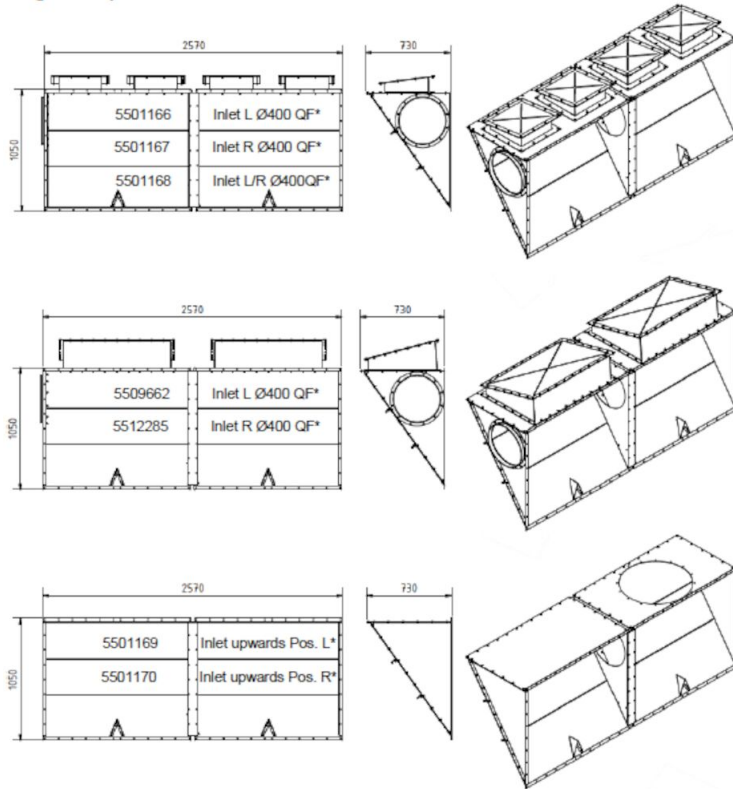

*) seen from the back site of the filter

Backpack for FM filters

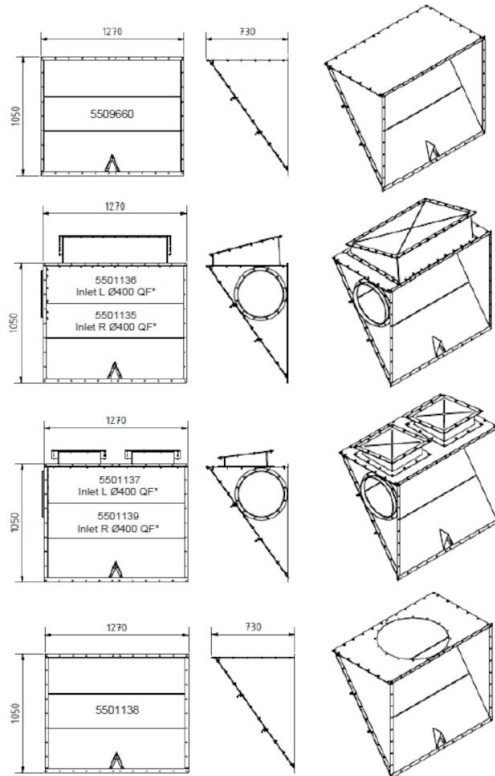

*seen from the back site of the filter

*) seen from the back site of the filter