

Základna pro FM filtry

Je možné dodat platformu pro všechny typy filtračních jednotek FM

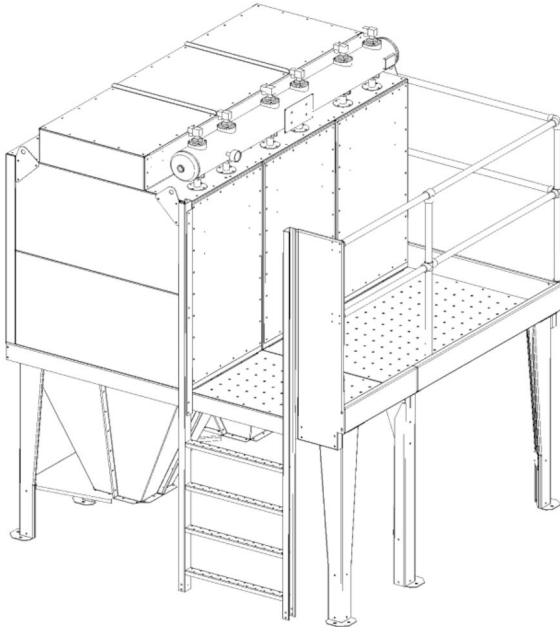







K dispozici jsou platformy pro každou velikost filtru FM. Platforma je dostatečně široká.

Popis:

Plošina je vyrobena z pozinkovaných ocelových plátů. Žebřík lze namontovat buď vlevo nebo vpravo. Zábradlí je vyrobeno z 1" galvanizované oceli. Při montáži plošiny musí být podpěry filtru FM namontovány podél předního okraje plošiny. Základy musí odpovídat rozměrům plošiny a filtru.

Název produktu	Základna pro FM filtry
----------------	------------------------

Základna pro FM filtry

[image]	Jméno datasheetu	Hmotnost (kg)	[model]
	Platform for FM filter with 2 modules	85	5501356
	Platform for FM filter with 4 modules	119	5501357
	Platform for FM filter with 6 modules	149	5501358
	Platform for FM filter with 8 modules	177	5501359
	Platform for FM filter with 6 modules, single outlet hopper	149	5501373
	Platform for FM filter with 8 modules, single outlet hopper	177	5501374

Základna pro FM filtry

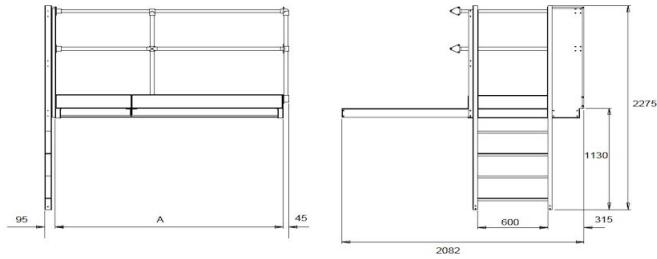

Filter size	A (mm)
FM – 2 modules	655
FM – 4 modules	1,304
FM – 6 modules	1,955
FM – 8 modules	2,605
FM – 6 module single outlet hopper	1,955
FM – 8 module single outlet hopper	2,605

* The specified weight is for a standard ladder. Add 28 kg per extra 2 m ladder.