

NRS rotary valves, type 4,10,20,30 and 10-Q

Continuous emptying of the dust collector hopper

NRS rotary valves, type 4,10,20,30 and 10-Q

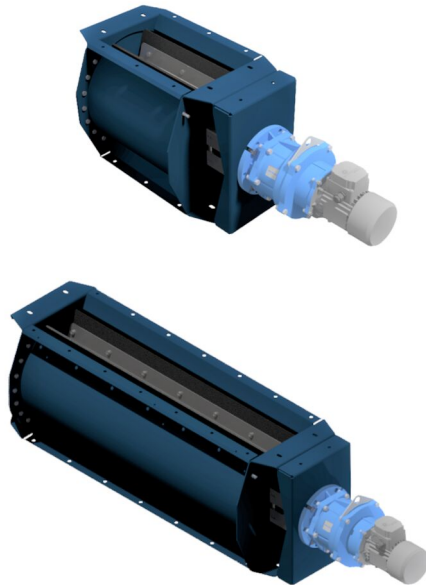

The NRS type rotary valve is used to transfer material between two separate systems. In pneumatic conveying systems discharge is usually required from the filter or cyclone to the silo, at atmospheric pressure. This is an ideal application for the NRS type rotary valve.

The rotary valve can be used for most material types, though the particle size must not exceed 13 x 13 x 13 mm (.5 x .5 x .5 in).

The NRS type rotary valve is modular and robustly constructed in heavy steel plate. The rotor of each module is equipped with an elastic clutch. This reduces the possibility of damage in use and maximises the life of the unit. The rotor has special rubber seals, which provide an effective air lock between the inlet and the outlet.

- The NRS type rotary valve is used to transfer material between two separate systems. In pneumatic conveying systems discharge is usually required from the filter or cyclone to the silo, at atmospheric pressure. This is an ideal application for the NRS type rotary valve.

The rotary valve can be used for most material types, though the particle size must not exceed 13 x 13 x 13 mm (.5 x .5 x .5 in).

The NRS type rotary valve is modular and robustly constructed in heavy steel plate. The rotor of each module is equipped with an elastic clutch. This reduces the possibility of damage in use and maximises the life of the unit. The rotor has special rubber seals, which provide an effective air lock between the inlet and the outlet.

This type of rotary valve is also available in an ATEX certified version for explosive dusts type St1 and St2. The NRSZ is a protective system according to ATEX definition.

- Long lifetime. The rotor is equipped with an elastic clutch, which reduces the possibility of damage in use and maximizes the life of the unit.
- Effective air lock between the inlet and outlet provided due to the special rubber blends.

Product name	NRS rotary valves, type 4,10,20,30 and 10-Q
Noise level (dB(A))	< 70
Installation	[Outdoor], [Indoor]
Material	Heavy steel plate
Suitable for combustible dust	False
Application	[dust]
Operating Temperature	-4 to 104 F (-20 to 40 C)



Dust

NRS rotary valves, type 4,10,20,30 and 10-Q

NRS rotary valves, type 4,10,20,30 and 10-Q

Weight (lbs)	Power (Hp)	[model]
50		73009015*
67	0,18	73009016**
67	0,75	73009018***
107		73009019****
124	0,75	73009021*****
214		73009022*****
243	0,75	73009024*****
321		73009025*****
338	0,75	73009027*****

*Without motor. Capacity at 100% filling - 2 m³/h per RPM

**Capacity at 100% filling - 14 m³/h

***Capacity at 100% filling - 65 m³/h

****Without motor. Capacity at 100% filling - 4,9 m³/h per RPM

*****Capacity at 100% filling - 157 m³/h

*****Without motor. Capacity at 100% filling 9,8 m³/h per RPM

*****Capacity at 100% filling - 314 m³/h

*****Without motor. Capacity at 100% filling - 14,7 m³/h per RPM

*****Capacity at 100% filling - 471 m³/h

NRS rotary valves, type 4,10,20,30 and 10-Q

Leakage

The leakage of the rotary valve during shutdown (S) and during operation (R) depends on the pressure drop over the rotor. See the chart:

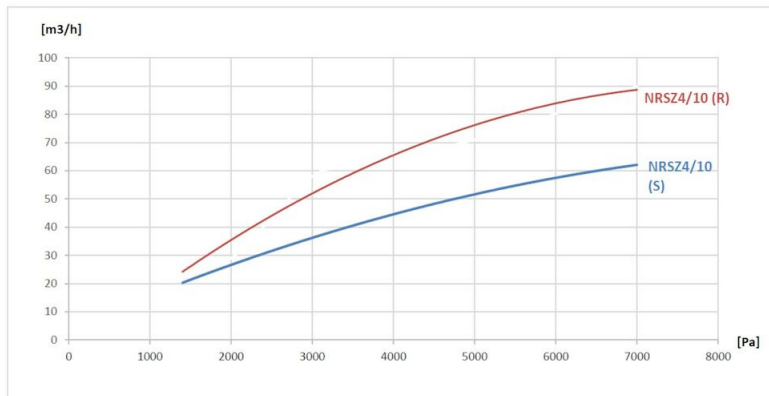

Dimensions NRS 4 / NRSZ 4

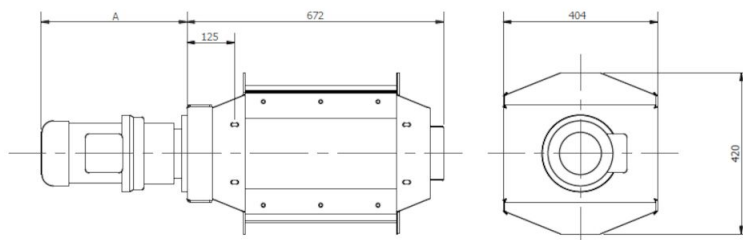

NRS rotary valves, type 4,10,20,30 and 10-Q

Dimensions inlet NRS 4 / NRSZ 4

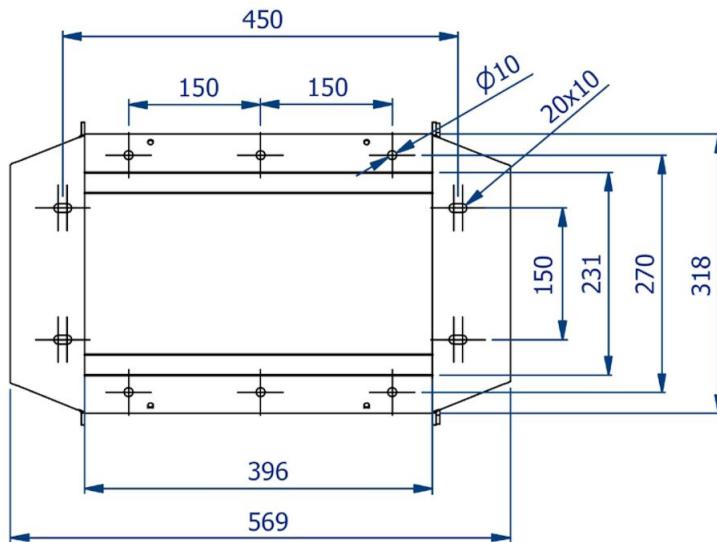

Dimensions NRS 10 / NRSZ 10

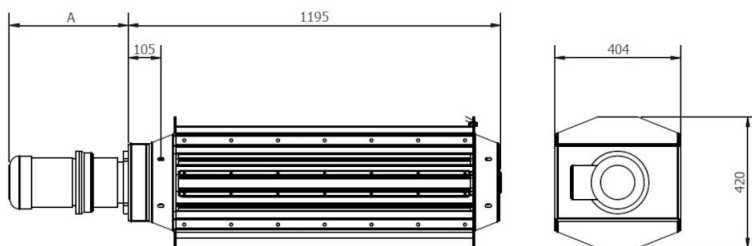

NRS rotary valves, type 4,10,20,30 and 10-Q

Dimensions inlet NRS 10 / NRSZ 10

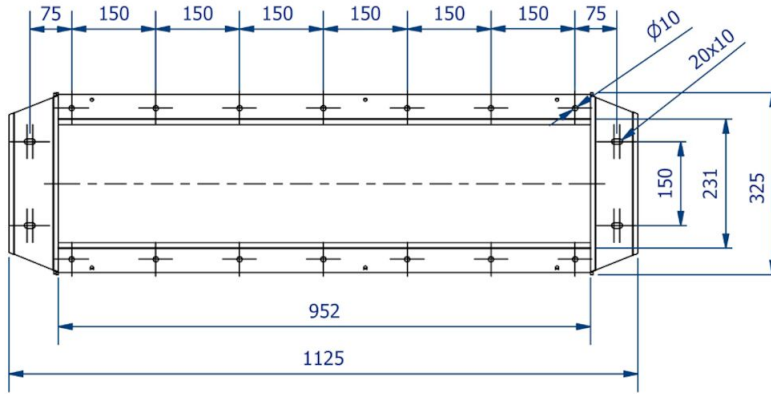

Dimensions NRS 20 / NRSZ 20

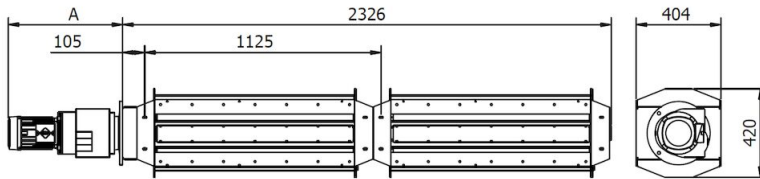

Dimensions NRS 30 / NRSZ 30

