

NRS rotary valves type 4,10,20 and 30

Continuous emptying of the dust collector hopper.

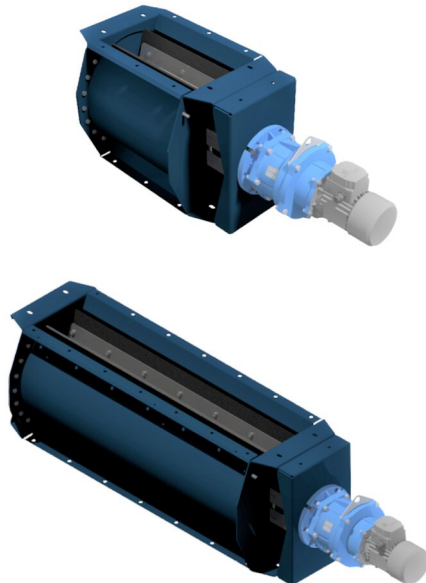

The NRS type rotary valve is used to transfer material between two separate systems. In pneumatic conveying systems, discharge is usually required from the filter or cyclone to the silo, at atmospheric pressure. This is an ideal application for the NRS type rotary valve.

The rotary valve can be used for emptying of several non-adhesive material types. Max. particle size for the NRSZ is 13 x 13 x 13 mm. The rotary valve should not work with highly abrasive dust.

- Robust construction.
- Long lifetime. The rotor is equipped with an elastic clutch, which reduces the possibility of damage in use and maximizes the life of the unit.
- Effective air lock between the inlet and outlet provided due to the special rubber blends.

Nom du produit	NRS rotary valves type 4,10,20 and 30
Niveau sonore (dB(A))	< 70
Installation	Extérieur, Intérieur
Matériel	Heavy steel plate
Convient pour les poussières combustibles	False
Application	Poussière
Operating Temperature	Max. 70°C



NRS rotary valves type 4,10,20 and 30

Poids (kg)	Puissance (kW)	[model]
50		73009015*
67	0,18	73009016**
67	0,75	73009018***
107		73009019****
124	0,75	73009021*****
214		73009022*****
243	0,75	73009024*****
321		73009025*****
338	0,75	73009027*****

*Without motor. Capacity at 100% filling - 2 m³/h per RPM

**Capacity at 100% filling - 14 m³/h

***Capacity at 100% filling - 65 m³/h

****Without motor. Capacity at 100% filling - 4,9 m³/h per RPM

*****Capacity at 100% filling - 157 m³/h

*****Without motor. Capacity at 100% filling 9,8 m³/h per RPM

*****Capacity at 100% filling - 314 m³/h

*****Without motor. Capacity at 100% filling - 14,7 m³/h per RPM

*****Capacity at 100% filling - 471 m³/h

NRS rotary valves type 4,10,20 and 30

	[accessory]	[partno]
	Capteur de rotation pour NRS avec kit d'assemblage	73008689
	Tool for setting the rotor in NRSZ4/10	73008777

NRS rotary valves type 4,10,20 and 30

Leakage

The leakage of the rotary valve during shutdown (S) and during operation (R) depends on the pressure drop over the rotor. See the chart:

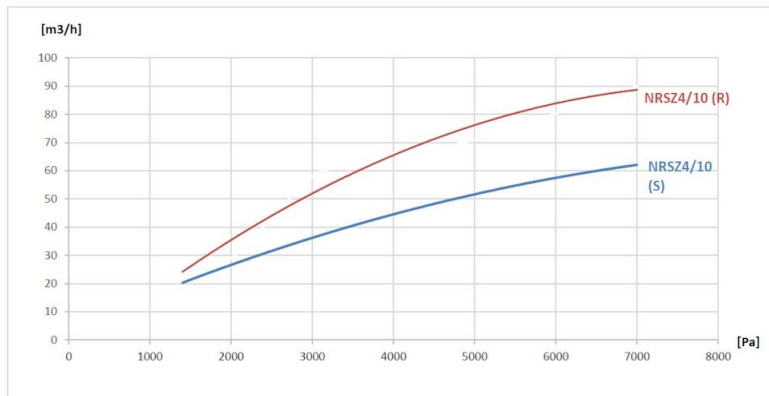

Dimensions NRS 4 / NRSZ 4

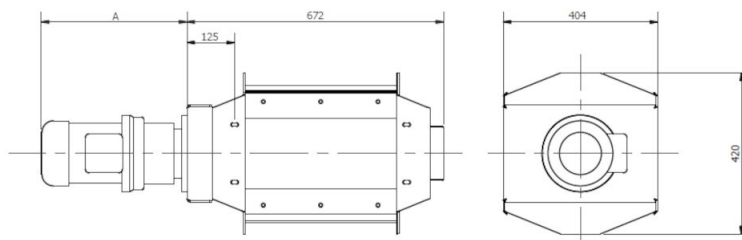

NRS rotary valves type 4,10,20 and 30

Dimensions inlet NRS 4 / NRSZ 4

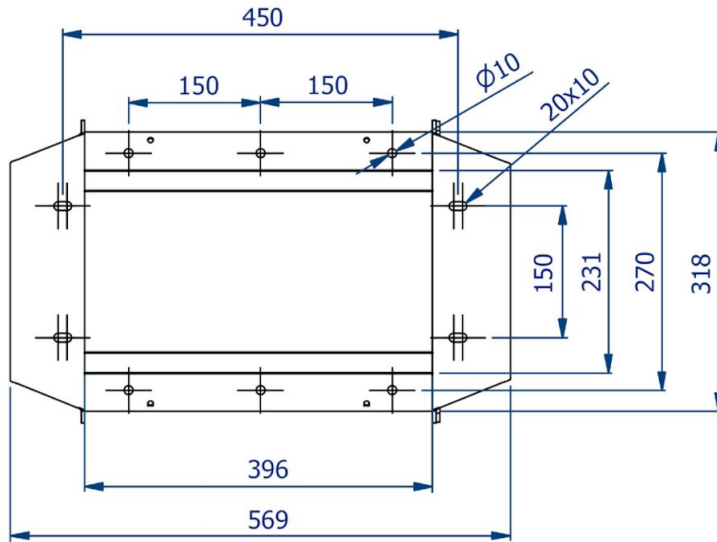

Dimensions NRS 10 / NRSZ 10

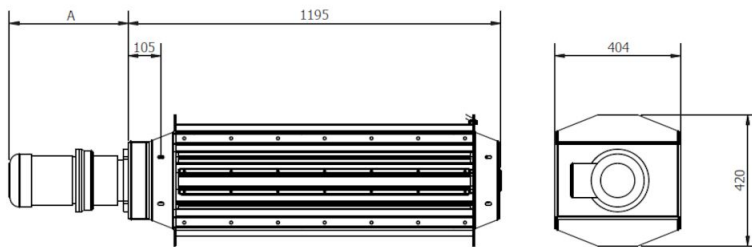

NRS rotary valves type 4,10,20 and 30

Dimensions inlet NRS 10 / NRSZ 10

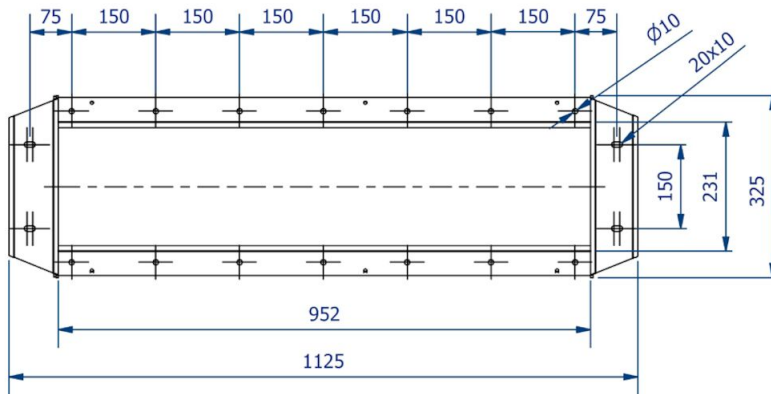

Dimensions NRS 20 / NRSZ 20

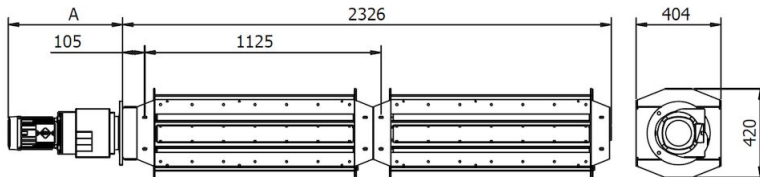

Dimensions NRS 30 / NRSZ 30

