

570A, Configurável

Potente coletor de poeira, excelente para gerar vácuo através de grandes distâncias horizontais ou verticais.

570A, Configurável



The configuration of modules will be similar to 570A which are aimed for the toughest applications, for example handling a lot of abrasive and heavy material. The robustness of the unit and the power from the reliable ejector makes the unit very suitable for many applications where many industrial vacuum cleaners can not be used. For example to collect blasting material in blasting hall, sand recovery in foundries etc.

Your unit can be configured to meet your specific demands. Different ejectors can be used depending on the demand but also the availability of compressed air. The ejector can be placed on a mobile silo with filter, with wheels and forklift slots. Nederman has a range of different discharge valves that can be fitted to the silo for easy discharge of the collected material. If handling larger quantities of material, Nederman recommends using a pre separator before the vacuum unit. See Nederman Engineering Guide for more information.

Use modules linked to 570A, configurable only. You may only choose ejectormodule, filtermodule, silomodule and discharge valve

1. Select ejectormodule depending on required vacuum and air flow.
2. Select filtermodule depending on filter capacity.
3. Select silomodule.
4. Select discharge valve.
5. Select cleaning equipment.

Choose how to control your butterfly valve:

1. Electric controlled - You need a namur valve, solenoid valve recommended for the ejector size you choose and a control box.
2. Air controlled - You need a namur valve.

Hose for air supply to the namur valve is not supplied by Nederman.

Control system with many different functions is available as an accessory

Ensure you meet all requirements for your modules.

- Sistema de Silo com rodas grandes
- Adequado material pesado e abrasivo
- Filtro autolimpante robusto e eficiente

Produto	570A, Configurável
Método de limpeza do filtro	Ar comprimido
Aplicações	Poeira, Granulado, Areia, Granalha
Tipo de filtro	Saco
Número de elementos filtrantes	70
Inlet	Ø76mm



Granulado

Areia







Granalha

Poeira



570A, Configurável























570A, Configurável

Imagem	Descrição	Compressed air requirement	Max airflow (m³/h)	Índice de ruído (dB(A))	Vácuo máx. (kPa)	Peso (kg)	Modelo
	NE64, Ejectormodule with S200 lid and 2 quick couplings	4,3 Nm³/min @ 7 bar	330 Nm³/h	77	-68	18	43051000*
	NE74, Ejectormodule with S200 lid and 2 quick couplings	5,3 Nm³/min @ 7 bar	318 Nm³/h	75	-78	18	43051001*
	NE76, Ejectormodule with S200 lid and 2 quick couplings	5,4 Nm³/min @ 7 bar	690 Nm³/h	78	-48	18	43051002**
	NE96, Ejectormodule with S200 lid and 2 quick couplings	8,6 Nm³/min @ 7 bar	660 Nm³/h	78	-68	18	43051003**
	Filtermodule NCF, 3,15 m² filterarea, 1 S200 Vyon F. MFC					40	43162101
	Filtermodule NCF, 5,25 m² filterarea, 1 S200 Vyon F. MFC					55	43164101
	Mobile S200 Silo with plastic fasteners and abrasion plate. Volume 146 l					80	43470034





















*Recommended with filtermodule 43162101

**Recommended with filtermodule 43164101









570A, Configurável

Acessório		Artigo nº
	Discharge valve manual	43630001*
	Discharge valve with counterweight	43630200*
	Discharge valve, pneumatically operated	43630100*
	Pinch valve DN65	43632001
	Pinch valve DN80	43632100
	Manually operated butterfly discharge valve	43630400**
	Pneumatically operated butterfly discharge valve	43630500**
	Mangueira PU12 Ø 51 L=10m	43832600
	Mangueira PU12 Ø 51 L=5m	43832500
	Mangueira PU12 Ø 51 L=20m	43832300
	Mangueira PU12, Ø51mm x 7,5m com acopladores	43832102***
	Mangueira PU12 Ø 51 L=10m com acopladores	43832200***
	Mangueira PU12 Ø 63 L=5m	43833200
	Mangueira PU12 Ø 63 L=10m	43833001
	Mangueira PU12 Ø 63 L=20m	43833100
	Mangueira PU12 Ø 76 L=10m	43834200
	Mangueira PU12 Ø 76 L=20m	43834300
	Mountingplate for controlbox, S200	43690001
	Control system for ejectors	43220034
	Level control for silo continuous feed out	43251001
	Bin Level indicator (BL) EX	40375269
	Equipamento de limpeza com bocal de chão largura 500 mm com rodas pequenas de nylon Ø51 e tiras de borracha	42932100****

570A, Configurável

Acessório		Artigo nº
	Equipamento de limpeza com bocal de chão largura 400 mm sem rodas, para pavimento seco, com escovas	42932800****
	Equipamento de limpeza com bocal de chão largura 400 mm com rodas grandes de borracha Ø51 e tiras de borracha	42932300****
	Bocal para chão, largura 500 mm com rodas de nylon pequenas, Ø51mm	43840150*****
	Bocal para chão, largura 400 mm com rodas de borracha grandes, Ø51mm	43840250*****
	Bocal para chão, largura 400 mm sem rodas para sucção de secos, Ø51mm	43840550*****
	Bocal manual, escova dura, Ø90 mm, Ø51mm	43860001****
	Bocal com dentes largura 130mm, Ø51mm	43861001*****
	Bocal cônico, comprimento 250 mm, Ø51mm	43862001*****
	Tubo cotovelo, Ø51mm	43842150*****
	Tubo de limpeza, comprimento 1100 mm, Ø51 mm	43842001*****
	Bocal de chão, com pega, para material a granel 1200 x Ø51 mm	43850150*****
	Bocal para material a granel, 910 x Ø51mm	43850001****
	Bocal raspador, comprimento: 1000 mm, Ø51mm	43851150*****
	Bocal raspador, comprimento: 500mm, Ø51mm	43851050*****
	Bocal em aço para limalhas, Ø50 mm, entrada com silenciador	40150030*****
	Bocal para chão, largura 500 mm, Ø63mm	43840400****
	Bocal para material a granel, 910 x Ø63mm, galvanizado.	43850050*****
	Bocal para material a granel, L=910 mm para giratório (43843100), Ø63mm	43850051*****
	Bocal de chão, para material a granel 1200 x Ø63 mm	43850200*****
	Bocal raspador manual, comprimento 1000 mm, Ø63mm	43851200*****
	Tubo de sucção curvo alumínio d63	43843050****
	Acoplador giratório, aço d63	43843100****

570A, Configurável

	Acessório	Artigo nº
	Tubo de sucção em alumínio, Ø63mm	43843001*****
	Bocal raspador manual, comprimento 500 mm, Ø63mm	43851100*****
	Bocal para material a granel, 910 x Ø76mm, galvanizado.	43850100*****
	Bocal de chão, com pega, Ø76 mm	43850250*****
	Bocal raspador manual, comprimento 1000mm, Ø76mm	43851250*****
	Redução cônica d76-63mm, aço inox	43880350
	Redução cônica d76-51mm, aço inox	43880300
	Redução cônica para mangueiras d63-51mm	43880250
	Acoplador de mangueira d63mm	43880100
	Acoplador de mangueira d50mm	43880050
	Acoplador de mangueira d76mm em aço inox	43880150
	Control S for NE 22-76	43220001
	Control S for NE 22-76	43220026
	Control S for NE86-96	43222008
	Bocal de chão d63/600	43840450*****

*Ø150mm Housing and flap in PA. Temp range -20C to +40C. Height - 155 mm (240 mm in open position)

**Ø125mm Housing in NBR, Epoxy coated cast iron and flap/sleeve i stainless steel. Temp range -20C to +120C. Height - 110 mm (260 mm in open position)

***Couplings included, Ø 51 mm

****ATEX - Adequado para poeira combustível (zona 20,21,22). Assegurar ligação à terra da unidade de extração. Não deve ser usado em atmosferas com gás combustível ou extração de materiais explosivos.

*****ATEX - This product is suitable to be used as cleaning equipment for combustible dusts with MIE (minimum ignition energy) >1 mJ. Product is to be properly earthed to the extraction unit. Not for usage in combustible gas atmospheres or extraction of explosive materials.

*****ATEX - This product is suitable to be used as cleaning equipment for combustible dusts with MIE (minimum ignition energy) >1 mJ. Product is to be properly earthed to the extraction unit. Not for usage in combustible gas atmospheres or extraction of explosive materials.

*****ATEX - Suitable for combustible dust (zone 20,21,22) and gas (zone 1,2) of group IIA, IIB and IIC. Ensure earthing to extraction unit. Not to be used for extraction of explosive materials

*****Adequado para poeiras combustíveis (zona 20,21,22) e gases (zona 1,2) dos grupos IIA, IIB e IIC. Assegurar ligação à terra da unidade de extração. Não deve ser usado em atmosferas com gás combustível ou extração de materiais explosivos.

570A, Configurável

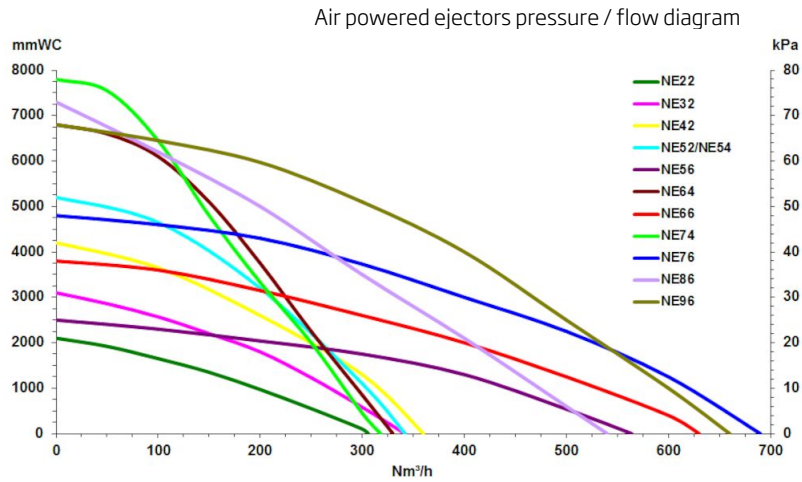

Air Powered ejectors

All performance data are based on 7 bar supply pressure

Ejector/Hose dimension	ø51mm	ø63mm	ø76mm
NE64	2	2,4	N/A
NE74	2,3	2,7	N/A
NE76	1,7	2,7	3,6
NE96	2,6	3,6	4,9

Capacity (tonne/hour) with Blasting media 2,4kg/liter and 20m hose

570A, Configurável

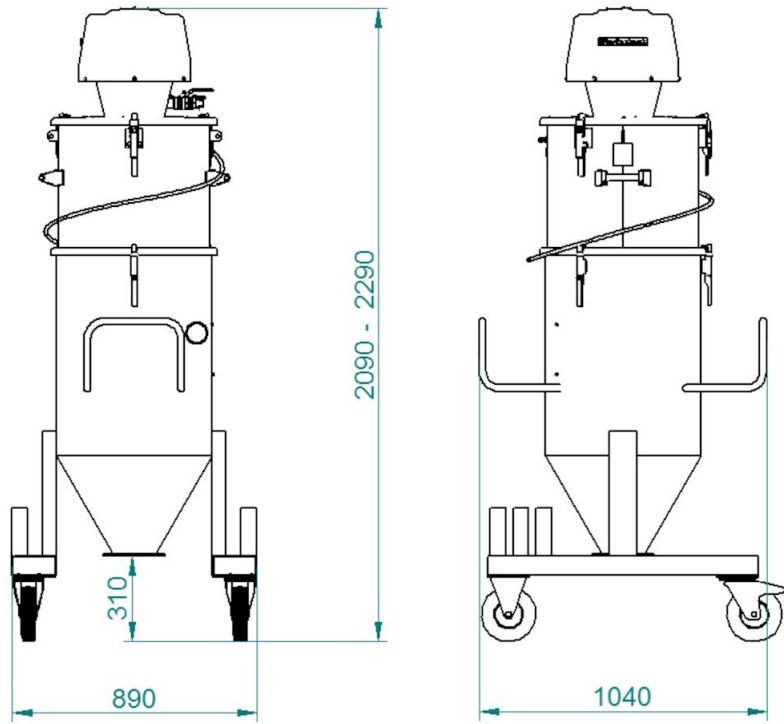

The height of the configuration is depending on filtermodule choosen.