

# 600A, Configurable

A powerful dust collector, for suction over long horizontal and vertical distance

---

## 600A, Configurable



The configuration of modules will be similar to 600A which are aimed for the toughest applications, for example handling a lot of abrasive and heavy material. The robustness of the unit and the power from the reliable ejector makes the unit very suitable for many applications where many industrial vacuum cleaners can not be used. For example to collect blasting material in blasting hall, sand recovery in foundries etc.

Your unit can be configured to meet your specific demands.

Different ejectors can be used depending on the demand but also the availability of compressed air. The ejector can be placed on a stationary silo with filter.

A range of different discharge valves that can be fitted to the silo for easy discharge of the collected material.

If handling larger quantities of material, Nederman recommends using a pre separator before the vacuum unit.

To configure your 600A you may only choose ejectormodule, filtermodule, silomodule and discharge valve listed in this document and with mfc (module for configuration) in title.

1. Select ejectormodule depending on required vacuum and air flow.
2. Select filtermodule depending on filter capacity.
3. Select silomodule.
4. Select discharge valve.
5. Select cleaning equipment.

Choose how to control your butterfly valve:

1. Electric controlled - You need a namur valve, solenoid valve recommended for the ejector size you choose and a control box.
2. Air controlled - You need a namur valve.

Hose for air supply to the namur valve is not supplied by Nederman.

Ensure that all requirements for the modules are met. The height of your configuration is depending on what filtermodule and legs you choose.

- Robust and efficient self-cleaning filter
- Very powerful and reliable ejector as vacuum producer
- Suitable for heavy and/or abrasive material
- Control system with many different functions is available as an accessory

|                           |                                      |
|---------------------------|--------------------------------------|
| Product name              | 600A, Configurable                   |
| Filter cleaning method    | Compressed air                       |
| Application               | [granulate], [grit], [swarf], [dust] |
| Filter type               | [NCF]                                |
| Number of filter elements | 70                                   |



Granulate

Grit









Swarf

Dust



# 600A, Configurable

## 600A, Configurable

| Image   | Description  | Compressed air requirement | Max airflow (m³/h) | Noise level (dB(A)) | Max vacuum (kPa) | Weight (kg) | Model        |
|---|--|----------------------------|--------------------|---------------------|------------------|-------------|--------------|
|    | NE64, Ejectormodule with S200 lid and 2 quick couplings  | 4,3 Nm³/min @ 7 bar        | 330 Nm³/h          | 77                  | -68              | 18          | 43051000*    |
|    | Triangular frame for silo S200                           |                            |                    |                     |                  |             | 43752001     |
|    | Leg straight 1500 mm                                     |                            |                    |                     |                  |             | 43756001**   |
|    | Leg straight 2200 mm                                     |                            |                    |                     |                  |             | 43756100**   |
|    | Stay-tube for legs L > 2200 mm                           |                            |                    |                     |                  |             | 43757001***  |
|   | NE74, Ejectormodule with S200 lid and 2 quick couplings  | 5,3 Nm³/min @ 7 bar        | 318 Nm³/h          | 75                  | -78              | 18          | 43051001*    |
|  | NE76, Ejectormodule with S200 lid and 2 quick couplings  | 5,4 Nm³/min @ 7 bar        | 690 Nm³/h          | 78                  | -48              | 18          | 43051002**** |
|  | NE96, Ejectormodule with S200 lid and 2 quick couplings  | 8,6 Nm³/min @ 7 bar        | 660 Nm³/h          | 78                  | -68              | 18          | 43051003**** |
|  | Filtermodule NCF, 5,25 m² filterarea, 1 S200 Vyon F. MFC |                            |                    |                     |                  | 55          | 43164101     |





















\*Recommended with filtermodule 43162101

\*\*Each configuration needs the quantity of three legs, so to get a complete product you need to order three pieces of chosen number





















\*\*\*To be used with 43756100, order three pieces

\*\*\*\*Recommended with filtermodule 43164101























## 600A, Configurable

| Accessory   |   | Part No      |
|---|---|--------------|
|    | Pneumatically operated butterfly discharge valve              | 43630500*    |
|    | Discharge valve manual  | 43630001**   |
|    | Pinch valve DN65  | 43632001     |
|    | Manually operated butterfly discharge valve                   | 43630400*    |
|    | Pinch valve DN80  | 43632100     |
|    | Pinch valve DN100   | 43632200     |
|    | Discharge valve with counterweight                            | 43630200**   |
|   | Discharge valve, pneumatically operated                       | 43630100**   |
|  | Discharge valve Linatex d100 set with reducer for flange      | 43630300     |
|  | Bagholder for 43630200 or 43631001                            | 43640001     |
|  | Bagholder for 43630100, for pneumatic discharge valve         | 43640003***  |
|   | Plastic bag S50 - 25pcs 630x800                               | 43650104     |
|  | Bagholder big bag with pneumatically operated discharge valve | 43640201     |
|  | Bagholder for big bag, MFC                                    | 43640217**** |
|  | Control S for NE 22-76  | 43220026     |
|  | Control S for NE86-96   | 43222008     |
|  | Control S for NE 22-76  | 43220001     |
|  | Electrical Control system for ejector NE 86                   | 43222001     |
|  | Mountingplate for controlbox, S200                            | 43690001     |
|  | Level control for silo continuous feed out                    | 43251001     |
|  | Hose PU12 Ø 51 L=10m  | 43832600     |
|  | Hose PU12 Ø 51 L=5m   | 43832500     |

## 600A, Configurable

|   | Accessory  | Part No       |
|---|--|---------------|
|    | Hose PU12 Ø 51 L=20m   | 43832300      |
|    | Hose PU12 Ø 51 L=7,5m w. couplings                                   | 43832102***** |
|    | Hose PU12 Ø 51 L=10m w. couplers                                     | 43832200***** |
|    | Hose PU12 Ø 63 L=5m  | 43833200      |
|    | Hose PU12 Ø 63 L=10m   | 43833001      |
|    | Hose PU12 Ø 63 L=20m   | 43833100      |
|    | Hose PU12 Ø 76 L=10m   | 43834200      |
|   | Hose PU12 Ø 76 L=20m   | 43834300      |
|  | Floor cleaning equipment width 500 mm with small nylon wheels        | 42932100***** |
|  | Floor cleaning equipment width 400 mm without wheels for dry suction | 42932800***** |
|  | Floor cleaning equipment width 400 mm with large rubber wheels       | 42932300***** |
|  | Floor nozzle, width 500 mm with small nylon wheels                   | 43840150***** |
|  | Floor nozzle, width 400 mm with large rubber wheels                  | 43840250***** |
|  | Floor nozzle width 400 mm without wheels for dry suction             | 43840550***** |
|  | Hand nozzle, hard brush Ø90 mm                                       | 43860001***** |
|   | Toothed nozzle width 130 mm  | 43861001***** |
|  | Cone nozzle Length 250 mm  | 43862001***** |
|  | Elbow pipe, Ø51 mm   | 43842150***** |
|  | Cleaning pipe, length 1100 mm, Ø51 mm                                | 43842001***** |
|  | Bulk nozzle for floor length 1200 mm                                 | 43850150***** |
|  | Bulk nozzle Length 910 mm  | 43850001***** |
|  | Scraper nozzle, length: 1000 mm                                      | 43851150***** |

## 600A, Configurable

|   | Accessory                                    | Part No       |
|---|--|---------------|
|    | Scraper nozzle, length: 500 mm               | 43851050***** |
|    | Steel swarf nozzle, Ø50 mm, Silenced inlet   | 40150030***** |
|    | Floor suction head width 500mm, Ø63          | 43840400***** |
|    | Bulk nozzle length 910 mm                    | 43850050***** |
|    | Bulk nozzle length 910 mm for swivel         | 43850051***** |
|    | Bulk nozzle for floor, length 1200 mm        | 43850200***** |
|    | Scraper hand nozzle, length 1000 mm          | 43851200***** |
|   | Suct pipe bend alum d63                      | 43843050***** |
|  | Swivel steel d63                             | 43843100***** |
|  | Suction pipe aluminium Ø63                   | 43843001***** |
|  | Scraper hand nozzle, length 500 mm           | 43851100***** |
|  | Bulk nozzle                                  | 43850100***** |
|  | Bulk nozzle with handle                      | 43850250***** |
|  | Scraper hand nozzle, length 1000 mm          | 43851250***** |
|  | Reducer conical d76-63, Acid stainless steel | 43880350      |
|  | Reducer conical d76-51, Acid stainless steel | 43880300      |
|  | Hose red conical d63-51                      | 43880250      |
|  | Hose connector d63                           | 43880100      |
|  | Hose connector d50                           | 43880050      |
|  | Bin Level Indicator (BLI) EX                 | 40375269      |
|  | Hose joint d76, Acid stainless steel         | 43880150      |
|  | Floor suct head d63/600                      | 43840450***** |

## 600A, Configurable

*\*Ø125mm Housing in NBR, Epoxy coated cast iron and flap/sleeve i stainless steel. Temp range -20C to +120C. Height - 110 mm (260 mm in open position)*

*\*\*Ø150mm Housing and flap in PA. Temp range -20C to +40C. Height - 155 mm (240 mm in open position)*

*\*\*\*Recommended with 43630100*

*\*\*\*\*Can be used with valves 43630300, 43632001, 43632100, 43630201*

*\*\*\*\*\*Couplings included, Ø 51 mm*

*\*\*\*\*\*ATEX - Suitable for combustible dust with MIE (minimum ignition energy) < 1mJ. Ensure earthing to extraction unit. Not to be used in combustible gas atmospheres or extraction of explosive materials*

*\*\*\*\*\*ATEX - This product is suitable to be used as cleaning equipment for combustible dusts with MIE (minimum ignition energy) >1 mJ. Product is to be properly earthed to the extraction unit. Not for usage in combustible gas atmospheres or extraction of xplosive materials.*

*\*\*\*\*\*ATEX - Suitable for combustible dust (zone 20,21,22) and gas (zone 1,2) of group IIA , IIB and IIC. Ensure earthing to extraction unit. Not to be used for extraction of explosive materials*



## 600A, Configurable

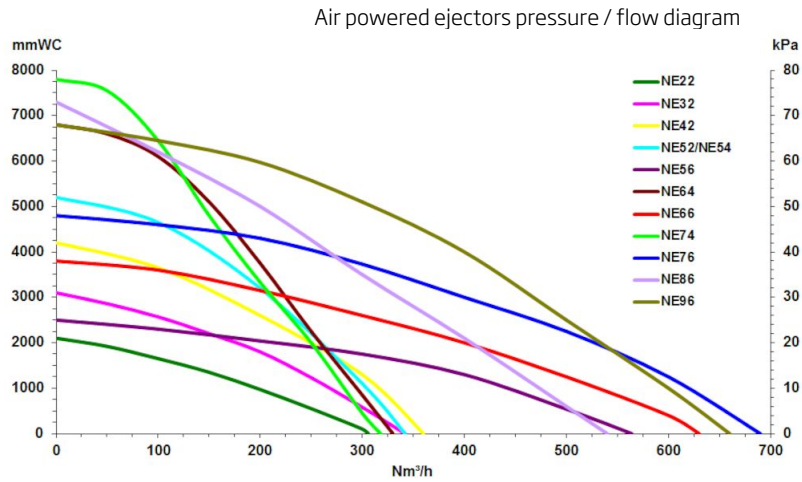

Air Powered ejectors

All performance data are based on 7 bar supply pressure

| Ejector/Hose dimension | ø51mm | ø63mm | ø76mm |
|------------------------|-------|-------|-------|
| NE64                   | 2     | 2,4   | N/A   |
| NE74                   | 2,3   | 2,7   | N/A   |
| NE76                   | 1,7   | 2,7   | 3,6   |
| NE96                   | 2,6   | 3,6   | 4,9   |

Capacity (tonne/hour) with Blasting media 2,4kg/liter and 20m hose

## 600A, Configurable

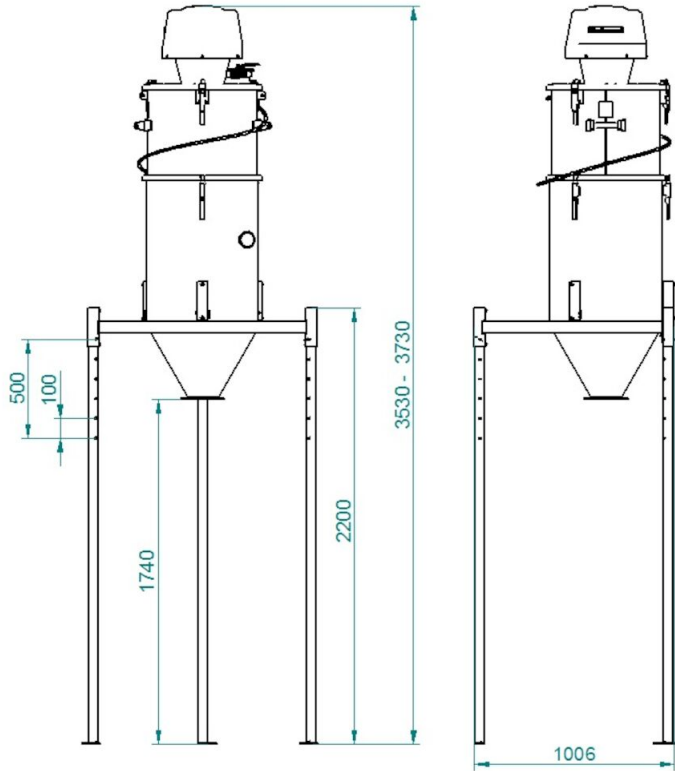

Dimensions with 2200 mm legs

## 600A, Configurable

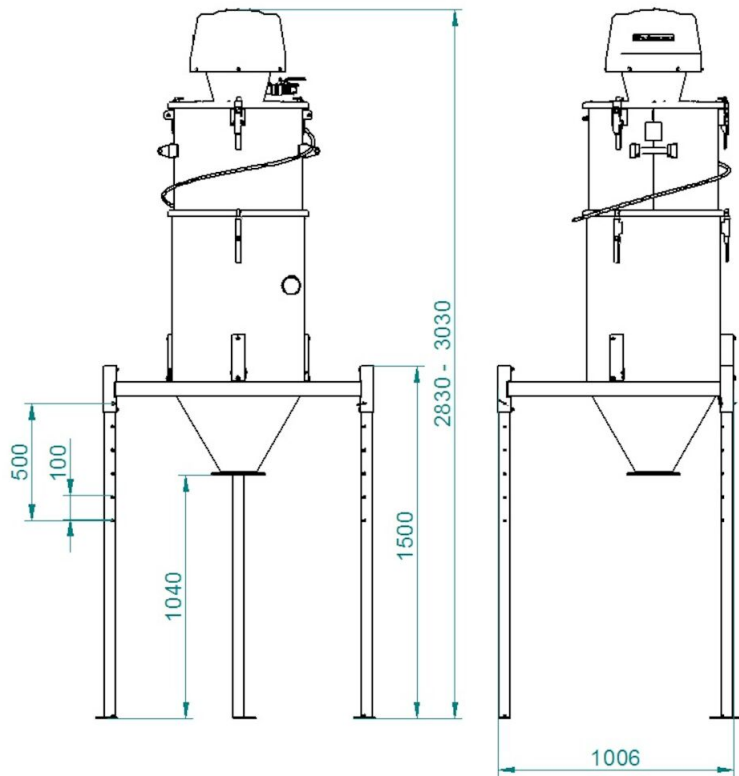

Dimensions with 1 500 mm legs