

Magna Stack

Exhaust extraction system for emergency vehicles with vertical stacks

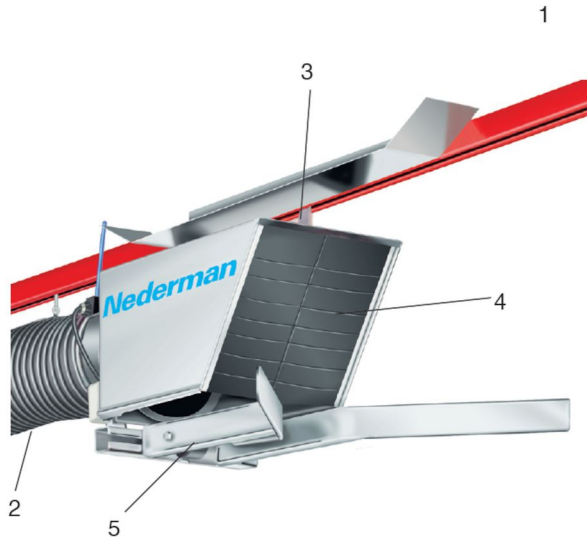

1. Track, 2. Exhaust hose, 3. Trolley, 4. Extraction hood, 5. Electro-magnet







MagnaStack is a fully automatic exhaust extraction system. The extraction unit designed as a hood enclosure automatically connects with the vertical exhaust stack as the vehicle is backed in to the parking bay. Guide arms position the laterally adjustable hood to the stack. The stack is locked to the hood with an electro-magnet. As the vehicle moves towards the exit, the horizontal hose and extraction hood follow smoothly along the guide track. At the doorway the electric power is automatically switched off, instantly releasing the electro-magnet and the exhaust stack from the hood.

- Capacity: 1 vehicle per system
- Exhaust pipes: vertical stacks
- Normal exit speed: up to 15 km/h, 10 mph
- For reverse-in vehicles
- Optional automatic start/stop device that offers:
 - Practical control of fan start/stop
 - Safe control of air quality (source ventilation automatically starts when vehicle engine starts)
 - Simple programming
 - Approval for radio equipment acc. to EC directives, FCC (USA) and IC (Canada)

Product name	Magna Stack
Protection class	IP 67
Installation	ในอาคาร
Diameter, hose (mm)	160



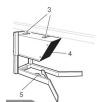

Magna Stack

פירוט	Description	Hose length (m)	Weight (kg)	קוד
	Emergency MagnaStack Horizontal unit	3	4,5 kg/m	20804263*
	Emergency MagnaStack Horizontal unit	6	4,5 kg/m	20804363*
	Emergency MagnaStack Horizontal unit	9	4,5 kg/m	20804463*
	Emergency MagnaStack Horizontal unit	9,8	4,5 kg/m	20812663*
	Emergency MagnaStack Horizontal unit	12	4,5 kg/m	20804563*
	Emergency MagnaStack Horizontal unit	15	4,5 kg/m	20804663*
	Emergency MagnaStack complete extraction hood		12	20805163
	Suspension device			20371306
	Suspension device. Without spring.			20371307

*Guide track with horizontal hose \varnothing 160 mm (6")

Magna Stack

อุปกรณ์เสริม		หมายเลขชิ้นส่วน
	Radio transmitter vehicle GHz	20376723
	Radio Receiver GHz	20376724
	Handheld radio transmitter GHz	20376725
	Program kit for radio system	20376726

Magna Stack

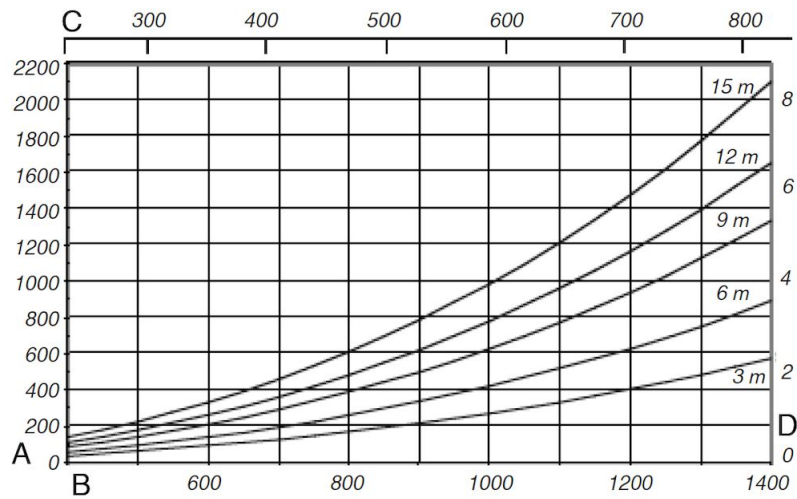

- A: Pressure drop (Pa)
- B: Airflow (m3/h)
- C: Airflow (cfm)
- D: Pressure drop (in w.g.)