

## NCF fans 50 Hz

---

















The Nederman NCF Fans have direct drive motors which means a safe and cost effective operation. Installing an energy efficient NCF fan with our other Nederman products saves time and reduces energy costs. It is a centrifugal fan designed for use in all types of industrial process and ventilation systems, mounted indoor as well as outdoor. The fan is equipped with vibration absorbers as standard.

---

Product name	NCF fans 50 Hz
Protection class	IP 55
Installation	Outdoor, Indoor
Material	Sheet metal, painted grey, RAL 7045
Ambient temperature range	-30 to +40 °C (22 F to 104 F)
Operating Temperature	Max. 60 °C
Frequency (Hz)	50
No of phases	3



## NCF fans 50 Hz

Image	Description	Power Voltage (V)	Amperage (A)	Noise level (dB(A))	Weight (kg)	Power (kW)	Model
	FAN NCF120/15	230/400	24,0/13,8	85 db(A) at 10000 m <sup>3</sup> /h	123	7,5	14550228
	FAN NCF30/15	230/400	7,9 / 4,6	69 db(A) at 2500 m <sup>3</sup> /h	67	2,2	14550128
	FAN NCF30/25	230/400	13,6/7,8	74 db(A) at 4000 m <sup>3</sup> /h	105	4	14550328
	FAN NCF40/25	230/400	17,9/10,3	75 db(A) at 4000 m <sup>3</sup> /h	110	5,5	14550428
	FAN NCF50/25	230/400	17,9/10,3	78 db(A) at 3500 m <sup>3</sup> /h	112	5,5	14550528
	FAN NCF80/20	230/400	24,0/13,8	77 db(A) at 6000 m <sup>3</sup> /h	150	7,5	14550628
	FAN NCF120/25	230/400	46,1/26,5	82 db(A) at 8000 m <sup>3</sup> /h	232	15	14550728
	FAN NCF160/25	230/400	56,5/32,5	84 db(A) at 10000 m <sup>3</sup> /h	292	18,5	14550828
	FAN NCF120/15	400/690	13,8/8,0	85 db(A) at 10000 m <sup>3</sup> /h	123	7,5	14550928
	FAN NCF30/25	400/690	7,8/4,5	74 db(A) at 4000 m <sup>3</sup> /h	105	4	14551028
	FAN NCF40/25	400/690	10,3/6,0	75 db(A) at 4000 m <sup>3</sup> /h	110	5,5	14551128
	FAN NCF50/25	400/690	10,3/6,0	78 db(A) at 3500 m <sup>3</sup> /h	112	5,5	14551228
	FAN NCF80/20	400/690	13,8/8,0	77 db(A) at 6000 m <sup>3</sup> /h	150	7,5	14551328
	FAN NCF120/25	400/690	26,5/15,3	82 db(A) at 8000 m <sup>3</sup> /h	232	15	14551428
	FAN NCF160/25	400/690	32,5/18,8	84 db(A) at 10000 m <sup>3</sup> /h	292	18,5	14551528

## NCF fans 50 Hz

	Accessory	Part No
	Inlet adap. d250,30/15,40/25,50/25	14374438
	Inlet adapter d315, 30/25	14374439
	Inlet adapter d400, 80/20, 120/25	14374440
	Inlet adapter d500, 120/15, 160/25	14374441
	Outl. adap.288x205 d315,30/15,40/25	14374442
	Outlet adapter 322x229 d400, 30/25	14374443
	Outl.adap.361x256 d400,80/20,120/25	14374444
	Outl.adap.453x322d500,120/15,160/25	14374445
	Outl.adap.256x183 d250, 50/25,30/20	14374446
	Flex.inl.ad..d250,30/15,40/25,50/25	14374447
	Flexible inlet adapter d315, 30/25	14374448
	Flex.inlet.adap.d400, 80/20, 120/25	14374449
	Flex.inlet.adap.d500,120/15,160/25	14374450
	Flex.out.a.288x205 d315,30/15,40/25	14374451
	Flex.outlet adap.322x229 d400,30/25	14374452
	Flex.out.a.361x256d400,80/20,120/25	14374453
	Flex.ou.a.453x322d500,120/15,160/25	14374454
	Flex.ou.a.256x183 d250, 50/25,30/20	14374455
	Inl.guardnet d250,30/15,40/25,50/25	14374456
	Inlet guard net d315, 30/25	14374457
	Inlet guard net d400, 80/20, 120/25	14374458
	Inlet guard net d500,120/15,160/25	14374459

## NCF fans 50 Hz

	Accessory	Part No
	Outlet guard net, 30/15, 40/25	14374460
	Outlet guard net, 30/25	14374461
	Outlet guard net, 80/20, 120/25	14374462
	Outlet guard net, 120/15, 160/25	14374463
	Outlet guard net, 50/25	14374464
	Vibration absorber AM 40, 1 set	14374624
	Vibration absorber AM 30, 1 set	14374628
	Vibration absorber AM 25, 1 set	14374629
	Vibration absorber AM 50, 1 set	14374630
	Inlet adapter d250, 30/20	14375076
	Fan starter 5.5kW (2,2 - 5,5 kW motor power)	14514837
	Fan starter 11kW (4,0 - 11,0 kW motor power)	14514937
	Fan starter 18.5kW (15,0 - 18,5 kW motor power)	14515037
	Fan starter 22kW (18,5 - 22,0 kW motor power)	14515537
	Fan Inverter for 5,5 kW motor power	14522037*
	Fan Inverter for 7,5 kW motor power	14522137**
	Fan Inverter for 11 kW motor power	14522237**
	Fan Inverter for 15 kW motor power	14522637**
	Fan Inverter for 18,5 kW motor power	14525137**
	Fan Inverter for 22 kW motor power	14525237**

\*Pressure sensor 2000 Pa

\*\*Pressure sensor 5000 Pa

## NCF fans 50 Hz

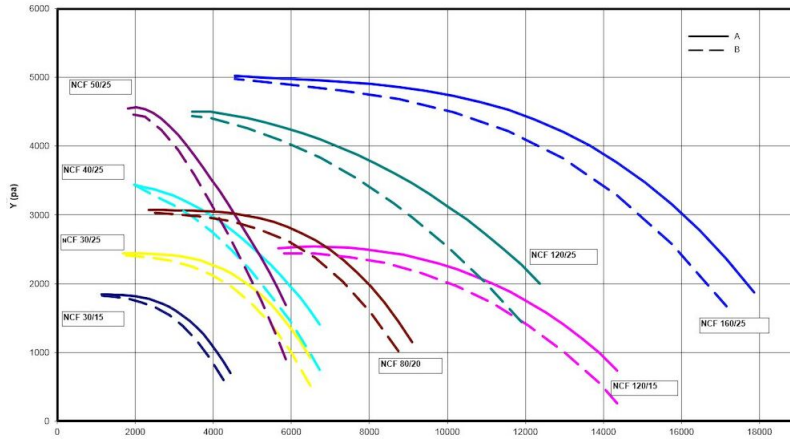

Y = Pressure drop

X = Air flow

A = Total pressure

B = Static pressure

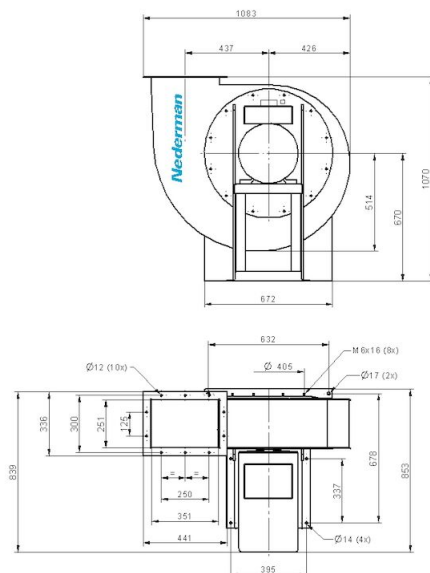

Fan NCF 120/25

Duct inlet diameter 400 mm

Duct outlet diameter 400 mm

## NCF fans 50 Hz

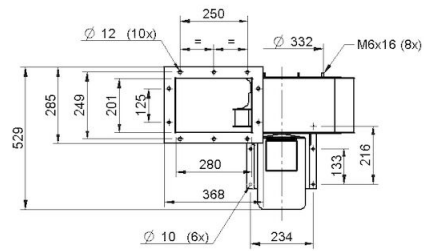
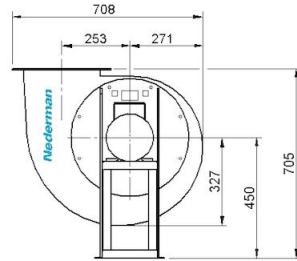

NCF 30/15

Duct inlet diameter 250 mm

Duct outlet diameter 315 mm

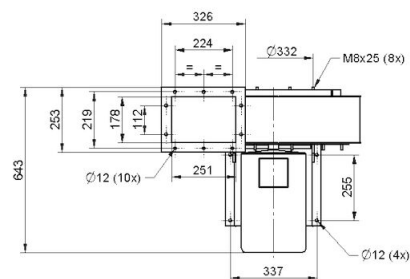
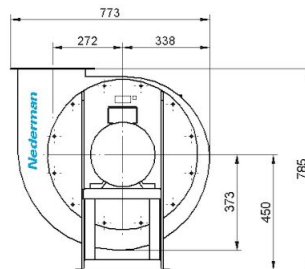

NCF 50/25

Duct inlet diameter 250 mm

Duct outlet diameter 250 mm

## NCF fans 50 Hz

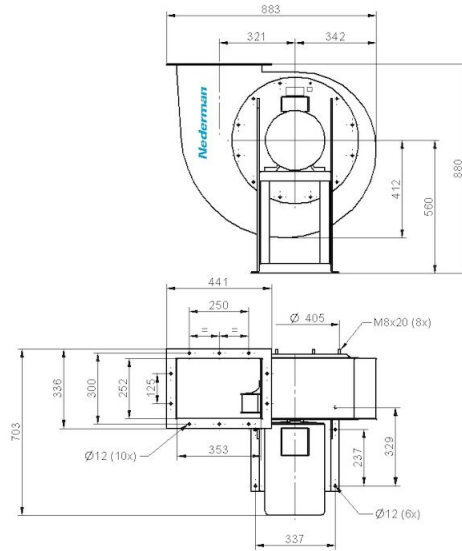

NCF 80/20

Duct inlet diameter 400 mm

Duct outlet diameter 400 mm

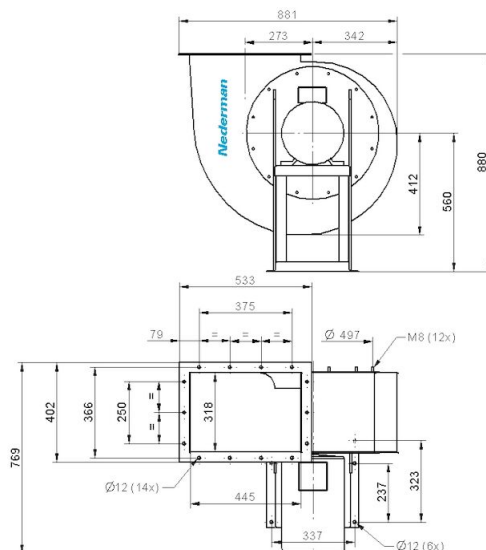

NCF 120/15

Duct inlet diameter 500 mm

Duct outlet diameter 500 mm

## NCF fans 50 Hz

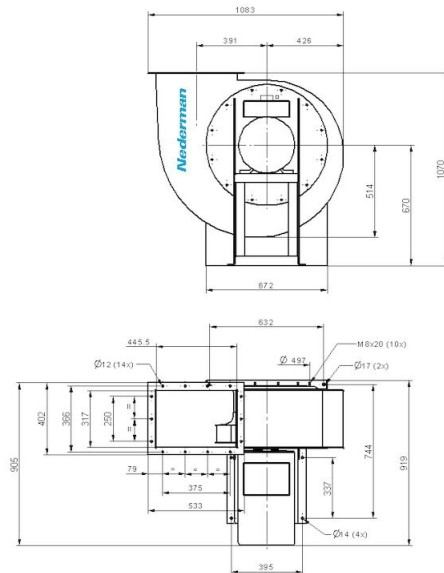

NCF 160/25

Duct inlet diameter 500 mm

Duct outlet diameter 500 mm

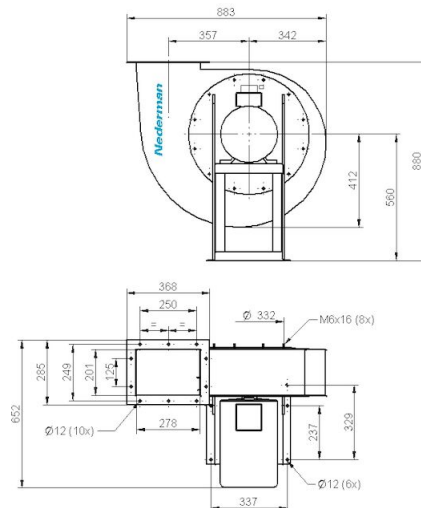

NCF 40/25

Duct inlet diameter 250 mm

Duct outlet diameter 315 mm



## NCF fans 50 Hz

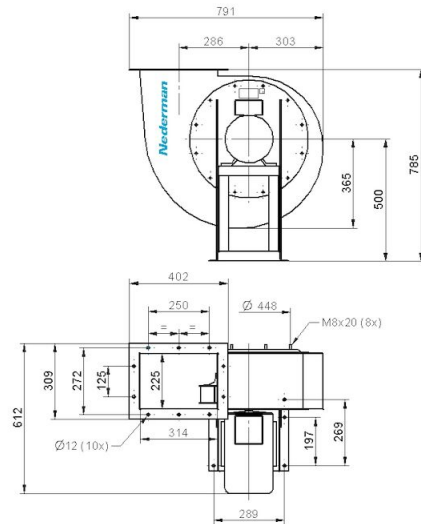

NCF 30/25

Duct inlet diameter 315 mm

Duct outlet diameter 400 mm