

NCF-ventilatoren

Nederman NCF-ventilatoren: veilig, energiezuinig en duurzaam voor optimale luchtcirculatie.



Nederman NCF-ventilatoren bieden een hoogwaardige oplossing voor industriële luchtverplaatsing met direct aangedreven motoren. Deze efficiënte ventilatoren zijn niet alleen veilig in gebruik, maar dragen ook bij aan aanzienlijke kostenbesparingen op het gebied van energie. Door een NCF-ventilator te integreren met andere Nederman-producten, kunt u niet alleen uw operationele efficiëntie verhogen, maar ook uw energieverbruik optimaliseren.















Deze veelzijdige centrifugaalventilator is geschikt voor een breed scala aan industriële processen en ventilatietoepassingen, zowel voor binnen- als buitengebruik. Of u nu werkt in een productiefaciliteit, een werkplaats of een ander industrieel setting, de NCF-ventilator levert betrouwbare prestaties om te voldoen aan uw luchtcirculatiebehoeften.

Een ander voordeel van de NCF-ventilatoren is de ingebouwde trillingsdemping, die zorgt voor een soepele en stille werking. Dit draagt niet alleen bij aan het comfort van uw werkomgeving, maar verlengt ook de levensduur van de ventilator en vermindert onderhoudskosten.

Product naam	NCF-ventilatoren
Beschermingsklasse	IP 55
Installatie	Buiten, Binnen
Materiaal	Plaatmetaal, grijs gelakt, Ral 7045
Omgevingstemperatuur	-30 to +40 °C (22 F to 104 F)
Temperatuurbereik	Max. 60 °C
Frequentie (Hz)	50
Aantal fase	3



NCF-ventilatoren

Afbeelding	Naam voor Datasheet	Voltage (V)	Amperage (A)	Geluidsniveau (dB(A))	Gewicht (kg)	Vermogen (kW)	Model
	FAN NCF120/15	230/400	24,0/13,8	85 db(A) bij 10000 m ³ /h	123	7,5	14550228
	FAN NCF30/15	230/400	7,9 / 4,6	69 db(A) bij 2500 m ³ /h	67	2,2	14550128
	FAN NCF30/25	230/400	13,6/7,8	74 db(A) bij 4000 m ³ /h	105	4	14550328
	FAN NCF40/25	230/400	17,9/10,3	75 db(A) bij 4000 m ³ /h	110	5,5	14550428
	FAN NCF50/25	230/400	17,9/10,3	78 db(A) bij 3500 m ³ /h	112	5,5	14550528
	FAN NCF80/20	230/400	24,0/13,8	77 db(A) bij 6000 m ³ /h	150	7,5	14550628
	FAN NCF120/25	230/400	46,1/26,5	82 db(A) bij 8000 m ³ /h	232	15	14550728
	FAN NCF160/25	230/400	56,5/32,5	84 db(A) bij 10000 m ³ /h	292	18,5	14550828
	FAN NCF120/15	400/690	13,8/8,0	85 db(A) bij 10000 m ³ /h	123	7,5	14550928
	FAN NCF30/25	400/690	7,8/4,5	74 db(A) bij 4000 m ³ /h	105	4	14551028
	FAN NCF40/25	400/690	10,3/6,0	75 db(A) bij 4000 m ³ /h	110	5,5	14551128
	FAN NCF50/25	400/690	10,3/6,0	78 db(A) bij 3500 m ³ /h	112	5,5	14551228
	FAN NCF80/20	400/690	13,8/8,0	77 db(A) bij 6000 m ³ /h	150	7,5	14551328
	FAN NCF120/25	400/690	26,5/15,3	82 db(A) bij 8000 m ³ /h	232	15	14551428
	FAN NCF160/25	400/690	32,5/18,8	84 db(A) bij 10000 m ³ /h	292	18,5	14551528

NCF-ventilatoren

Toebehoren		Artikelnummer
	Inlet adap. d250,30/15,40/25,50/25	14374438
	Inlet adapter d315, 30/25	14374439
	Inlet adapter d400, 80/20, 120/25	14374440
	Inlet adapter d500, 120/15, 160/25	14374441
	Outl. adap.288x205 d315,30/15,40/25	14374442
	Outlet adapter 322x229 d400, 30/25	14374443
	Outl.adap.361x256 d400,80/20,120/25	14374444
	Outl.adap.453x322d500,120/15,160/25	14374445
	Outl.adap.256x183 d250, 50/25,30/20	14374446
	Flex.inl.ad..d250,30/15,40/25,50/25	14374447
	Flexible inlet adapter d315, 30/25	14374448
	Flex.inlet.adap.d400, 80/20, 120/25	14374449
	Flex.inlet.adap.d500,120/15,160/25	14374450
	Flex.out.a.288x205 d315,30/15,40/25	14374451
	Flex.outlet adap.322x229 d400,30/25	14374452
	Flex.out.a.361x256d400,80/20,120/25	14374453
	Flex.ou.a.453x322d500,120/15,160/25	14374454
	Flex.ou.a.256x183 d250, 50/25,30/20	14374455
	Inl.guardnet d250,30/15,40/25,50/25	14374456
	Inlet guard net d315, 30/25	14374457
	Inlet guard net d400, 80/20, 120/25	14374458
	Inlet guard net d500,120/15,160/25	14374459

NCF-ventilatoren

Toebehoren		Artikelnummer
	Outlet guard net, 30/15, 40/25	14374460
	Outlet guard net, 30/25	14374461
	Outlet guard net, 80/20, 120/25	14374462
	Outlet guard net, 120/15, 160/25	14374463
	Outlet guard net, 50/25	14374464
	Vibration absorber AM 40, 1 set	14374624
	Vibration absorber AM 30, 1 set	14374628
	Vibration absorber AM 25, 1 set	14374629
	Vibration absorber AM 50, 1 set	14374630
	Inlet adapter d250, 30/20	14375076
	Fan starter 5.5kW (2,2 - 5,5 kW motor power)	14514837
	Fan starter 11kW (4,0 - 11,0 kW motor power)	14514937
	Fan starter 18.5kW (15,0 - 18,5 kW motor power)	14515037
	Fan starter 22kW (18,5 - 22,0 kW motor power)	14515537
	Fan Inverter for 5,5 kW motor power	14522037*
	Fan Inverter for 7,5 kW motor power	14522137**
	Fan Inverter for 11 kW motor power	14522237**
	Fan Inverter for 15 kW motor power	14522637**
	Fan Inverter for 18,5 kW motor power	14525137**
	Fan Inverter for 22 kW motor power	14525237**

*Pressure sensor 2000 Pa

**Pressure sensor 5000 Pa

NCF-ventilatoren

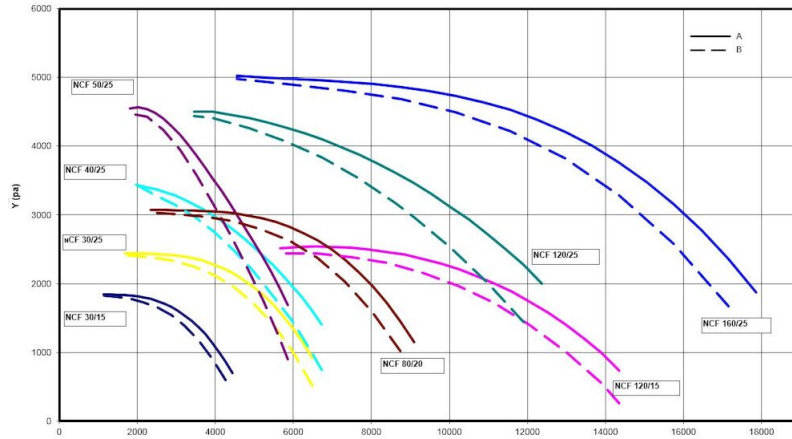

Y = Pressure drop

X = Air flow

A = Total pressure

B = Static pressure

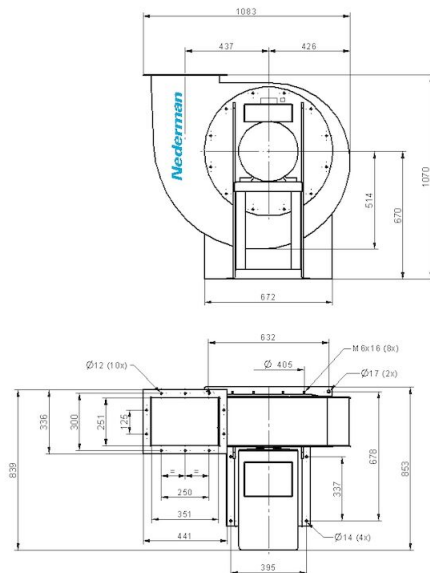

Fan NCF 120/25

Duct inlet diameter 400 mm

Duct outlet diameter 400 mm

NCF-ventilatoren

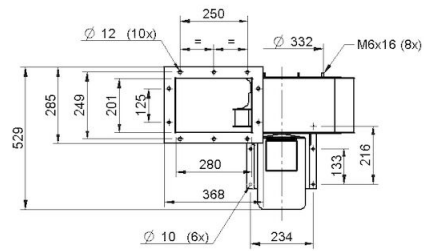
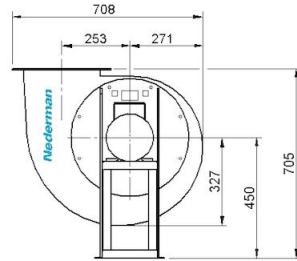

NCF 30/15

Duct inlet diameter 250 mm

Duct outlet diameter 315 mm

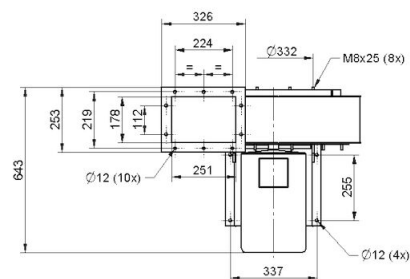
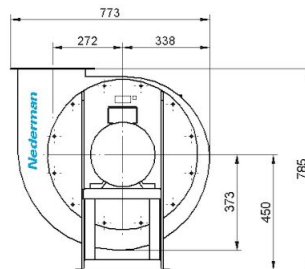

NCF 50/25

Duct inlet diameter 250 mm

Duct outlet diameter 250 mm

NCF-ventilatoren

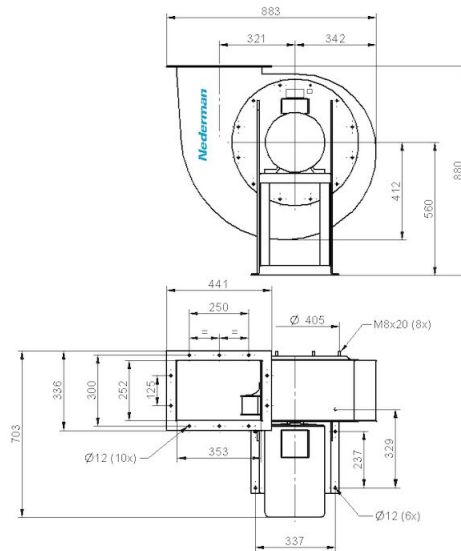

NCF 80/20

Duct inlet diameter 400 mm

Duct outlet diameter 400 mm

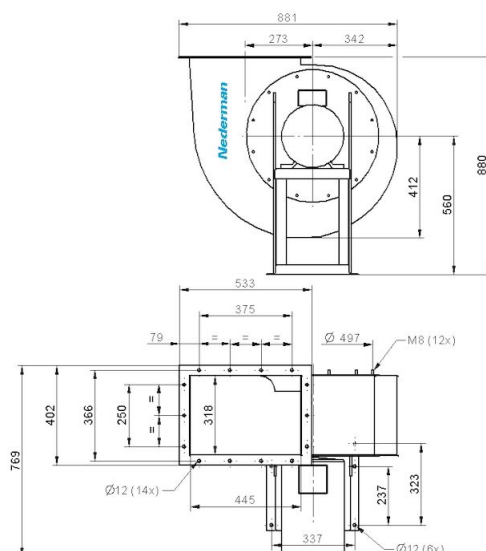

NCF 120/15

Duct inlet diameter 500 mm

Duct outlet diameter 500 mm

NCF-ventilatoren

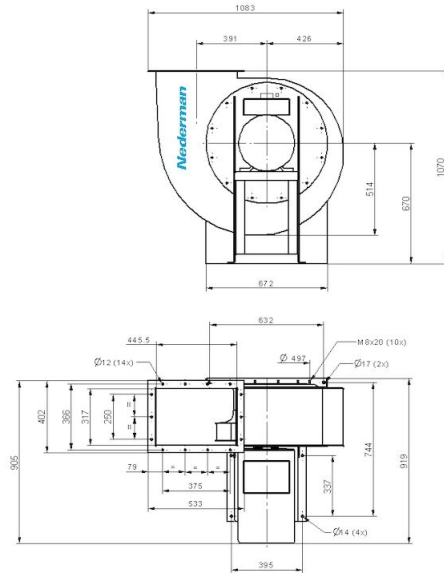

NCF 160/25

Duct inlet diameter 500 mm

Duct outlet diameter 500 mm

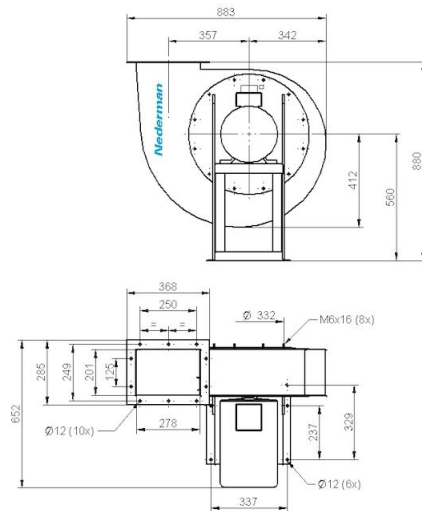

NCF 40/25

Duct inlet diameter 250 mm

Duct outlet diameter 315 mm

NCF-ventilatoren

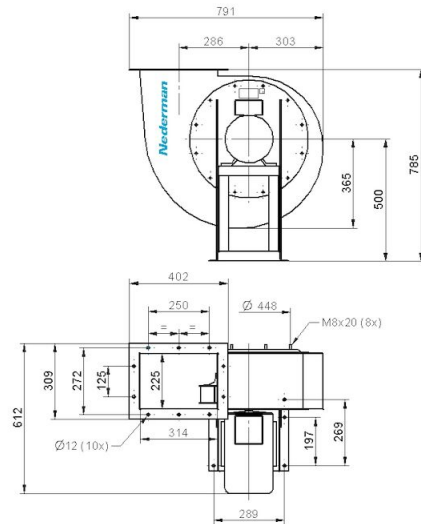

NCF 30/25

Duct inlet diameter 315 mm

Duct outlet diameter 400 mm