















Redukcja QF

Redukcje dla kanałów QF







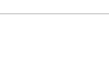









Nazwa produktu	Redukcja QF
Połączenie	QF















Redukcja QF

Zdjęcie	średnica 1 (mm)	Grubość (mm)	Średnica 2 (mm)	Model
	100	0,9	80	8240000309
	125	0,9	80	8240000310
	125	0,9	100	8240000311
	140	0,9	80	8240000312
	140	0,9	100	8240000313
	140	0,9	125	8240000314
	150	0,9	80	8240000315
	150	0,9	100	8240000316
	150	0,9	125	8240000317
	150	0,9	140	8240000318
	160	0,9	80	8240000319
	160	0,9	100	8240000320
	160	0,9	125	8240000321
	160	0,9	140	8240000322
	160	0,9	150	8240000323















Redukcja QF

Zdjęcie	średnica (1) (mm)	Grubość (mm)	Średnica 2 (mm)	Model
	180	0,9	80	8240000324
	180	0,9	100	8240000325
	180	0,9	125	8240000326
	180	0,9	140	8240000327
	180	0,9	150	8240000328
	180	0,9	160	8240000329
	200	0,9	80	8240000330
	200	0,9	100	8240000331
	200	0,9	125	8240000332
	200	0,9	140	8240000333
	200	0,9	150	8240000334
	200	0,9	160	8240000335
	200	0,9	180	8240000336
	224	0,9	100	8240000338
	224	0,9	125	8240000339















Redukcja QF

Zdjęcie	średnica 1 (mm)	Grubość (mm)	Średnica 2 (mm)	Model
	224	0,9	140	8240000340
	224	0,9	150	8240000341
	224	0,9	160	8240000342
	224	0,9	180	8240000343
	224	0,9	200	8240000344
	250	0,9	80	8240000345
	250	0,9	100	8240000346
	250	0,9	125	8240000347
	250	0,9	140	8240000348
	250	0,9	150	8240000349
	250	0,9	160	8240000350
	250	0,9	180	8240000351
	250	0,9	200	8240000352
	250	0,9	224	8240000353
	300	0,9	140	8240000357















Redukcja QF

Zdjęcie	średnica (1) (mm)	Grubość (mm)	Średnica 2 (mm)	Model
	300	0,9	150	8240000358
	300	0,9	160	8240000359
	300	0,9	180	8240000360
	300	0,9	200	8240000361
	300	0,9	224	8240000362
	300	0,9	250	8240000363
	315	0,9	100	8240000364
	315	0,9	125	8240000365
	315	0,9	140	8240000366
	315	0,9	150	8240000367
	315	0,9	160	8240000368
	315	0,9	180	8240000369
	315	0,9	200	8240000370
	315	0,9	224	8240000371
	315	0,9	250	8240000372















Redukcja QF

Zdjęcie	średnica 1 (mm)	Grubość (mm)	Średnica 2 (mm)	Model
	315	0,9	300	8240000373
	350	0,9	125	8240000374
	350	0,9	140	8240000375
	350	0,9	160	8240000377
	350	0,9	180	8240000378
	350	0,9	200	8240000379
	350	0,9	224	8240000380
	350	0,9	250	8240000381
	350	0,9	300	8240000382
	350	0,9	315	8240000383
	400	0,9	140	8240000384
	400	0,9	160	8240000386
	400	0,9	180	8240000387
	400	0,9	200	8240000388
	400	0,9	224	8240000389















Redukcja QF

Zdjęcie	średnica (1) (mm)	Grubość (mm)	Średnica 2 (mm)	Model
	400	0,9	250	8240000390
	400	0,9	300	8240000391
	400	0,9	315	8240000392
	400	0,9	350	8240000393
	450	0,9	160	8240000395
	450	0,9	180	8240000396
	450	0,9	200	8240000397
	450	0,9	224	8240000398
	450	0,9	250	8240000399
	450	0,9	300	8240000400
	450	0,9	315	8240000401
	450	0,9	350	8240000402
	450	0,9	400	8240000403
	500	0,9	160	8240000404
	500	0,9	180	8240000405

Redukcja QF

Zdjęcie	średnica 1 (mm)	Grubość (mm)	Średnica 2 (mm)	Model
	500	0,9	200	8240000406
	500	0,9	224	8240000407
	500	0,9	250	8240000408
	500	0,9	300	8240000409
	500	0,9	315	8240000410
	500	0,9	350	8240000411
	500	0,9	400	8240000412
	500	0,9	450	8240000413
	560	0,9	250	8240000417
	560	0,9	300	8240000418
	560	0,9	315	8240000419
	560	0,9	350	8240000420
	560	0,9	400	8240000421
	560	0,9	450	8240000422
	560	0,9	500	8240000423

Redukcja QF

Zdjęcie	średnica (1) (mm)	Grubość (mm)	Średnica 2 (mm)	Model
	630	0,9	300	8240000427
	630	0,9	315	8240000428
	630	0,9	350	8240000429
	630	0,9	400	8240000430
	630	0,9	450	8240000431
	630	0,9	500	8240000432
	630	0,9	560	8240000433
	710	0,9	315	8240000437
	710	0,9	350	8240000438
	710	0,9	400	8240000439
	710	0,9	450	8240000440
	710	0,9	500	8240000441
	710	0,9	560	8240000442
	710	0,9	630	8240000443
	315		80	8240009305

Redukcja QF

Zdjęcie	średnica (1) (mm)	Grubość (mm)	Średnica 2 (mm)	Model
		0,7	80	8240009306
	400	0,9	80	8240009308
	400	0,9	100	8240009309
	400	0,9	125	8240009310
	450	0,9	80	8240009311
	450	0,9	100	8240009312
	450	0,9	140	8240009314
	630	0,9	160	8240009331

Redukcja QF

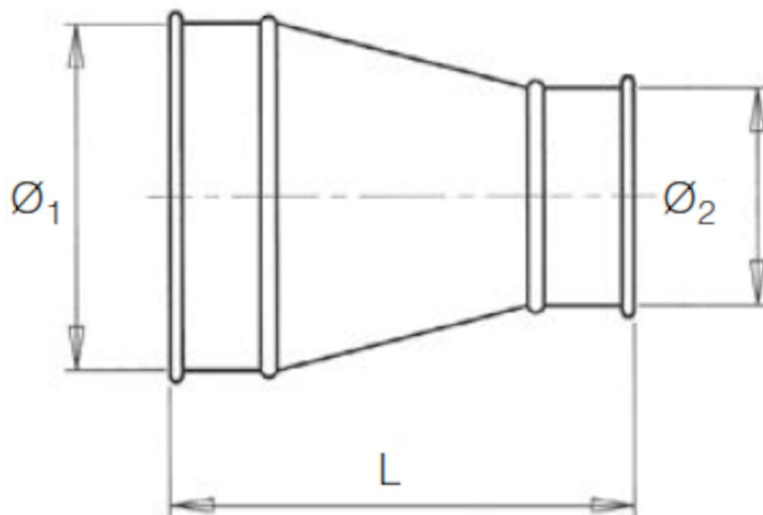

$$L = (\varnothing_1 - \varnothing_2) + 165\text{mm}$$