

## QFS adapters and accessories

Adapters and various accessories for QFS (Quick Fit Sealed) ducting systems

---



---

Produktnavn	QFS adapters and accessories
-------------	------------------------------

# QFS adapters and accessories

Bilde	Navn på datablad	Diameter (mm)	Length (m)	Vekt (kg)	Thickness (mm)	Model
		80		0,09	0,7	8210001050
		100		0,13	0,7	8210001051
		125		0,18	0,7	8210001052
		140		0,22	0,7	8210001053
		150		0,24	0,7	8210001054
		160		0,26	0,7	8210001055
		180		0,35	0,7	8210001056
		200		0,4	0,7	8210001057
		224		0,49	0,7	8210001058
		250		0,62	0,7	8210001059
		300		0,88	0,7	8210001060
		315		1,15	0,7	8210001061
		350		1,6	0,7	8210001062
		400		2,12	0,9	8210001063
		80				8210000125















## QFS adapters and accessories

Bilde	Navn på datablad	Diameter (mm)	Length (m)	Vekt (kg)	Thickness (mm)	Model
		100				8210000126
		125				8210000127
		140				8210000128
		150				8210000129
		160				8210000130
		180				8210000131
		200				8210000132
		224				8210000133
		250				8210000134
		300				8210000135
		315				8210000136
		350				8210000137
		400				8210000138
						8210000038
						8210000039









## QFS adapters and accessories

Bilde	Navn på datablad	Diameter (mm)	Length (m)	Vekt (kg)	Thickness (mm)	Model
						8210000040
						8210000041
						8210000042
						8210000043
						8210000044
						8210000045
						8210000046
						8210000047
						8210000048
		100	185	6		8210000805*
		150		7		8210000806*
		160	385	7		8210003389*
		200	185	9		8210000807*
		250	185	10		8210000808*
		300	185	10		8210000809*

## QFS adapters and accessories

Bilde	Navn på datablad	Diameter (mm)	Length (m)	Vekt (kg)	Thickness (mm)	Model
		350	485	11,5		8210000810*
		400	485	11,5		8210000811*
		100	185	7,5		8210000798**
		150		8,5		8210000799**
		160	385	8,5		8210003390**
		200	185	10,5		8210000800**
		250	185	11,5		8210000801**
	LCP 11-44 For dry dust	300	185	11,5		8210000802**
		350	485	13		8210000803**
		400	485	13		8210000804**
		80			0,9	8210001134
		100			0,9	8210001135
		125			0,9	8210001136
		140			0,9	8210001137
		150			0,9	8210001138

## QFS adapters and accessories

Bilde	Navn på datablad	Diameter (mm)	Length (m)	Vekt (kg)	Thickness (mm)	Model
		160			0,9	8210001139
		180			0,9	8210001140
		200			0,9	8210001141
		224			0,9	8210001142
		250			0,9	8210001143
		300			0,9	8210001144
		315			0,9	8210001145
		350			0,9	8210001146
		400			0,9	8210001147

\*Manual Damper

\*\*Automatic Damper

# QFS adapters and accessories

QF Machine adapter dimensions

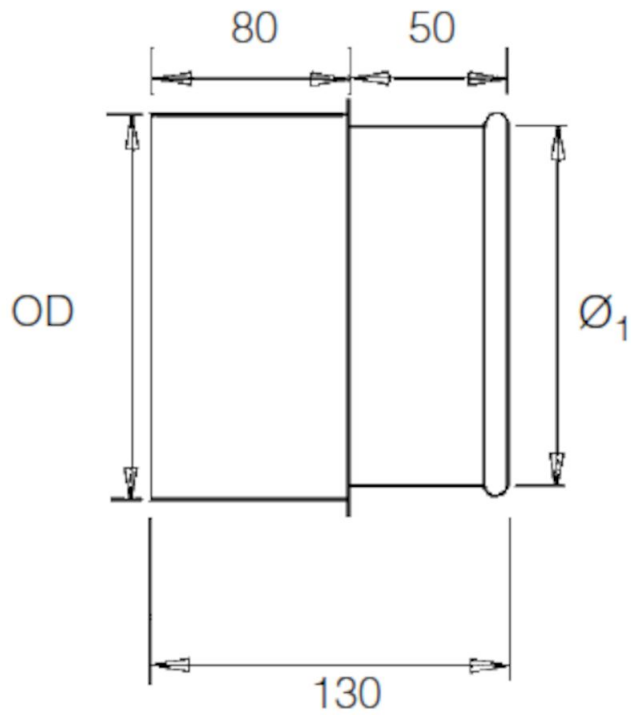

QF Machine adapter dimensions

# QFS adapters and accessories

QF Ventilation adapter

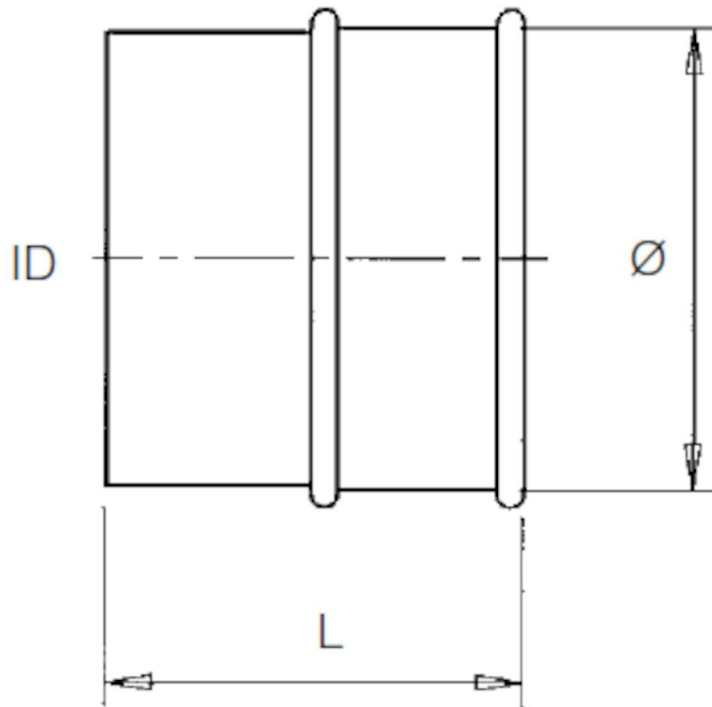

QF Ventilation adapter



## QFS adapters and accessories

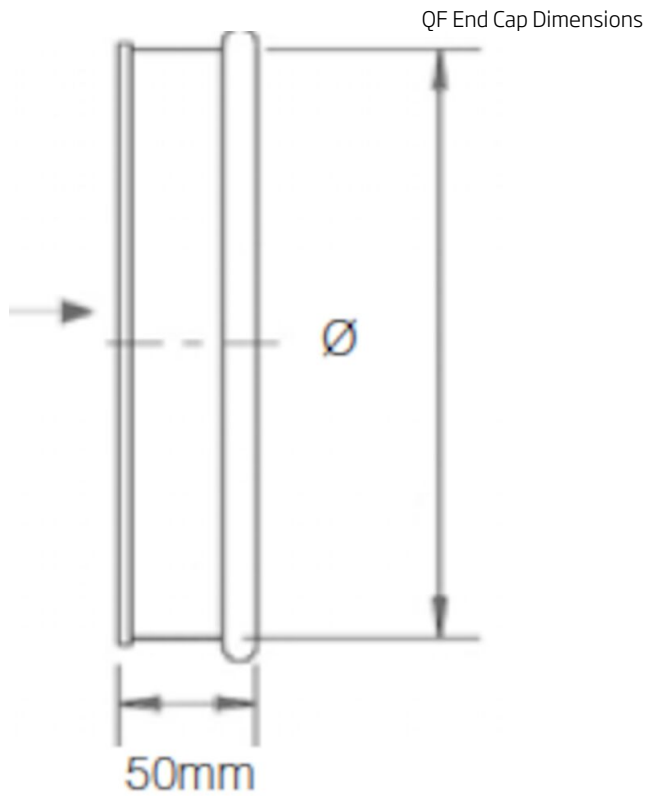

QF End Cap Dimensions, 22012-XXX

