

OMF 3x4000 SM

FibreDrain® oil mist collector for continuous operation.



Nederman FibreDrain® OMF oil mist collectors are designed to handle large amounts of emulsion mist during continuous operation. They are developed with focus on high efficient filtration together with low maintenance cost.



Nederman FibreDrain® OMF 3x4000 has as standard 3 filter-stages where the first stage consists of filter cassettes with Nederman's FibreDrain® technology. Nederman have a wide range of different types of filters to suit many different kind of applications. The second stage consists of a HEPA filter in filter class H13 with an efficiency of 99,95% for MPPS according to EN1822. All tower built Nederman FibreDrain® OMF units are prepared for use of pre filter. OMF 3x4000 have a top mounted radial fan.

- Three filter stages, optional pre-filter
- Gauges for reading of pressure drop over each filter stage
- Drain: 4 off 1 1/2"
- Non-vibration fan suspension system

Наименование товара	OMF 3x4000 SM
Стандарт	2009/125/EC
Объем (для перевозки) (м³)	17.9
Уровень шума (дБ(А))	<70 dB(A) @1,5 m from service side with optional fan enclosure and silencer
Класс защиты	IP55
Эффективность фильтрации (%)	99,95
Установка	Снаружи помещения
Материал	Sheet metal, painted both in- and outside.
Метод очистки фильтра	[Draining]
Рабочее давление (кПа)	Max 4600 Pa
Производительность (макс. воздушный поток м3/час)	12000
Рабочая температура	60 deg C (limited by filter)
Напряжение (В)	400/690
Частота (Гц)	50
Количество фаз	3
Количество фильтроэлементов	18
Сила тока (А)	26 / 15,1
Цвет	NCS-S 1005 B20G
Вес (кг)	1925
Мощность (кВт)	15
Пояснение к техническим данным	Plus 6 optional filter elements.















OMF 3x4000 SM

[image]	Название листа технических данных	[model]
	OMF 3x4000, Inlet flange 560x560mm left. Drain 4 x 1 1/2" Female.	12401153*
	OMF 3x4000, Inlet flange 560x560mm right. Drain 4 x 1 1/2" Female.	12401154*

*Plus 6 optional filter elements.

OMF 3x4000 SM

	[accessory]	[partno]
	Drain pump box, 50 Hz, 10 litre/min at 5m, including controller	12400054*
	Drain container with piping	12400764**
	Optional FibreDrain Pre Filter ORF 610x610x96 mm.	12400039
	FibreDrain Filter 1 OMF; 600x600x292 mm	12400009
	FibreDrain Filter 2 OMF; 600x600x292 mm	12400010
	HEPA Filter H13; 610x610x292 mm	12400012
	Inlet adapter OSF 4x3000, OMF 3x4000, OMF 2x6000	12401163
	Extension structure OSF 3x2000, OMF 3x4000	12401165
	Fan enclosure 2 filters in depth	12401109
	Silencer 90° Ø 630 mm	12401159
	Drain pump box, 50 Hz, 10 litre/min at 10m, including controller	12401330
	OSF/OMF Instruction manual for mounting system for electric components	12401342
	OMF/OSF/MQL mounting system for electrical components	12401341

*Drain connection must be elevated min 200 mm from pump box support level

**Drain connection must be elevated min 420mm from container support level

OMF 3x4000 SM

OMF 3x4000 with inlet from left side:

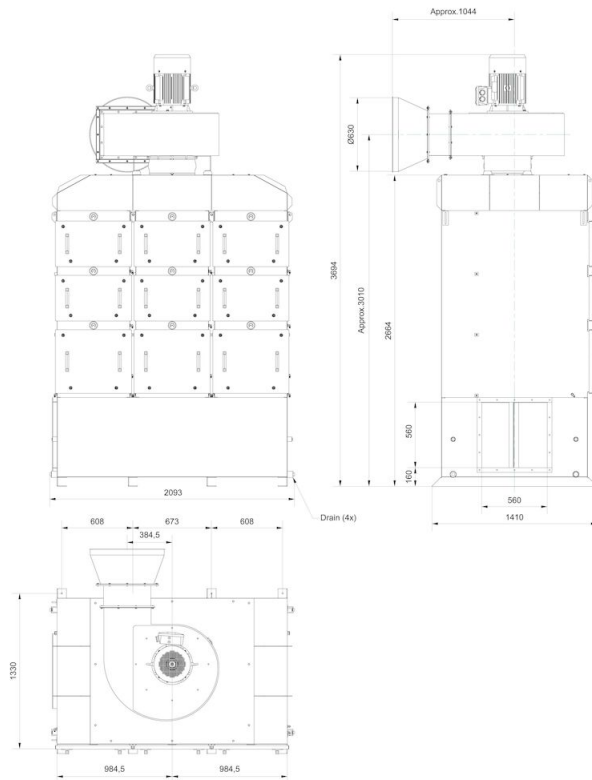

OMF 3x4000 SM

OMF 3x4000 complete with options:



OMF 3x4000 SM

OMF 3x4000 assembly of options:



OMF 3x4000 SM

Dimension Inlet Adapter OSF4x3000_OMF3x4000_2x6000,
accessory 12401163:

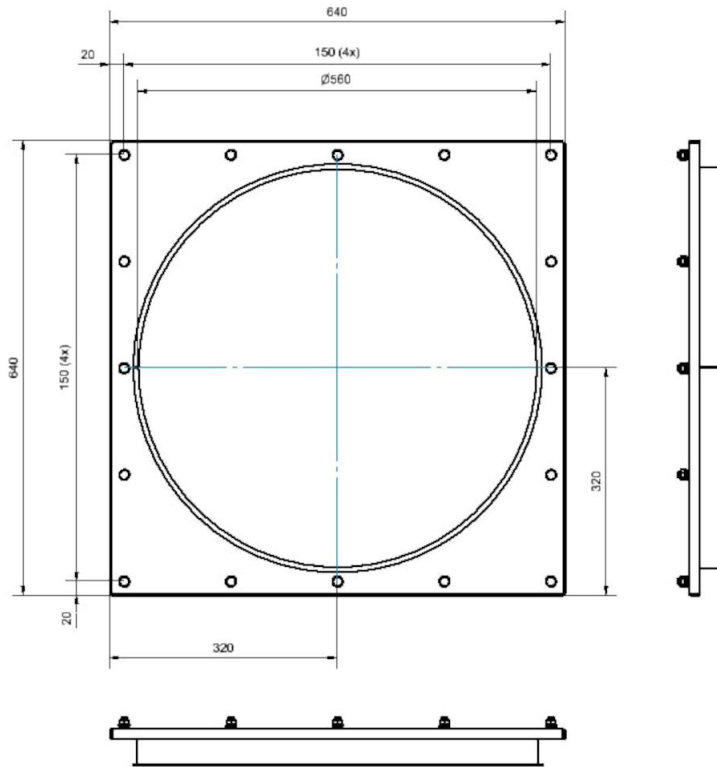

Dimension Extension Structure OSF3x2000_OMF3x4000,
accessory 12401165:

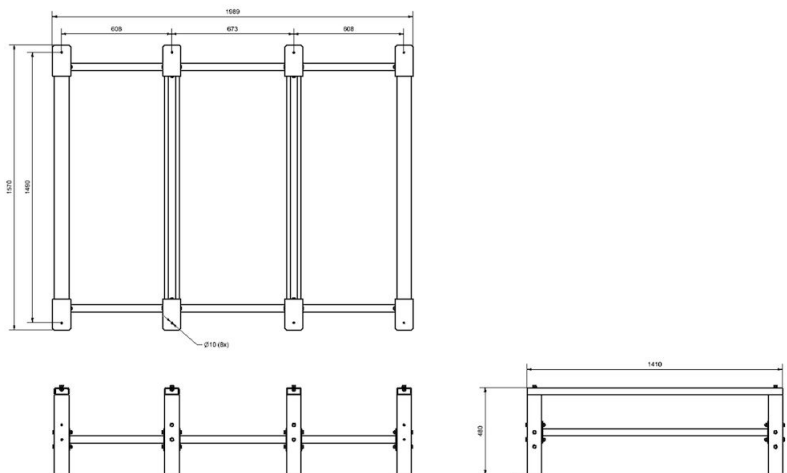

OMF 3x4000 SM

Dimension Fan Enclosure_OSF2x2000_3x2000_4x2000_5x200_OMF2x4000_4x4000,
accessory 12401109:

