

OMF 2x6000 SM

FibreDrain® olietågefilter (emulsion) for kontinuerlig drift.



Nederman OMF olietåge eliminator er designet til at håndtere store mængder af emulsionståge under kontinuerlig drift. De er udviklet med fokus på høj effektivitet og lave vedligeholdelsesomkostninger.

Nederman OMF 2x6000 har som standard tre filter trin, hvor de første to trin består af filterkassetter med Nederman FibreDrain® teknologi. Nederman har flere forskellige typer af filter til forskellige typer af applikationer. Det tredje trin består af et HEPA filter i i filterklasse H13 med en effektivitet på 99,95% for MPPS iht. EN1822. Alle Nederman OMF enheder er forberedt for brug af forfilter.

- Tre filter trin, forudskiller som option
- Målere til registrering af trykfald over hvert filter trin
- Drain: 4 off 1 1/2"
- Non-vibration fan suspension system

Produkt navn	OMF 2x6000 SM
Standarder	2009/125/EC
Volumen (for fragt m ³)	15,4
Lydniveau (dB(A))	< 70 dB(A) @1,5 m from service side with optional fan enclosure and silencer
Beskyttelsesklasse	IP55
Filter udskilningsgrad (%)	99,95
Installation	Indendørs
Materiale	Metalplade, malet både ind- og udvendigt
Metode for filterrensning	[Draining]
Arbejdstryk (kPa)	Max 4600 Pa
Kapacitet (max luftvolumen m ³ /h)	12000
Driftstemperatur	60°C (begrænset af filter)
Spænding (V)	400/690
Frekvens (Hz)	50
Faser	3
Antal filter	18
Strøm (A)	26 / 15,1
Farve	NCS-S 1005 B20G
Vægt (kg)	1810
Effekt (kW)	15
Afklaring af tekniske data	Plus seks filter element som option.











OMF 2x6000 SM

Billede	Beskrivelse	Model
	OMF 2x6000, Indløbsflange 560x560mm venstre. Dræn 4 x 1 ½" Hun.	12401155*
	OMF 2x6000, Indløbsflange 560x560mm højre. Dræn 4 x 1 ½" Hun.	12401156*

**Plus seks filter element som option.*

OMF 2x6000 SM

Tilbehør		Artikelnummer
	Drain pump box, 50 Hz, 10 litre/min at 5m, including controller	12400054*
	Drain container with piping	12400764**
	Optional FibreDrain Pre Filter ORF 610x610x96 mm.	12400039
	FibreDrain Filter 1 OMF; 600x600x292 mm	12400009
	FibreDrain Filter 2 OMF; 600x600x292 mm	12400010
	HEPA Filter H13; 610x610x292 mm	12400012
	Inlet adapter OSF 4x3000, OMF 3x4000, OMF 2x6000	12401163
	Extension structure OMF 2x6000	12401169
	Fan enclosure 3 filters in depth	12401160
	Silencer 90° Ø 630 mm	12401159
	Drain pump box, 50 Hz, 10 litre/min at 10m, including controller	12401330
	OSF/OMF Instruction manual for mounting system for electric components	12401342
	OMF/OSF/MQL mounting system for electrical components	12401341

*Drain connection must be elevated min 200 mm from pump box support level

**Drain connection must be elevated min 420mm from container support level

OMF 2x6000 SM

OMF 2x6000 assembly of options:



OMF 2x6000 SM

OMF 2x6000 complete with options:



OMF 2x6000 SM

OMF 2x6000 with inlet from left side:

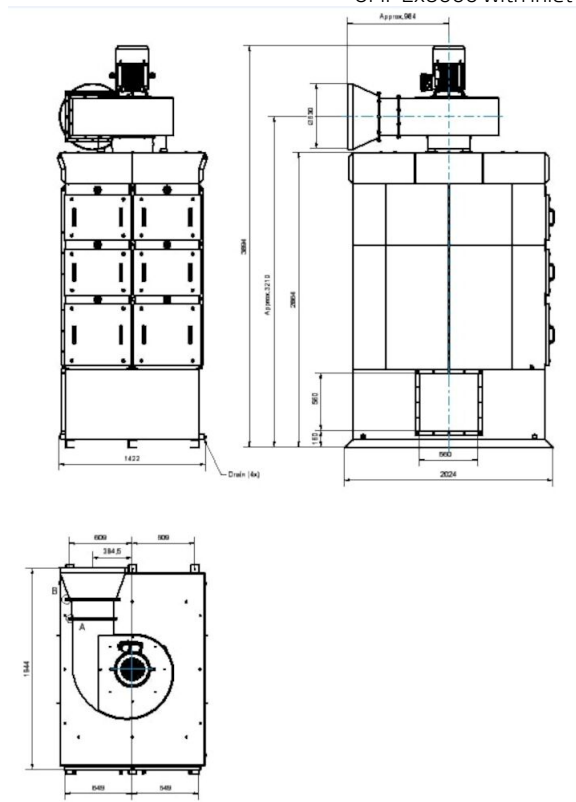

OMF 2x6000 SM

OMF 2x6000 with inlet from right side:

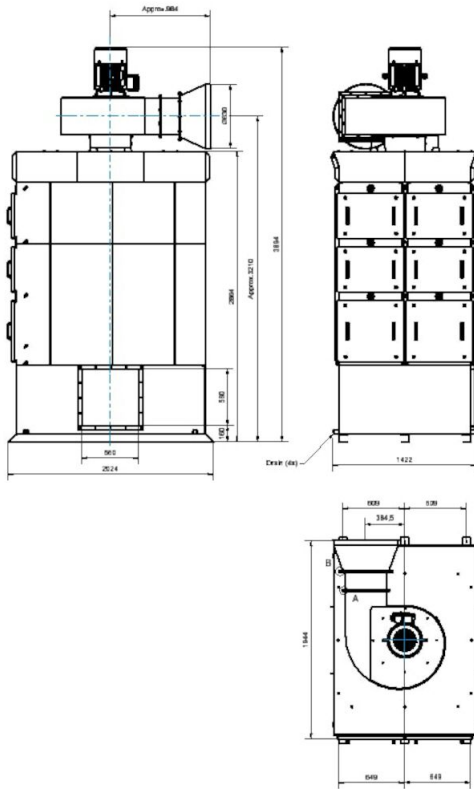

OMF 2x6000 SM

Dimension Inlet Adapter OSF4x3000_OMF3x4000_2x6000,
accessory 12401163:

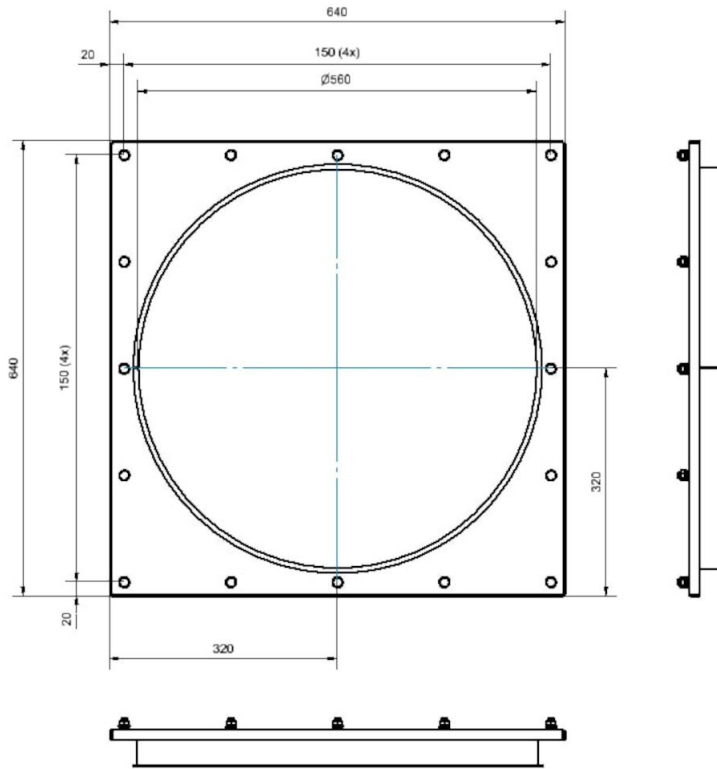

OMF 2x6000 SM

Dimension Extensions Structure OMF2x6000,
accessory 12401169:

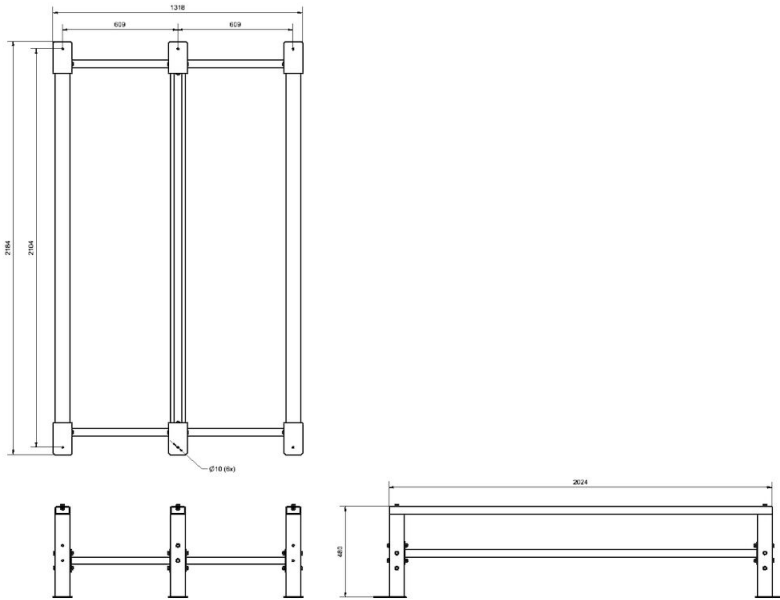

Dimension Fan Enclosure OSF4x3000_OMF2x6000,
accessory 12401160:

