

OMF 2x6000 SM

FibreDrain® oil mist collector for continuous operation.



Nederman OMF oil mist eliminators are designed to handle large amounts of emulsion mist during continuous operation. They are developed with focus on high efficient filtration together with low maintenance cost.



Nederman OMF 2x6000 has as standard 3 filter-stages where the first 2 stages consists of filter cassettes with Nederman Nederman's FibreDrain® technology. Nederman have a wide range of different types of filters to suit many different kind of applications. The third stage consists of a HEPA filter in filter class H13 with an efficiency of 99,95% for MPPS according to EN1822. All tower built Nederman OMF units are prepared for use of pre filter. OMF 2x6000 have a top mounted radial fan.

- Three filter stages, optional pre-filter
- Gauges for reading of pressure drop over each filter stage
- Drain: 4 off 1 1/2"
- Non-vibration fan suspension system

Product name	OMF 2x6000 SM
Standard	2009/125/EC
Volume (for shipping) (m³)	15.4
Noise level (dB(A))	< 70 dB(A) @1,5 m from service side with optional fan enclosure and silencer
Protection class	IP55
Filter efficiency (%)	99,95
Installation	[Indoor]
Material	Sheet metal, painted both in- and outside.
Filter cleaning method	Self-Draining
Working pressure (kPa)	Max 4600 Pa
Capacity (max airflow m³/h)	12000
Operating Temperature	60 deg C (limited by filter)
Power Voltage (V)	400/690
Frequency (Hz)	50
No of phases	3
Number of filter elements	18
Amperage (A)	26 / 15,1
Colour	NCS-S 1005 B20G
Weight (kg)	1810
Power (kW)	15
Note	Plus 6 optional filter elements.













OMF 2x6000 SM

Image	Description	Model
	OMF 2x6000, Inlet flange 560x560mm left. Drain 4 x 1 1/2" Female.	12401155*
	OMF 2x6000, Inlet flange 560x560mm right. Drain 4 x 1 1/2" Female.	12401156*

*Plus 6 optional filter elements.

OMF 2x6000 SM

	Accessory	Part No
	Drain pump box, 50 Hz	12400054*
	Drain container with piping	12400764**
	Optional FibreDrain Pre Filter ORF 610x610x96 mm.	12400039
	FibreDrain Filter 1 OMF; 600x600x292 mm	12400009
	FibreDrain Filter 2 OMF; 600x600x292 mm	12400010
	HEPA Filter H13; 610x610x292 mm	12400012
	Inlet adapter OSF 4x3000, OMF 3x4000, OMF 2x6000	12401163
	Extension structure OMF 2x6000	12401169
	Fan enclosure 3 filters in depth	12401160
	Silencer 90° Ø 630 mm	12401159
	Drain pump box, 50 Hz, 10 litre/min at 10m, including controller	12401330

*Drain connection must be elevated min 200 mm from pump box support level

**Drain connection must be elevated min 420mm from container support level

OMF 2x6000 SM

OMF 2x6000 assembly of options:



OMF 2x6000 SM

OMF 2x6000 complete with options:



OMF 2x6000 SM

OMF 2x6000 with inlet from left side:

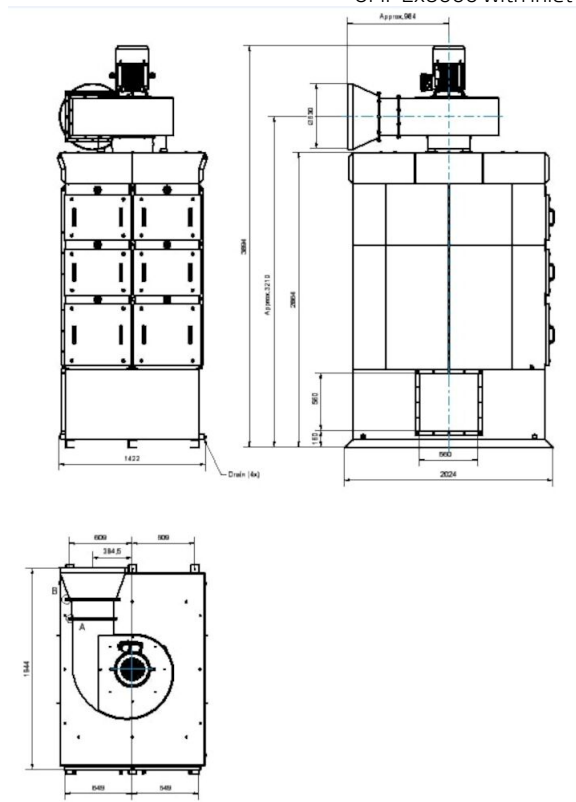

OMF 2x6000 SM

OMF 2x6000 with inlet from right side:

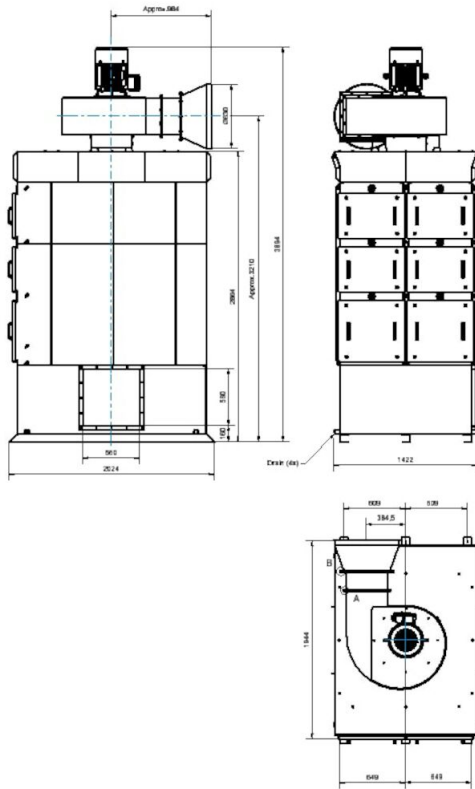

OMF 2x6000 SM

Dimension Inlet Adapter OSF4x3000_OMF3x4000_2x6000,
accessory 12401163:

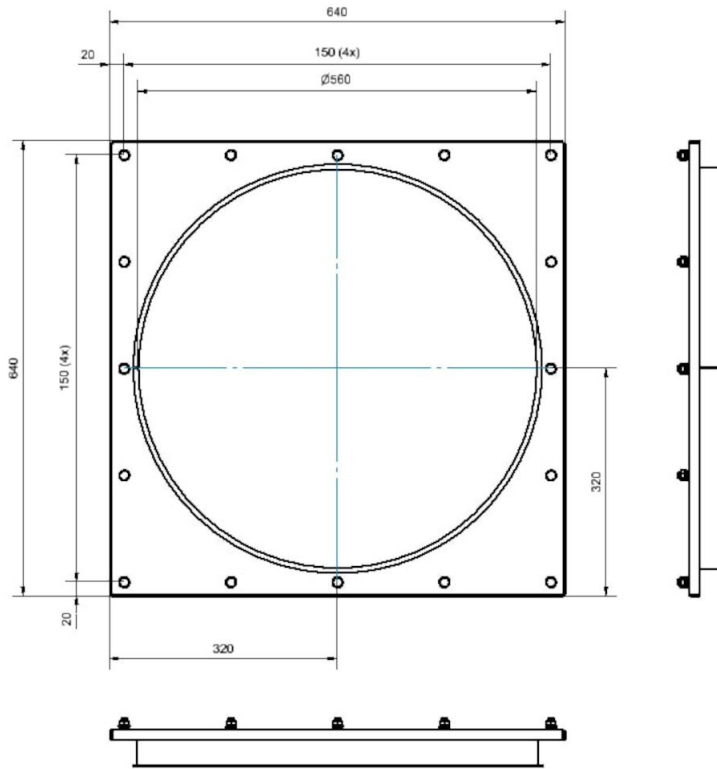

OMF 2x6000 SM

Dimension Extensions Structure OMF2x6000,
accessory 12401169:

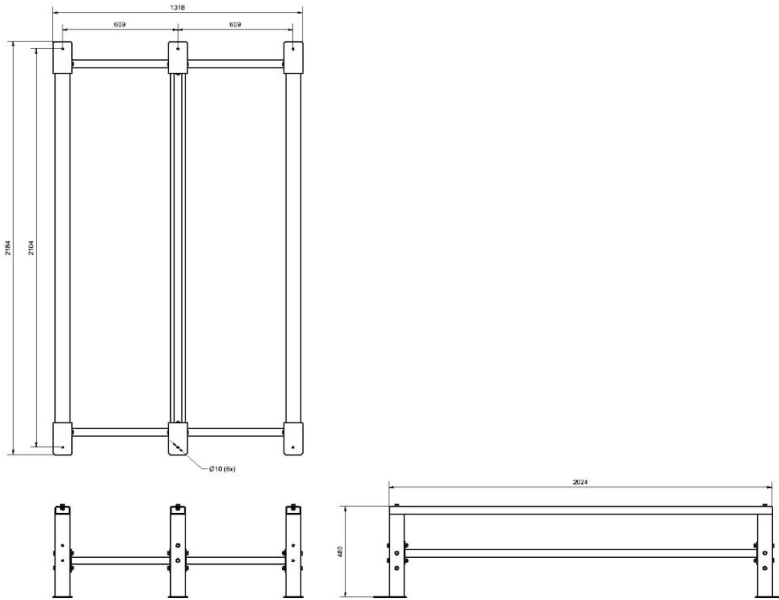

Dimension Fan Enclosure OSF4x3000_OMF2x6000,
accessory 12401160:

