

## OMF 2x6000 SM

FibreDrain® oljetåke oppsamler for kontinuerlig drift.



Nederman OMF oljetåkeliminertor er utformet for å håndtere store mengder damp under kontinuerlig drift. De er utviklet med fokus på høyeffektiv filtrering med lave vedlikeholdskostnader.



Nederman OMF 2x6000 har som standard tre filternivåer der de to første nivåene består av filterkassetter med Nedermans FibreDrain®-teknologi. Nederman har et bredt spekter av ulike typer filtre for mange ulike typer programmer. Det tredje nivået består av et HEPA-filte i filterklassen H13 med en virkningsgrad på 99,95 % for MPPS iht. EN1822. Alle Nederman OMF-enhetene er klargjort for bruk av pre-filteet.

- Tre filternivåer, valgfritt forfilter
- Målere for lesing av trykkfall ved hvert filtertrinn
- Drain: 4 off 1 1/2"
- Non-vibration fan suspension system

|   |  |
|---|--|
| Produktnavn                                   | OMF 2x6000 SM  |
| Standard                                      | 2009/125/EC  |
| Volum (for frakt) (m <sup>3</sup> )           | 15.4   |
| Støynivå (dB(A))                              | < 70 dB(A) @1,5 m fra serviceside med ekstra lyddempet viftehus og lyddemper |
| Beskyttelsesklasse:                           | IP55   |
| Filtereffektivitet (%)                        | 99,95  |
| Installasjon                                  | Innendørs  |
| Materiale                                     | Metallplater malt både innvendig og utvendig                                 |
| Rengjøringsmetode, filter                     | Automatisk filter rens   |
| Arbeidstrykk (kPa)                            | Max 4600 Pa  |
| Kapasitet (maks. luftstrøm m <sup>3</sup> /t) | 12000  |
| Driftstemperatur                              | 60°C (begrænset af filter)   |
| Spenning (V)                                  | 400/690  |
| Frekvens Hz                                   | 50   |
| Antall faser                                  | 3  |
| Antall filterelementer                        | 18   |
| Strømstyrke (A)                               | 26 / 15,1  |
| Farge   | NCS-S 1005 B20G  |
| Vekt (kg)                                     | 1810   |
| Kraft (kW)                                    | 15   |
| Avklaring av teknisk informasjon              | Plus seks filter element som option  |















## OMF 2x6000 SM

| Bilde   | Navn på datablad  | Model     |
|---|---|-----------|
|  | OMF 2x6000, Innløpsflens 560x560mm venstre. Utløp 4 x 1 ½" Hun. | 12401155* |
|  | OMF 2x6000, Innløpsflens 560x560mm høyre. Utløp 4 x 1 ½" Hun.   | 12401156* |

*\*Plus seks filter element som option*

## OMF 2x6000 SM

| Tilbehør  |  | Artikkelnummer |
|---|--|----------------|
|    | Avløpspumpeboks, 50 Hz   | 12400054*      |
|    | Drain container with piping  | 12400764**     |
|    | Forfilter ORF 610x610x96   | 12400039       |
|    | Filter 1 emulsjon (OMF2000,4000,6000)                                  | 12400009       |
|    | Filter 2 emulsjon (OMF2000,4000,6000))                                 | 12400010       |
|    | HEPA-filter  | 12400012       |
|    | Inlet adapter OSF 4x3000, OMF 3x4000, OMF 2x6000                       | 12401163       |
|   | Extension structure OMF 2x6000   | 12401169       |
|  | Fan enclosure 3 filters in depth                                       | 12401160       |
|  | Silencer 90° Ø 630 mm  | 12401159       |
|  | Drain pump box, 50 Hz, 10 litre/min at 10m, including controller       | 12401330       |
|  | OSF/OMF Instruction manual for mounting system for electric components | 12401342       |
|  | OMF/OSF/MQL mounting system for electrical components                  | 12401341       |

\*Drain connection must be elevated min 200 mm from pump box support level

\*\*Drain connection must be elevated min 420mm from container support level

## OMF 2x6000 SM

OMF 2x6000 assembly of options:



# OMF 2x6000 SM

OMF 2x6000 complete with options:



## OMF 2x6000 SM

OMF 2x6000 with inlet from left side:

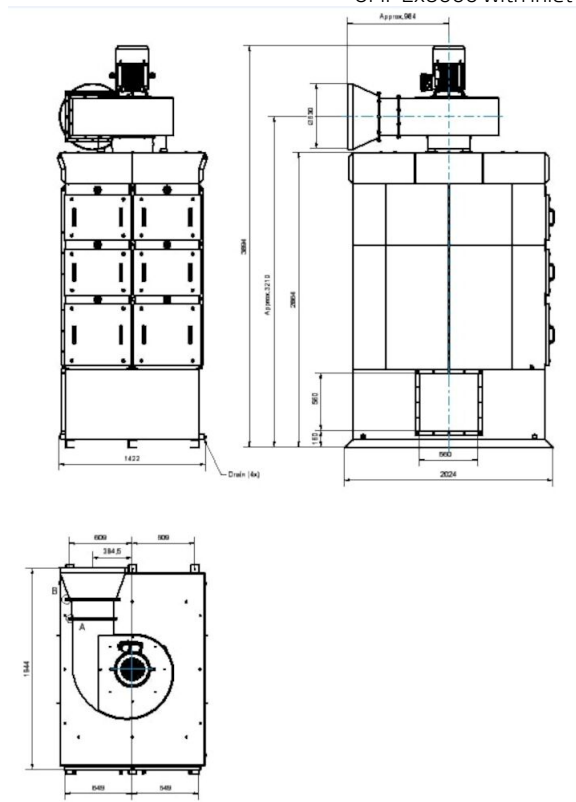

## OMF 2x6000 SM

OMF 2x6000 with inlet from right side:

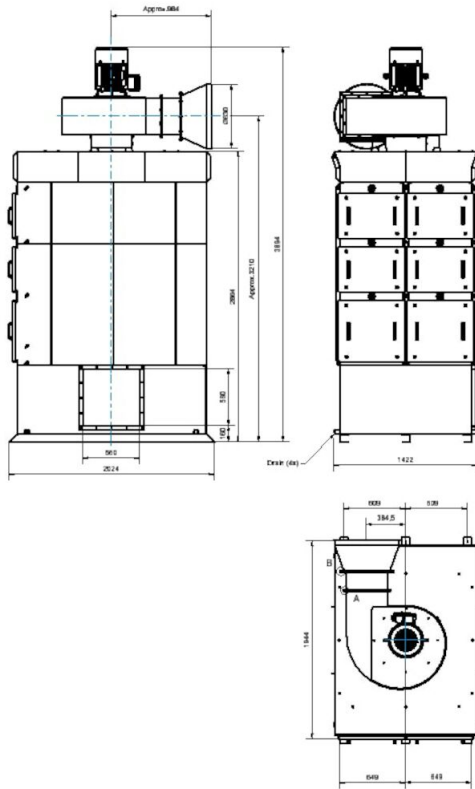

## OMF 2x6000 SM

Dimension Inlet Adapter OSF4x3000\_OMF3x4000\_2x6000,  
accessory 12401163:

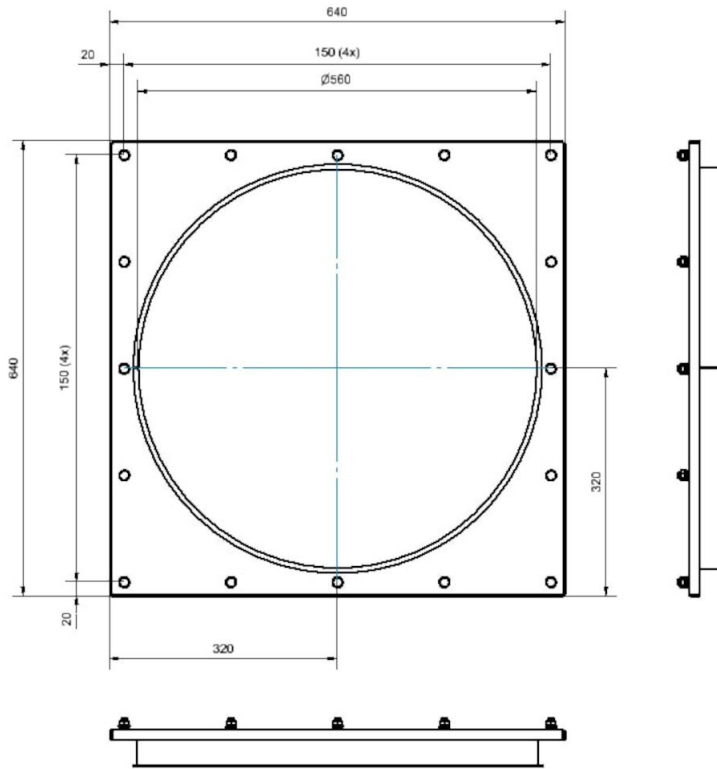



## OMF 2x6000 SM

Dimension Extensions Structure OMF2x6000,  
accessory 12401169:

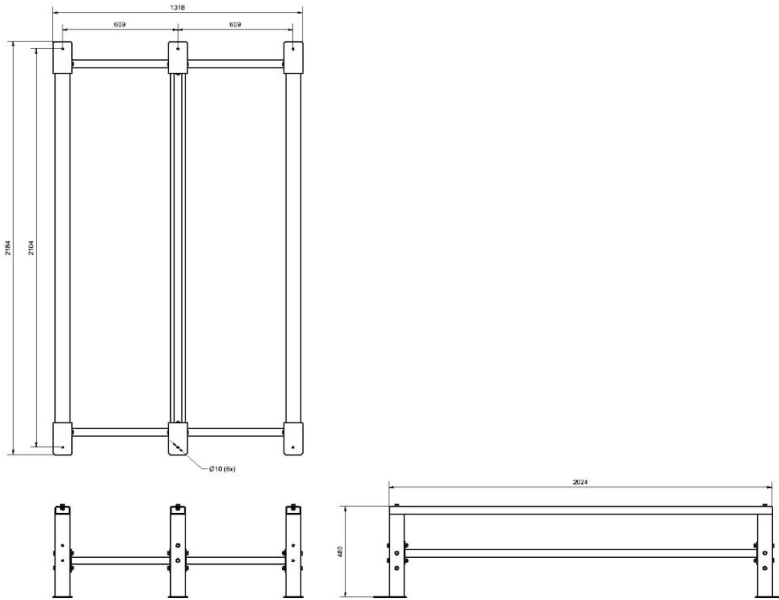

Dimension Fan Enclosure OSF4x3000\_OMF2x6000,  
accessory 12401160:

