

OMF 2x6000 SM

Sabit çalışma için FibreDrain® yağ duman toplayıcı.



Nederman OMF yağ buharı toplayıcıları kesintisiz çalışma sırasında büyük miktarlarda emülsiyon buharı işlemek üzere tasarlanmıştır. Düşük bakım giderleriyle birlikte yüksek etkinliğe sahip filtreleme işlemlerine odaklanarak geliştirilmişlerdir.

Nederman OMF 2x6000 standart olarak ilk 2 kademesi Nederman'ın FibreDrain® teknolojisine sahip filtre kasetlerinden oluşan toplamda 3 adet filtre kademesine sahiptir. Nederman birçok farklı uygulamaya uyum sağlayabilmek için geniş bir yelpazeye sahip farklı filtre çeşitliliğine sahiptir. Üçüncü kademe, EN1822'ye göre MPPS için %99,95 etkinlik oranına sahip H13 filtre sınıfında bir HEPA filtreden oluşmaktadır. Bütün kule yapılı Nederman OMF üniteleri ön filtre kullanımı için hazırlanmaktadır. OMF 2x6000 ise üst montajlı bir radyal fana sahiptir.

- Üç filtre aşamalı, opsiyonlu ön filtre
- Her bir filtre kademesinde basınç düşüşlerini okumak için ölçüm aletleri
- Drain: 4 off 1 1/2"
- Non-vibration fan suspension system

Medya	OMF 2x6000 SM
Standart	2009/125/EC
Miktar(Gemi End) (m ³)	15.4
Ses Düzeyi(dB(A))	< 70 dB(A) @1,5 m from service side with optional fan enclosure and silencer
Koruma sınıfı	IP55
Filtreleme kalitesi (%)	99,95
Kurulum	[Indoor]
Materyal	Hem içi hem dışı boyalı sac metal
Filtre temizlik metodu	kendiliğinden boşaltma
Çalışma Basıncı (kPa)	Maksimum 4600 Pa
Kapasite(maks. Hava debisi m ³ /h)	12000
Operating Temperature	60 derece C (filtre ile sınırlama)
Güç Volt (V)	400/690
Frekans(Hz)	50
Faz adedi	3
Filtre adedi	18
Amper(A)	26 / 15,1
Renk	NCS-S 1005 B20G
Ağırlık (kg)	1810
Güç (kW)	15
Teknik bilgi onayı	Artı 6 opsiyonel filtre elemanı.















OMF 2x6000 SM

[image]	Bilgi Dökümanı ismi	[model]
	OMF 2x6000, Giriş flanşı 560x560mm sol. Tahliye 4 x 1 ½" Dişi.	12401155*
	OMF 2x6000, Giriş flanşı 560x560mm sağ. Tahliye 4 x 1 ½" Dişi.	12401156*

*Artı 6 opsiyonel filtre elemanı.

OMF 2x6000 SM

	[accessory]	[partno]
	Tahliye pompa kutusu, 50 Hz	12400054*
	Drain container with piping	12400764**
	Opsiyonlu fiber tahliye ön filtresi ORF 610x610x96 mm.	12400039
	FibreDrain Filter 1 OMF; 600x600x292 mm	12400009
	FibreDrain Filter 2 OMF; 600x600x292 mm	12400010
	HEPA Filter H13; 610x610x292 mm	12400012
	Inlet adapter OSF 4x3000, OMF 3x4000, OMF 2x6000	12401163
	Extension structure OMF 2x6000	12401169
	Fan enclosure 3 filters in depth	12401160
	Silencer 90° Ø 630 mm	12401159
	Drain pump box, 50 Hz, 10 litre/min at 10m, including controller	12401330
	OSF/OMF Instruction manual for mounting system for electric components	12401342
	OMF/OSF/MQL mounting system for electrical components	12401341

*Drenaj bağlantısı pompa kutusu destek seviyesinden minimum 200 mm yükseltilmelidir.

**Drain connection must be elevated min 420mm from container support level

OMF 2x6000 SM

OMF 2x6000 assembly of options:



OMF 2x6000 SM

OMF 2x6000 complete with options:



OMF 2x6000 SM

OMF 2x6000 with inlet from left side:

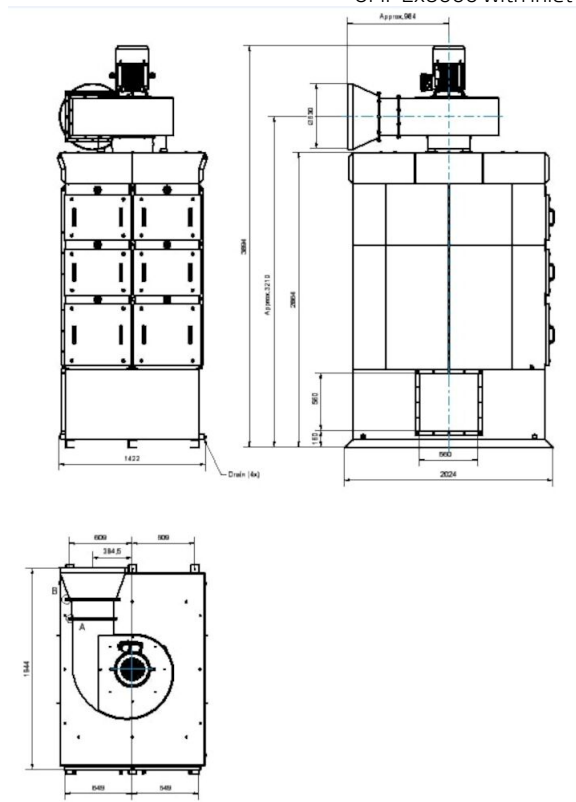

OMF 2x6000 SM

OMF 2x6000 with inlet from right side:

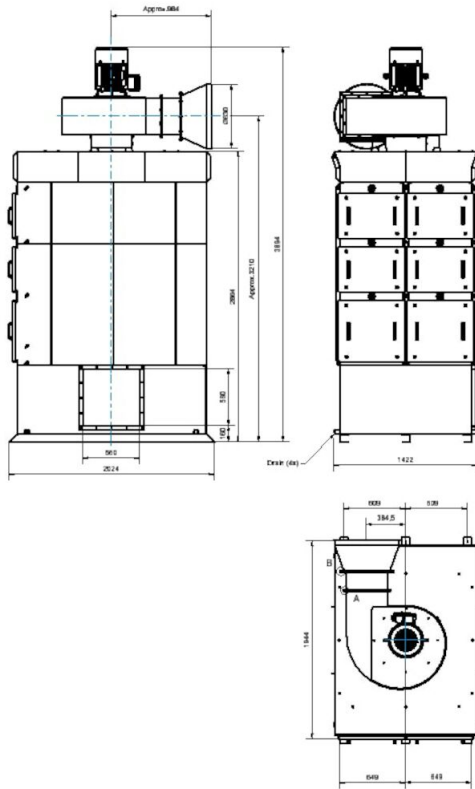

OMF 2x6000 SM

Dimension Inlet Adapter OSF4x3000_OMF3x4000_2x6000,
accessory 12401163:

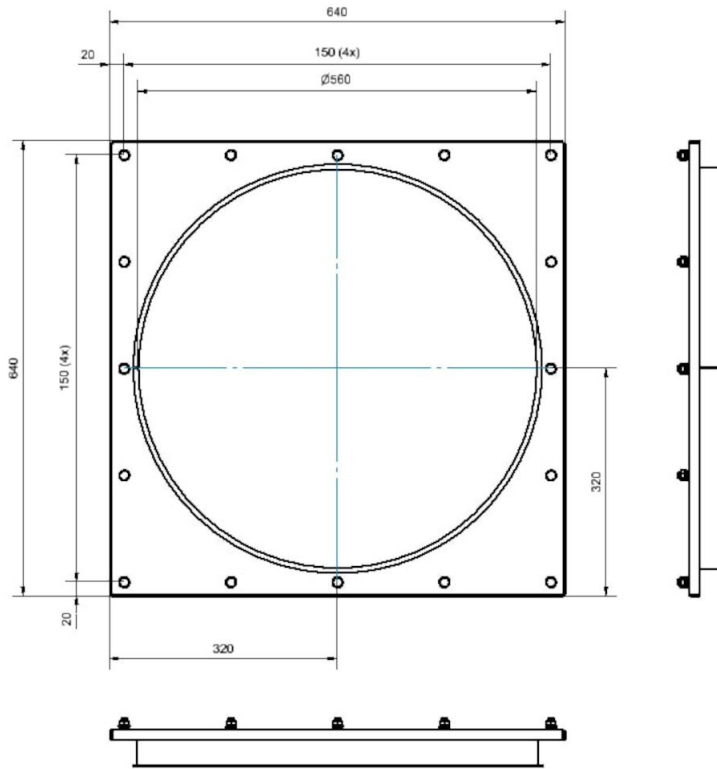

OMF 2x6000 SM

Dimension Extensions Structure OMF2x6000,
accessory 12401169:

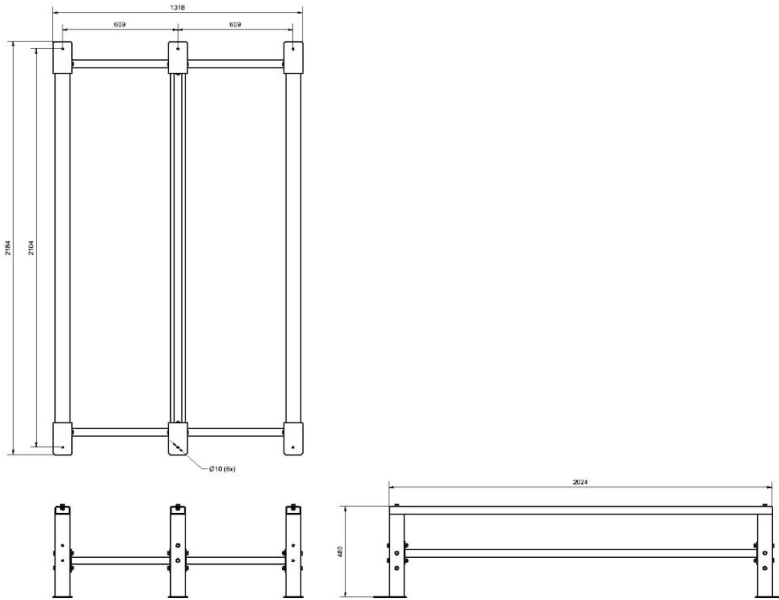

Dimension Fan Enclosure OSF4x3000_OMF2x6000,
accessory 12401160:

