

## OSF 4x2000 SM

FibreDrain® olierook afzuiging voor continue operatie

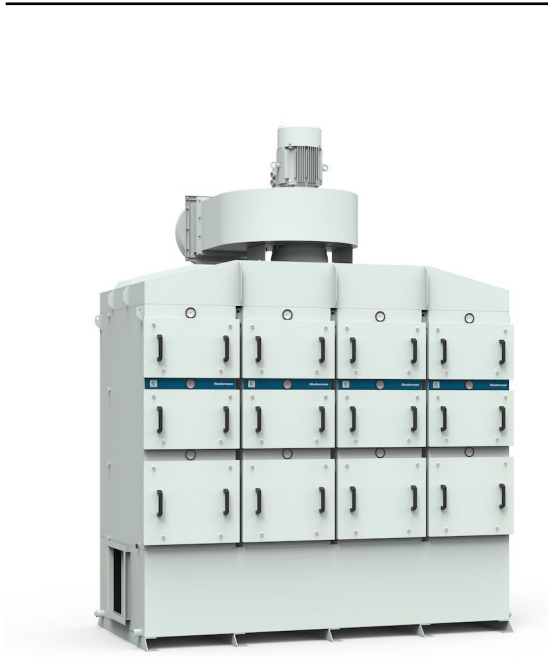

Nederman OSF olienevelfilters zijn ontworpen om grote hoeveelheden olienevel en oliemist te filteren tijdens continue processen. De filters zijn ontwikkeld met focus op hoge efficiënte filtratie gecombineerd met lage onderhoudskosten.



Nederman OSF 4x2000 SM heeft standaard een 3 traps filtersysteem waarbij de eerste 2 trappen bestaan uit filtercassettes met Nederman FibreDrain® technologie. Nederman heeft een breed scala aan diverse types voor vele applicaties. De 3e trap van filtering bestaat uit een HEPA filter met klasse H13 met een efficiëntie van 99,95% voor MPPS volgens de EN1822. Alle modulaire Nederman filters zijn geschikt voor gebruik van een voorfilter. De OSF 4x2000 SM heeft een geïntegreerde ventilator.

- Drie filter trappen, optioneel voorfilter
- Meters voor aflezen van drukverlies over elke filter trap
- Drain: 4 off 1 1/2"
- Non-vibration fan suspension system

Product naam	OSF 4x2000 SM
Standaard	2009/125/EC
Volume (transport) (m <sup>3</sup> )	14.4
Geluidsniveau (db(A))	< 70 dB(A) @1,5 m from service side with optional fan enclosure and silencer
Beschermingsklasse	IP55
Filter efficiëntie (%)	99,95
Installatie	Binnen
Materiaal	Plaatstaal, gespoten inwendig en uitwendig
Filter reinigingsmethode	[Draining]
Werkdruk (kPa)	Max 4500 Pa
Capaciteit (max. luchtstroom m <sup>3</sup> per uur)	8000
Temperatuurbereik	60° C (geïntegreerde ventilator)
Voltage (V)	400/690
Frequentie (Hz)	50
Aantal fase	3
Aantal filterelementen	24
Amperage (A)	19,5/11,3
Kleur	NCS-S 1005 B20G
Gewicht (kg)	2980
Vermogen (kW)	11
Toelichting van technische gegevens	Plus 8 optionele filter elementen.



## OSF 4x2000 SM

Afbeelding	Naam voor Datasheet	Model
	OSF 4x2000, Inlaatflens 450x450mm links. Drain 4 x 1 ½" Vrouwelijk.	12401145*
	OSF 4x2000, Inlaatflens 450x450mm rechts. Drain 4 x 1 ½" Vrouwelijk.	12401146*

*\*Plus 8 optionele filter elementen.*

## OSF 4x2000 SM

Toebehoren		Artikelnummer
	Drain pump box, 50 Hz, 10 litre/min at 5m, including controller	12400054*
	Drain container with piping	12400764**
	Optional FibreDrain Pre Filter ORF 610x610x96 mm.	12400039
	FibreDrain Filter 1 OSF; 600x600x292 mm	12400006
	FibreDrain Filter 2 OSF; 600x600x292 mm	12400007
	HEPA Filter H13; 610x610x292 mm	12400012
	Inlet adapter OSF 4x2000, OMF 2x4000	12401161
	Extension structure OSF 4x2000	12401166
	Fan enclosure 2 filters in depth	12401109
	Silencer 90° Ø 500 mm	12400038
	Drain pump box, 50 Hz, 10 litre/min at 10m, including controller	12401330
	OSF/OMF Instruction manual for mounting system for electric components	12401342
	OMF/OSF/MQL mounting system for electrical components	12401341
	Frequentieregelaar met 5 kPa druksensor, 11 kW	73008918
	Frequentieregelaar met 5 kPa druksensor, 15 kW	73008919

\*Drain connection must be elevated min 200 mm from pump box support level

\*\*Drain connection must be elevated min 420mm from container support level

# OSF 4x2000 SM

OSF 4x2000 complete with options:

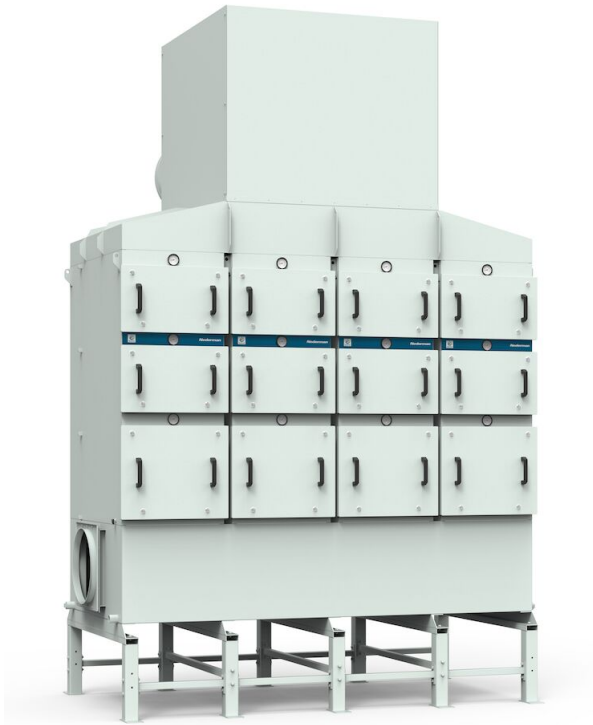

## OSF 4x2000 SM

OSF 4x2000 assembly of options:



## OSF 4x2000 SM

OSF 4x2000 with inlet from left side:

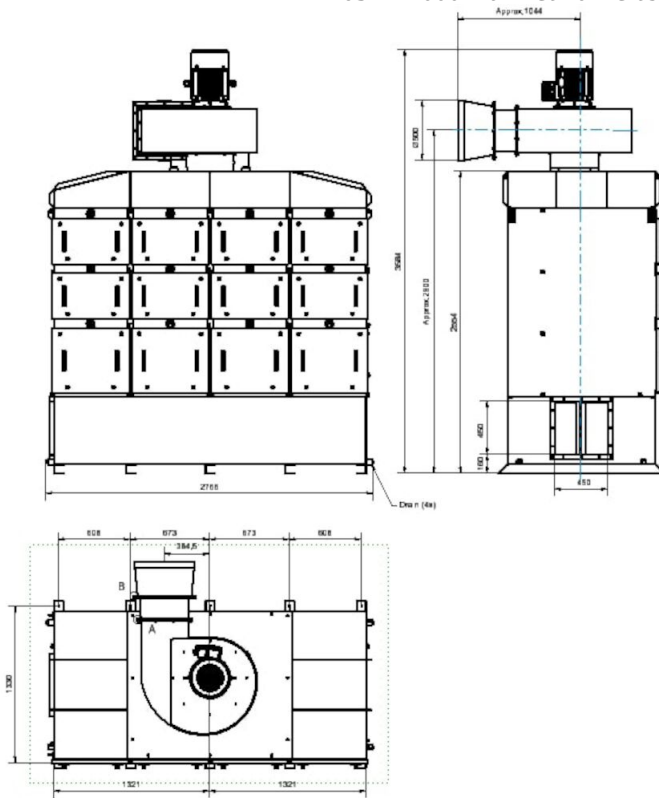

## OSF 4x2000 SM

OSF 4x2000 with inlet from right side:

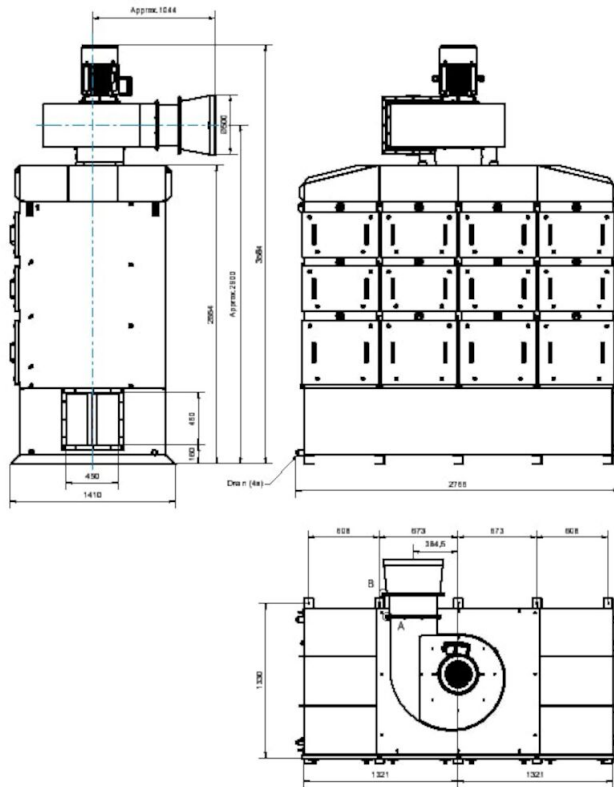

Dimension Extension Structure OSF4x2000,  
accessory 12401166:

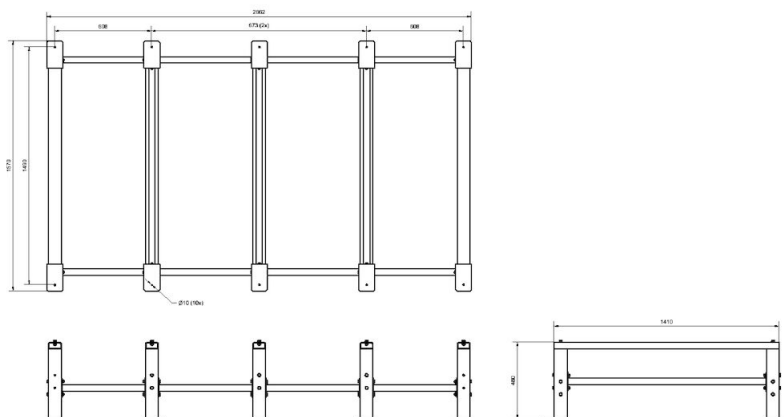

## OSF 4x2000 SM

Dimension Fan Enclosure\_OSF2x2000\_3x2000\_4x2000\_5x2000\_OMF2x4000\_4x4000,  
accessory 12401109:

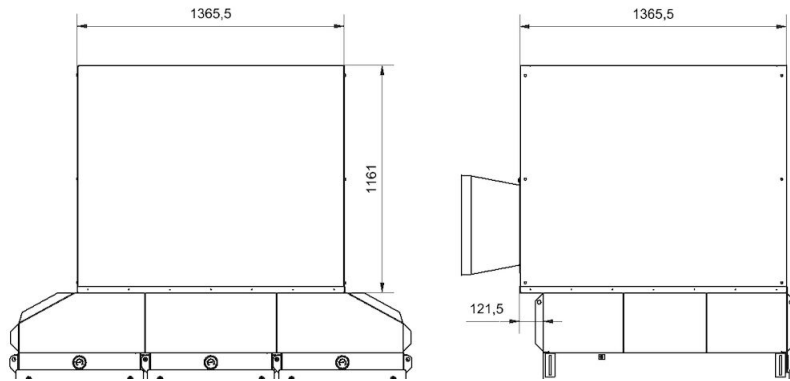

Dimension Inlet Adapter OSF4x2000\_OMF2x4000,  
accessory 12401161:

