

## OSF 1000 FC

FibreDrain® olietågefilter (ren olie) for kontinuerlig drift.



Nederman OSF olietågefilter er designet til at håndtere store mængder af ren olietåge under kontinuerlig drift. Filteret er udviklet med fokus på effektiv filtrering og lave vedligeholdelsesomkostninger.



Nederman OSF 1000 FC har som standard filtrering på 3 trin, hvor de første 2 trin er forsynet med filterkassetter med Nederman's FibreDrain® teknologi. Nederman har en bred vifte af filtre, der passer til mange forskellige anvendelsesområder. Det tredje trin er forsynet med et HEPA filter i filterklasse H13 med en effektivitet på 99,95% for MPPS i henhold til EN1822. OSF 1000 FC har indbygget radial ventilator.

- Tre filter trin
- Målere til registrering af trykfald over hvert filter trin
- Kompakt design
- To indløb  $\varnothing$  200 mm med spændering
- Starter og motorbeskyttelse inkluderet











Produkt navn	OSF 1000 FC
Standarder	2009/125/EC
Volumen (for fragt m <sup>3</sup> )	1,72
Lydniveau (dB(A))	50 Hz: 65 dB(A) @1,5 m fra service side 60 Hz: 67 dB(A) @1,5 m fra service side
Beskyttelsesklasse	IP55
Filter udskilningsgrad (%)	99,95
Installation	Indendørs
Materiale	Metalplade, malet både ind- og udvendigt
Metode for filterrensning	[Draining]
Arbejdstryk (kPa)	Max 2500 Pa
Kapacitet (max luftvolumen m <sup>3</sup> /h)	1000
Driftstemperatur	40°C (indbygget ventilator)
Spænding (V)	230/400
Frekvens (Hz)	50
Faser	3
Antal filter	3
Strøm (A)	4,2 / 2,4
Farve	NCS-S 1005 B20G
Vægt (kg)	200
Effekt (kW)	1,1
Afklaring af tekniske data	



# OSF 1000 FC

Billede	Beskrivelse	Model
	OSF 1000 FC, Indgang 1 x ø 200 mm studs, højre eller bagpå. Dræn 1", Hun	12400005
	OSF 1000 FC, Indgang 1 x ø 200 mm studs, venstre eller bagpå. Dræn 1", Hun	12400196

## OSF 1000 FC

	Tilbehør	Artikelnummer
	Drain pump box, 60 Hz, 10 litre/min at 10m, excluding controller	12401331*
	Drain pump box, 50 Hz, 10 litre/min at 5m, including controller	12400054**
	Drain container with piping	12400764***
	FibreDrain Filter 1 OSF; 600x600x292 mm	12400006
	FibreDrain Filter 2 OSF; 600x600x292 mm	12400007
	HEPA Filter H13; 610x610x150 mm	12400852
	High capacity HEPA-filter kit for FC	12400984
	Outlet connection OSF 1000FC / OMF 2000FC - HEPA 610x610x292mm	12400726
	Outlet connection OSF 1000FC / OMF 2000FC - HEPA 610x610x150mm	12400959
	Drain pump box, 50 Hz, 10 litre/min at 10m, including controller	12401330
	Frekvensomformer med 2kPa tryktransmitter. 1,5 kW	73008913

\*Controller available on request

\*\*Drain connection must be elevated min 200 mm from pump box support level

\*\*\*Drain connection must be elevated min 420mm from container support level

## OSF 1000 FC

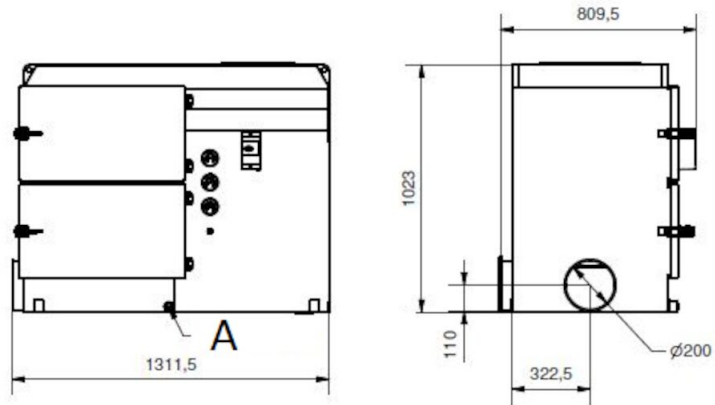

A)Drænstud (x2)

Dimensions for outlet connection:

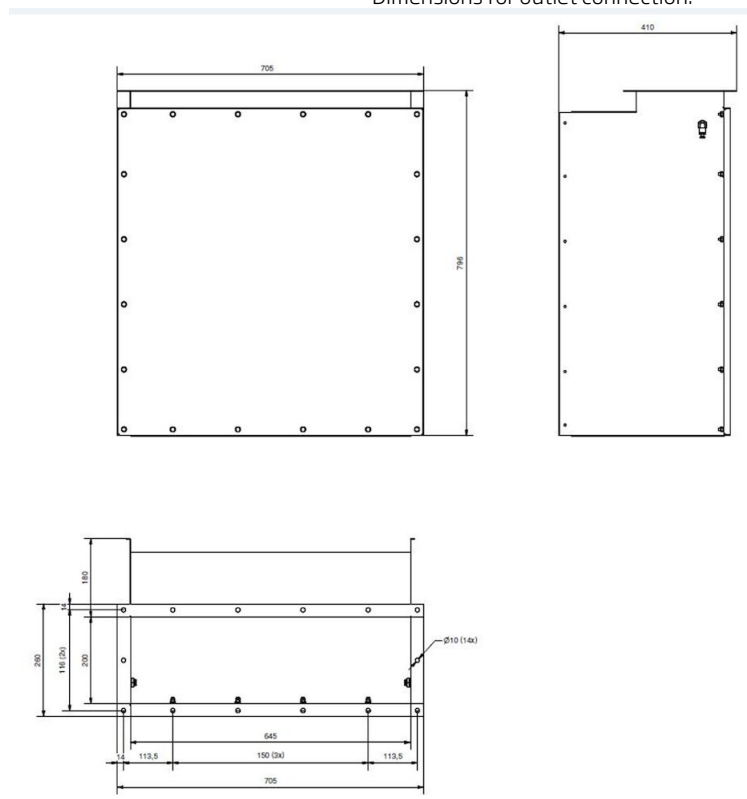

## OSF 1000 FC

Dimensions for outlet connection:

