

Benkutsugsarm FX32 ESD

Fleksibel benkavsugsarm

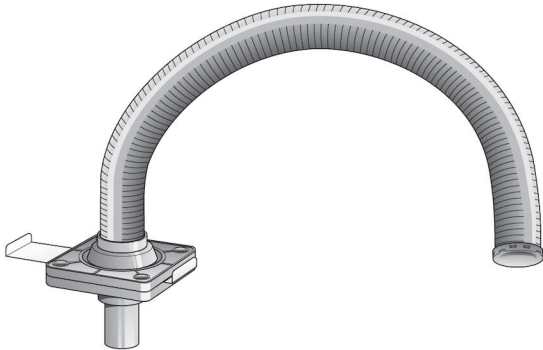

Avsugsarmen for elektronikkindustrien, laboratorier, skoler osv. Fleksibel plastslange med en meget god bestandighet overfor løsemidler m. m. Forblir i ny posisjon når justert. ESD-sikker. Svivel med 360 graders rotasjon. Det betyr at de tilkoblede kanalene forblir faste og roteres ikke med armen. Montering rett på benkeplaten eller med tilhørende brakett. Kan monteres både stående og hengende.





Produktnavn	Benkutsugsarm FX32 ESD
Støynivå (dB(A))	48
Installasjon	Innendørs
Ekstraheringsarm, diameter (mm)	32
Luftstrøm (m ³ /t)	20-45
Armlengde (m)	1



Benkutsugsarm FX32 ESD

Navn på datablad	Model
FX 32 ESD	70502934

Benkutsugsarm FX32 ESD

	Tilbehør	Artikkelnummer
	Sugehette 1/2 for FX 32 ESD	70371807
	Sugehette 1/1 for FX 32 ESD	70371808
	Bordbrakett,75/50/32 Std/ESD/PP	70371761
	Veggbrakett FX 32 Std/ESD/PP	70371760

Benkutsugsarm FX32 ESD

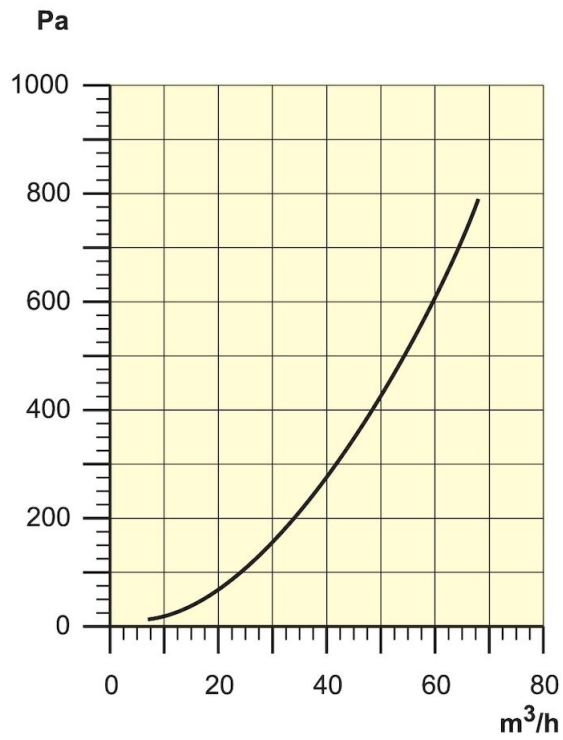

Pressure Drop

Benkutsugsarm FX32 ESD

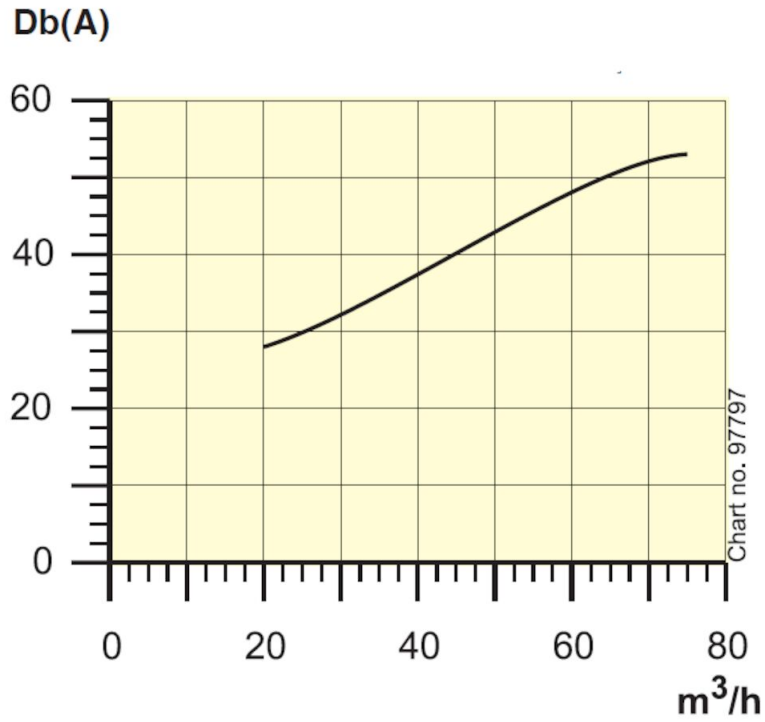

Sound Level
Distance to measuring point = 1m

Benkutsugsarm FX32 ESD

