

MCP SmartFilter

Cartridge filter for both indoor and outdoor installations. The filter can be used for many different dust producing industries.

MCP SmartFilter



MCP SmartFilter is a multi-purpose filtration system. It is customizable to perfectly fit customer specific demands with airflow up to 28 000 m³/h. Suitable for smoke, fumes and dust and can be used in several different applications such as welding, metal cutting and general dust.

The modular design allows for standalone solutions as well as multi-filter solutions for extended requirements. With a new and innovative cartridge design - the squircle shape utilizes the square space within the dust collector in the most optimal way and generates high cartridge airflow. Thus, decreasing the size and hence the footprint of the system.

Constructed with 2 mm galvanized steel panels, it is easy to install, cost effective to ship and provides corrosion protection. The design is optimized for long filter lifetime providing low cost of ownership. Insight ready control with advanced pulse cleaning logic provides for full system operation including control and monitoring, as well as gateway functionality for cloud communication.

The MCP SmartFilter has a large accessories program including; fans, inlets, bins etc. and the cartridges are available in a wide variety of materials.









- Gain control over filtration performance with Insight Analytics. Nederman's unique monitoring technology
- Optimized footprint through innovative cartridge design with high airflow
- Reduced TCO through intelligent cleaning system, long filter cartridge life-time and optimized footprint
- Future Proof system that is IoT prepared- Insight Ready
- Controller, HMI and Gateway all in one unit with the Insight Control Panel.

Product name	MCP SmartFilter
Compressed air consumption	60 litres per cleaning pulse at 6,0 bar compressed air
Installation	[Indoor], [Outdoor]
Material	2 mm galvanised sheet metal
Suitable for combustible dust	False
Filter cleaning method	[Pulsejet]
Application	[fumes], [dust]
Working pressure (psi)	Vacuum max. 6 kPa. Overpressure max. 0 Pa. (1,5 kPa for silotop solution)
Dustbin volume (gal)	50 or 100 litre bin
Filter Area (ft ²)	Polyester: 30 to 192 m ² SC178: 67 to 422 m ² SC179: 32 to 208 m ²
Capacity (max airflow cfm)	4500 to 28000
Operating Temperature	-20 to +70 Deg. C.
Filter type	[cartridge]
Filter material	Depending on application
Colour	

MCP SmartFilter

Fumes Dust

MCP SmartFilter

[image]	Description	Number of filter elements	[model]
	MCP-2-BS SmartFilter	8	MCP-2-BS*
	MCP-4-16S SmartFilter	16	MCP-4-16S
	MCP-4-16S SmartFilter	24	MCP-6-24S
	MCP-4-16S SmartFilter	32	MCP-8-32S
	MCP-2-BSL SmartFilter	8	MCP-2-BSL
	MCP-4-16SL SmartFilter	16	MCP-4-16SL
	MCP-6-24SL SmartFilter	24	MCP-6-24SL
	MCP-8-32SL SmartFilter	32	MCP-8-32SL

*Configured product

MCP SmartFilter

Cartridge material

- SC100 – Spunbond polyester
- SC140 – Spunbond polyester with antistatic treatment
- SC141 – Spunbond polyester with antistatic treatment and PTFE coating
- SC150 – Spunbond polyester with ePTFE membrane
- SC151 – Spunbond polyester with antistatic treatment and ePTFE membrane
- SC178/SC179 – 80% cellulose, 20% polyester material with nanofiber
- SC190 – Spunbond polyester with PTFE coating

A – Height of Clean Air Chamber (mm)

200	350	500	650
Shown in drawings	Add 150 mm in height	Add 300 mm in height	Add 450 mm in height











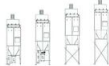

Filter area

Filter type	Quantity of cartridges	Filter area (m ²)			Max. airflow (m ³ /h)*
		SC100, SC140, SC141, SC150, SC151, SC190	SC178	SC179	
MCP-2-8S MCP-2-8S-Ex	8	48,0	105,6	52,0	7000
MCP-4-16S MCP-4-16S-Ex	16	96,0	211,2	104,0	14000
MCP-6-24S MCP-6-24S-Ex	24	144,0	316,8	156,0	21000
MCP-8-32S MCP-8-32S-Ex	32	192,0	422,4	208,0	28000
MCP-2-8SL MCP-2-8SL-Ex	8	30,4	67,2	32,8	4500
MCP-4-16SL MCP-4-16SL-Ex	16	60,8	134,4	65,6	9000
MCP-6-24SL MCP-6-24SL-Ex	24	91,2	201,6	98,4	13500
MCP-8-32SL MCP-8-32SL-Ex	32	121,6	268,8	131,2	18000

*Max. air flow is dependent on the dust type, etc.

MCP SmartFilter

Accessories

Figure	Description	Figure	Description
	Top mounted FM-fans 50 Hz or 60 Hz up to 14000 m ³ /h		Leg height extensions from 0 mm to 2000 mm to fit larger bins/containers, rotary valves and big bags
	Combifab remote fans 50 Hz or 60 Hz		Leg width extension 300 mm to left, right or both sides to fit larger bins/containers, rotary valves and big bags
	Noise enclosure to reduce fan and motor break-out-noise of FM-fans		Suspension below rotary valve for big bag
	Dual silencer to reduce air flow, fan noise and motor break-out-noise of FM-fans (available with grid (indoor use), grid and rain cover (outdoor use) or flange for duct connection)		Isolation box for pressure tank incl. clearing valves
	Regulation (iris) damper at fan inlet for FM-fans		Access platform with ladder for maintenance
	Dust bins (50 l, 50 l with wheels and 100 l with wheels)		Lime feeder NFKG-70
	Plastic bag in the dust bin with pressure compensation set 'bin balancing'		Several sensors available for extraction, filtration and discharge process
	Rotary valves NRS3 and NRSZ3		Water separator and pressure regulator
	Dust discharge valve NFUS3		QF-duct system

MCP SmartFilter

MCP-2-8S / MCP-2-8S-Ex
MCP-2-8SL / MCP-2-8SL-Ex

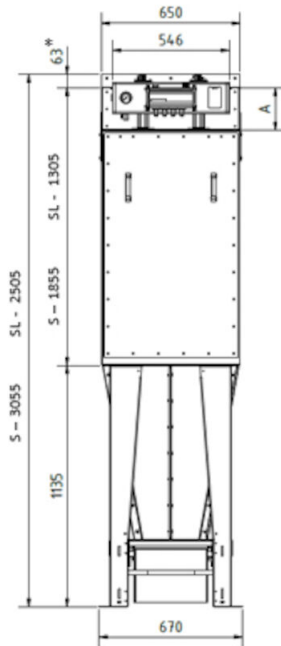

All dimensions in mm.

If 50 liter bin with wheels 90 mm must be added to the height.

* to be included only if a top mounted FM fan is used (transition for fan).

MCP SmartFilter

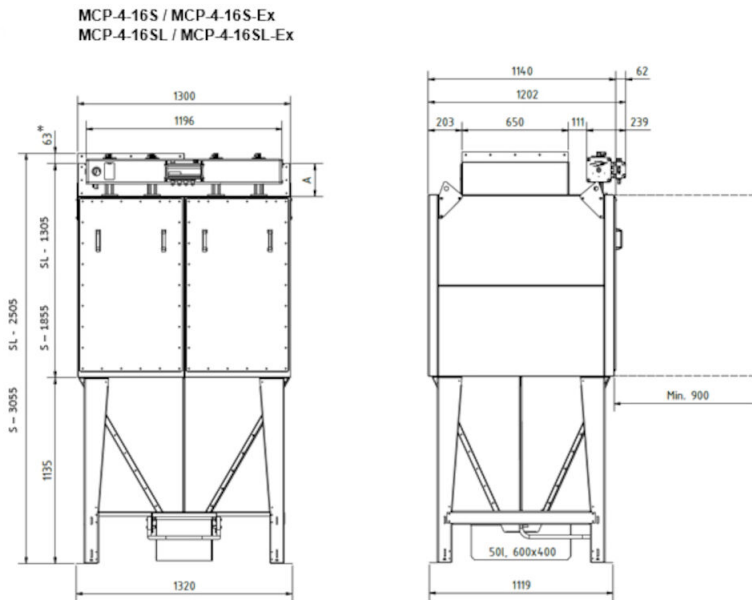

All dimensions in mm.

If 50 liter bin with wheels 90 mm must be added to the height.

* to be included only if a top mounted FM fan is used (transition for fan).

MCP SmartFilter

MCP-6-24S / MCP-6-24S-Ex
MCP-6-24SL / MCP-6-24SL-Ex



All dimensions in mm.

If 50 liter bin with wheels 90 mm must be added to the height.

* to be included only if a top mounted FM fan is used (transition for fan).

MCP SmartFilter

MCP-8-32S / MCP-8-32S-Ex
MCP-8-32SL / MCP-8-32SL-Ex

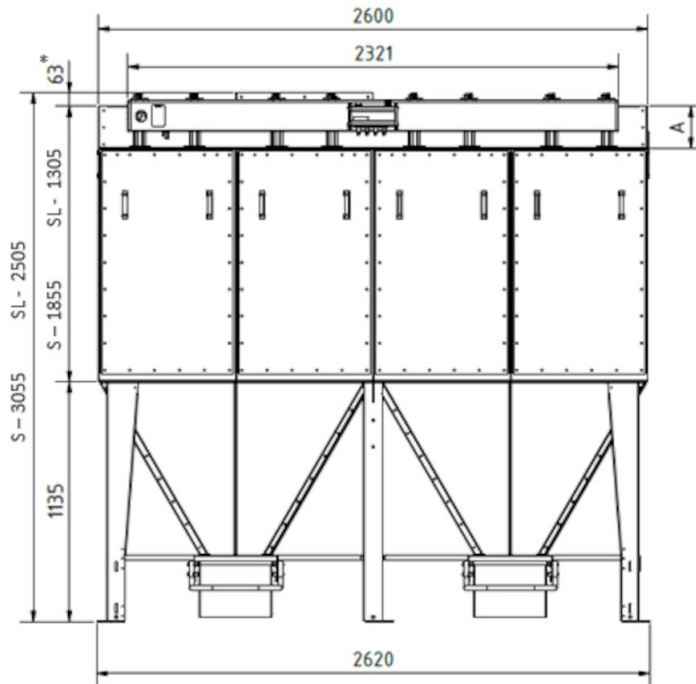

All dimensions in mm.

If 50 liter bin with wheels 90 mm must be added to the height.

* to be included only if a top mounted FM fan is used (transition for fan).