

MCP Smartfilter

Allsidig patronfilter for både innendørs og utendørs installasjoner. Brukes til mange forskjellige bransjer som metallbearbeiding, matproduksjon, farmasi, kjemi, mineraler og gruvedrift, gjenvinning, kompositt, tre og andre støvproduserende prosesser.

MCP Smartfilter



MCP SmartFilter er et flerbruks-filtreringssystem. Det kan tilpasses for å passe perfekt til kundespesifikke krav med luftstrøm opp til 28 000 m³ / t. Egnert for røyk og støv og kan brukes i flere forskjellige bruksområder som sveising, metallskjæring og generelt støv. Den modulære utformingen gir mulighet for frittstående løsninger og multifilterløsninger for utvidede krav. Med en ny og innovativ patrondesign utnytter "squirkelformen" den firkantede plassen i støvoppsamleren på den mest optimale måten og genererer høy luftstrøm gjennom patronfilteret. Dermed reduseres størrelsen og derav fotavtrykket til systemet.

Konstruert med 2 mm galvaniserte stålplater. Det er enkelt å montere, kostnadseffektivt å sende og gir korrosjonsbeskyttelse. Designet er optimalisert for lang filterlevetid og gir lave eierkostnader.

Insight med avansert pulsrengjøringslogikk gir full systemoversikt inkludert kontroll og overvåking, samt gateway-funksjonalitet for skykommunikasjon.

MCP SmartFilter har et stort tilbehørsprogram inkludert; vifter, innløp, kasser osv. og patronfilterene er tilgjengelige i et bredt utvalg av materialer.

- Få kontroll over filtreringssystemet med Insight Analytics. Nedermans unike overvåkingsteknologi
- Optimalisert fotavtrykk gjennom innovativ patrondesign med høy luftstrøm
- Redusert livstidskostnad gjennom intelligent rengjøringsystem, lang levetid for filterkassetter og optimalisert fotavtrykk
- Fremtidsrettet system som er IoT forberedt - Insight Ready
- Kontroller, HMI og Gateway alt i en enhet med Insight Control Panel.









Produktnavn	MCP Smartfilter
Trykkluftforbruk	60 liter per rengjøringspuls ved 6,0 bar trykkluft
Installasjon	Innendørs, Utendørs
Materiale	2 mm galvanisert stål
Egnet for brennbar støv	False
Rengjøringsmetode, filter	Trykkluftrensing
Bruksområde	Røyk, Støv
Arbeidstrykk (kPa)	Vakuüm maks -6 kPa
Volum, støvbeholder (L)	50 eller 100 liters beholder
Filterområdet (m ²)	Polyester: 30 til 192 m ² SC178: 67 til 422 m ² SC179: 32 til 208 m ²
Kapasitet (maks. luftstrøm m ³ /t)	4500 til 28000 m ³ /t
Driftstemperatur	-20 to +70 Deg. C.
Filtertype	Kassetfilter

MCP Smartfilter

Filtermateriale	Avhenger av bruksområde
Farge	
Avklaring av teknisk informasjon	Konfigurert produkt



MCP Smartfilter

Bilde	Navn på datablad	Antall filterelementer	Model
	MCP-2-8S SmartFilter	8	MCP-2-8S*
	MCP-4-16S SmartFilter	16	MCP-4-16S*
	MCP-6-24S SmartFilter	24	MCP-6-24S*
	MCP-8-32S SmartFilter	32	MCP-8-32S*
	MCP-2-8SL SmartFilter	8	MCP-2-8SL*
	MCP-4-16SL SmartFilter	16	MCP-4-16SL*
	MCP-6-24SL SmartFilter	24	MCP-6-24SL*
	MCP-8-32SL SmartFilter	32	MCP-8-32SL*

*Konfigurert produkt

MCP Smartfilter

Cartridge material

- SC100 – Spunbond polyester
- SC140 – Spunbond polyester with antistatic treatment
- SC141 – Spunbond polyester with antistatic treatment and PTFE coating
- SC150 – Spunbond polyester with ePTFE membrane
- SC151 – Spunbond polyester with antistatic treatment and ePTFE membrane
- SC178/SC179 – 80% cellulose, 20% polyester material with nanofiber
- SC190 – Spunbond polyester with PTFE coating

A – Height of Clean Air Chamber (mm)

200	350	500	650
Shown in drawings	Add 150 mm in height	Add 300 mm in height	Add 450 mm in height











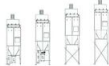





Filter area

Filter type	Quantity of cartridges	Filter area (m ²)			Max. airflow (m ³ /h)*
		SC100, SC140, SC141, SC150, SC151, SC190	SC178	SC179	
MCP-2-8S MCP-2-8S-Ex	8	48,0	105,6	52,0	7000
MCP-4-16S MCP-4-16S-Ex	16	96,0	211,2	104,0	14000
MCP-6-24S MCP-6-24S-Ex	24	144,0	316,8	156,0	21000
MCP-8-32S MCP-8-32S-Ex	32	192,0	422,4	208,0	28000
MCP-2-8SL MCP-2-8SL-Ex	8	30,4	67,2	32,8	4500
MCP-4-16SL MCP-4-16SL-Ex	16	60,8	134,4	65,6	9000
MCP-6-24SL MCP-6-24SL-Ex	24	91,2	201,6	98,4	13500
MCP-8-32SL MCP-8-32SL-Ex	32	121,6	268,8	131,2	18000

*Max. air flow is dependent on the dust type, etc.

MCP Smartfilter

Accessories

Figure	Description	Figure	Description
	Top mounted FM-fans 50 Hz or 60 Hz up to 14000 m ³ /h		Leg height extensions from 0 mm to 2000 mm to fit larger bins/containers, rotary valves and big bags
	Combifab remote fans 50 Hz or 60 Hz		Leg width extension 300 mm to left, right or both sides to fit larger bins/containers, rotary valves and big bags
	Noise enclosure to reduce fan and motor break-out-noise of FM-fans		Suspension below rotary valve for big bag
	Dual silencer to reduce air flow, fan noise and motor break-out-noise of FM-fans (available with grid (indoor use), grid and rain cover (outdoor use) or flange for duct connection)		Isolation box for pressure tank incl. clearing valves
	Regulation (iris) damper at fan inlet for FM-fans		Access platform with ladder for maintenance
	Dust bins (50 l, 50 l with wheels and 100 l with wheels)		Lime feeder NFKG-70
	Plastic bag in the dust bin with pressure compensation set 'bin balancing'		Several sensors available for extraction, filtration and discharge process
	Rotary valves NRS3 and NRSZ3		Water separator and pressure regulator
	Dust discharge valve NFUS3		QF-duct system

MCP Smartfilter

MCP-2-8S / MCP-2-8S-Ex
MCP-2-8SL / MCP-2-8SL-Ex

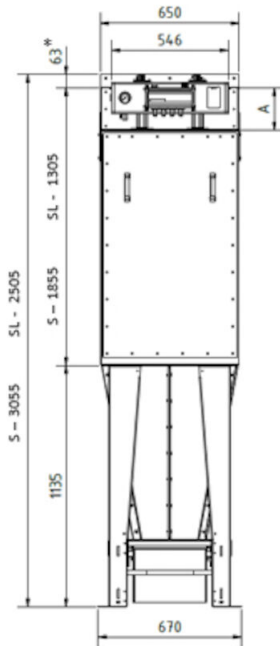

All dimensions in mm.

If 50 liter bin with wheels 90 mm must be added to the height.

* to be included only if a top mounted FM fan is used (transition for fan).

MCP Smartfilter

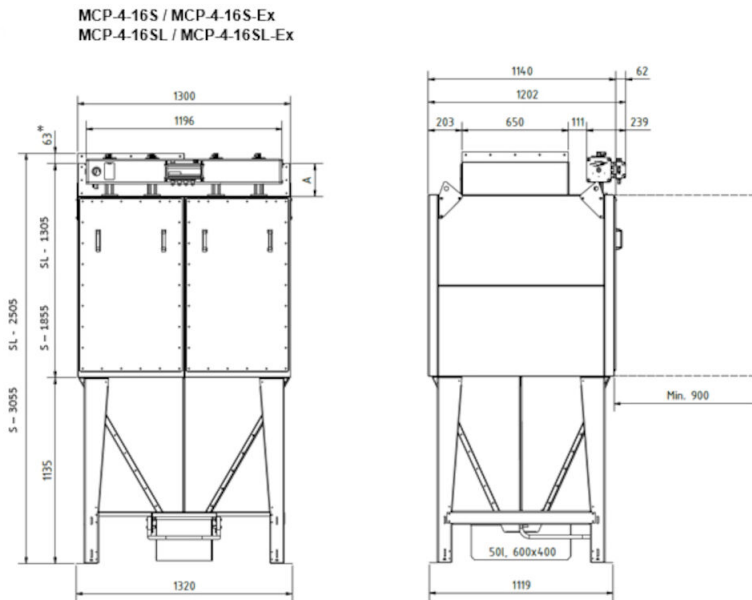

All dimensions in mm.

If 50 liter bin with wheels 90 mm must be added to the height.

* to be included only if a top mounted FM fan is used (transition for fan).

MCP Smartfilter

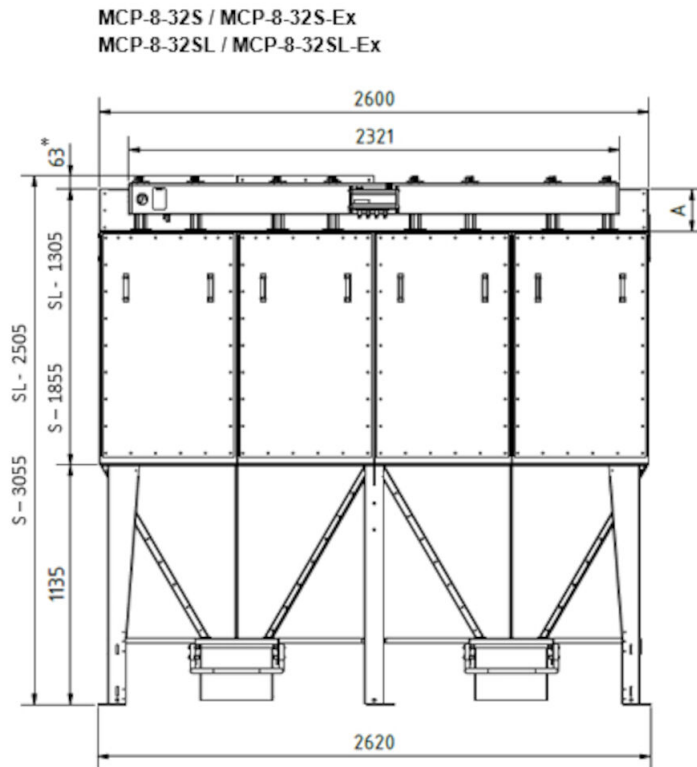

All dimensions in mm.

If 50 liter bin with wheels 90 mm must be added to the height.

* to be included only if a top mounted FM fan is used (transition for fan).