

MCP SmartFilter Ex

MCP SmartFilter Ex er et flerbruksfiltreringssystem for både innendørs og utendørs installasjoner. Det er egnet for røyk, støv og brennbart støv og kan brukes til mange forskjellige bransjer.

MCP SmartFilter Ex



MCP SmartFilter er et flerbruks-filtreringssystem. Det kan tilpasses for å passe perfekt til kundespesifikke krav med luftstrøm opp til 28 000 m³ / t. Egnert for røyk og støv og kan brukes i flere forskjellige bruksområder som sveising, metallskjæring og generelt støv. Den modulære utformingen gir mulighet for frittstående løsninger og multifilterløsninger for utvidede krav. Med en ny og innovativ patrondesign utnytter "squirkelformen" den firkantede plassen i støvoppsamleren på den mest optimale måten og genererer høy luftstrøm gjennom patronfilteret. Dermed reduseres størrelsen og derav fotavtrykket til systemet.

Konstruert med 2 mm galvaniserte stålplater. Det er enkelt å montere, kostnadseffektivt å sende og gir korrosjonsbeskyttelse. Designet er optimalisert for lang filterlevetid og gir lave eierkostnader.

Insight med avansert pulsrengjøringslogikk gir full systemoversikt inkludert kontroll og overvåking, samt gateway-funksjonalitet for skykommunikasjon.

MCP SmartFilter har et stort tilbehørsprogram inkludert; vifter, innløp, kasser osv. og patronfilterene er tilgjengelige i et bredt utvalg av materialer.

Den har full overensstemmelse med globale direktiver, spesielt viktig for applikasjoner med brennbart støv (ATEX). MCP SmartFilter har et stort tilbehørsprogram inkludert; vifter, innløp, kasser osv. og patronene er tilgjengelige i et bredt utvalg av materialer.

- Få kontroll over filtreringssystemet med Insight Analytics. Nedermans unike overvåkingsteknologi
- Optimalisert fotavtrykk gjennom innovativ patrondesign med høy luftstrøm
- Redusert livstidskostnad gjennom intelligent rengjøringsystem, lang levetid for filterkassetter og optimalisert fotavtrykk
- Fremtidsrettet system som er IoT forberedt - Insight Ready
- Kontroller, HMI og Gateway alt i en enhet med Insight Control Panel.









Produktnavn	MCP SmartFilter Ex
Filtereffektivitet (%)	99,9
Trykkluftforbruk	60 liter per rengjøringspuls ved 6,0 bar trykkluft
Installasjon	Innendørs, Utendørs
Materiale	Galvanisert stål
Egnet for brennbart støv	True
Rengjøringsmetode, filter	Trykkluftrensing
Bruksområde	Røyk, Støv
Arbeidstrykk (kPa)	Vakuump maks -6 kPa
Volum, støvbeholder (L)	50 eller 100 liters beholder
Filterområdet (m ²)	Polyester: 30 til 192 m ²

MCP SmartFilter Ex

Kapasitet (maks. luftstrøm m ³ /t)	4500 til 28000 m ³ /t
Driftstemperatur	-20 to +70 Deg. C.
Filtertype	Kassettfilter
Filtermateriale	Avhenger av bruksområde
Avklaring av teknisk informasjon	Konfigurert produkt



MCP SmartFilter Ex

Bilde	Navn på datablad	Antall filterelementer	Model
	MCP-2-8S-Ex SmartFilter	8	MCP-2-8S-Ex*
	MCP-4-16S-Ex SmartFilter	16	MCP-4-16S-Ex*
	MCP-6-24S-Ex SmartFilter	24	MCP-6-24S-Ex*
	MCP-8-32S-Ex SmartFilter	32	MCP-8-32S-Ex*
	MCP-2-8SL-Ex SmartFilter	8	MCP-2-8SL-Ex*
	MCP-4-16SL-Ex SmartFilter	16	MCP-4-16SL-Ex*
	MCP-6-24SL-Ex SmartFilter	24	MCP-6-24SL-Ex*
	MCP-8-32SL-Ex SmartFilter	32	MCP-8-32SL-Ex*

*Konfigurert produkt

MCP SmartFilter Ex

Product Marking of MCP SmartFilter Ex



Product marking of MCP SmartFilter Ex

Pred,max	KST	Zone Placement
0,3 bar	St1 (0 to 200 bar m s ⁻¹) St2 (> 200 to 300 bar m s ⁻¹) St3 (> 300 bar m s ⁻¹)*	None-zone Zone 22*

*Not available as standard, available by request

MCP SmartFilter Ex specifications

Cartridge material

- SC100 – Spunbond polyester
- SC140 – Spunbond polyester with antistatic treatment
- SC141 – Spunbond polyester with antistatic treatment and PTFE coating
- SC150 – Spunbond polyester with ePTFE membrane
- SC151 – Spunbond polyester with antistatic treatment and ePTFE membrane
- SC178/SC179 – 80% cellulose, 20% polyester material with nanofiber
- SC190 – Spunbond polyester with PTFE coating

A – Height of Clean Air Chamber (mm)

200	350	500	650
Shown in drawings	Add 150 mm in height	Add 300 mm in height	Add 450 mm in height











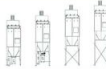





MCP SmartFilter Ex

Filter area

Filter type	Quantity of cartridges	Filter area (m ²)			Max. airflow (m ³ /h)*
		SC100, SC140, SC141, SC150, SC151, SC190	SC178	SC179	
MCP-2-8S MCP-2-8S-Ex	8	48,0	105,6	52,0	7000
MCP-4-16S MCP-4-16S-Ex	16	96,0	211,2	104,0	14000
MCP-6-24S MCP-6-24S-Ex	24	144,0	316,8	156,0	21000
MCP-8-32S MCP-8-32S-Ex	32	192,0	422,4	208,0	28000
MCP-2-8SL MCP-2-8SL-Ex	8	30,4	67,2	32,8	4500
MCP-4-16SL MCP-4-16SL-Ex	16	60,8	134,4	65,6	9000
MCP-6-24SL MCP-6-24SL-Ex	24	91,2	201,6	98,4	13500
MCP-8-32SL MCP-8-32SL-Ex	32	121,6	268,8	131,2	18000

*Max. air flow is dependent on the dust type, etc.

Accessories

Figure	Description	Figure	Description
	Top mounted FM-fans 50 Hz or 60 Hz up to 14000 m ³ /h		Leg height extensions from 0 mm to 2000 mm to fit larger bins/containers, rotary valves and big bags
	Combifab remote fans 50 Hz or 60 Hz		Leg width extension 300 mm to left, right or both sides to fit larger bins/containers, rotary valves and big bags
	Noise enclosure to reduce fan and motor break-out-noise of FM-fans		Suspension below rotary valve for big bag
	Dual silencer to reduce air flow, fan noise and motor break-out-noise of FM-fans (available with grid (indoor use), grid and rain cover (outdoor use) or flange for dust connection)		Isolation box for pressure tank incl. cleaning valves
	Regulation (iris) damper at fan inlet for FM-fans		Access platform with ladder for maintenance
	Dust bins (50 l, 50 l with wheels and 100 l with wheels)		Lime feeder NFKG-70
	Plastic bag in the dust bin with pressure compensation set 'bin balancing'		Several sensors available for extraction, filtration and discharge process
	Rotary valves NRS3 and NRSZ3		Water separator and pressure regulator
	Dust discharge valve NFUS3		QF-duct system

MCP SmartFilter Ex

MCP-2-8S / MCP-2-8S-Ex
MCP-2-8SL / MCP-2-8SL-Ex

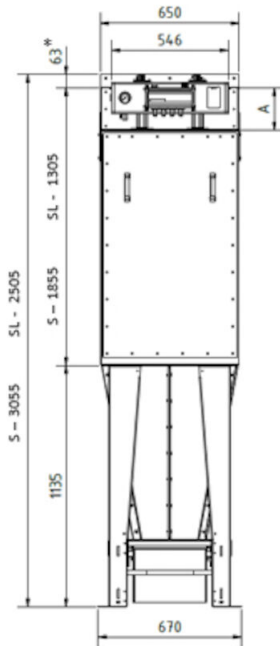

All dimensions in mm.

If 50 liter bin with wheels 90 mm must be added to the height.

* to be included only if a top mounted FM fan is used (transition for fan).

MCP SmartFilter Ex

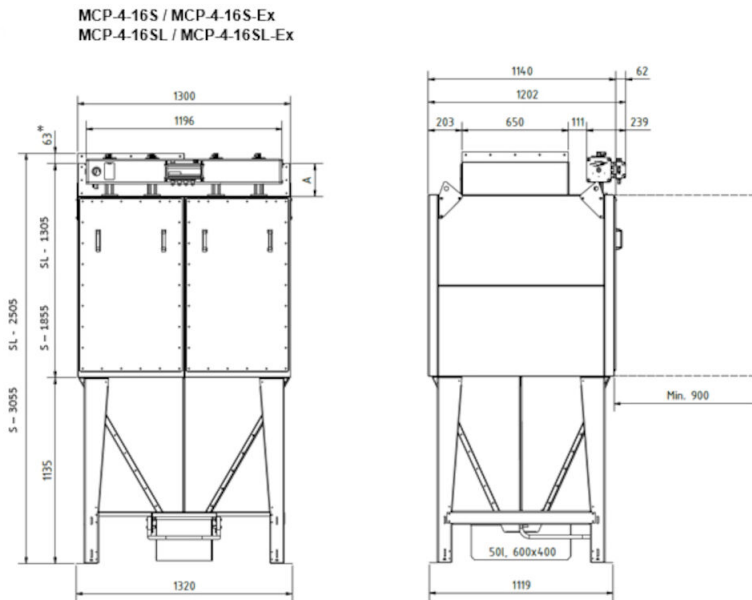

All dimensions in mm.

If 50 liter bin with wheels 90 mm must be added to the height.

* to be included only if a top mounted FM fan is used (transition for fan).

MCP SmartFilter Ex

MCP-6-24S / MCP-6-24S-Ex
MCP-6-24SL / MCP-6-24SL-Ex

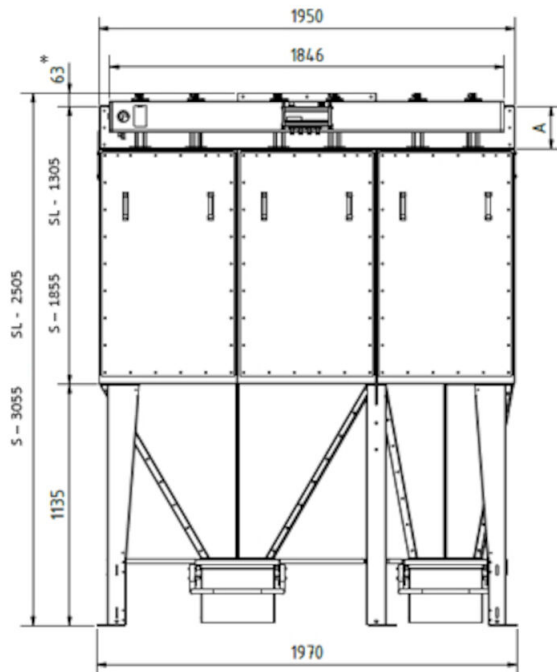

All dimensions in mm.

If 50 liter bin with wheels 90 mm must be added to the height.

* to be included only if a top mounted FM fan is used (transition for fan).

MCP SmartFilter Ex

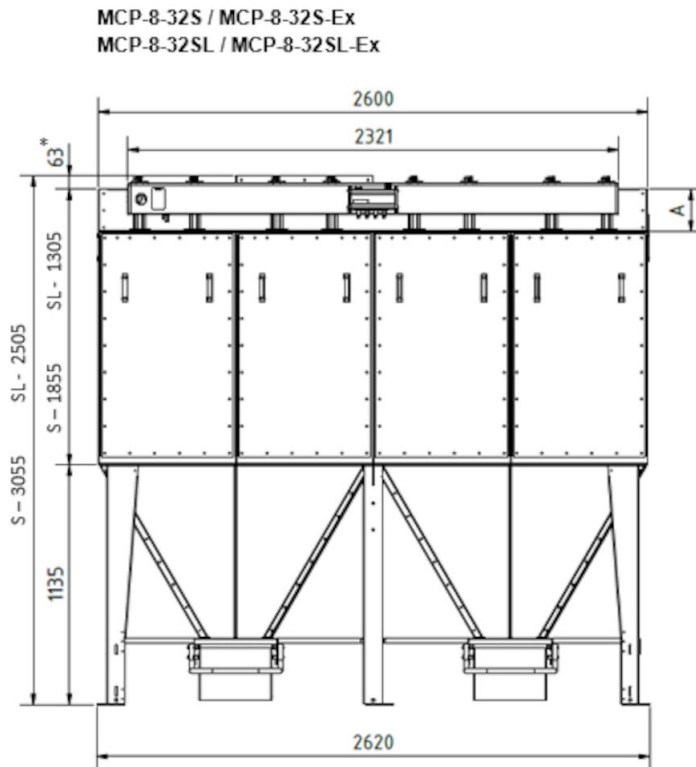

All dimensions in mm.

If 50 liter bin with wheels 90 mm must be added to the height.

* to be included only if a top mounted FM fan is used (transition for fan).