

MCP SmartFilter Ex

Het MCP SmartFilter Ex is een multifunctioneel filtersysteem voor zowel binnen- als buitenopstelling. Het filter is geschikt voor rook, dampen, stof en explosieve stoffen en kan in veel verschillende industrieën worden gebruikt.

MCP SmartFilter Ex



MCP SmartFilter is een multifunctioneel filtersysteem. Het systeem is aanpasbaar om de perfecte oplossing te bieden voor klantspecifieke wensen tot een luchtstroom van 28.000 m³ per uur. Geschikt voor het filteren van rook, dampen, stof en explosieve stoffen en inzetbaar voor verschillende toepassingen zoals, lassen, snijden en algemene stoftoepassingen. Het modulaire ontwerp maakt een stand-alone oplossing mogelijk en op een later gewenst moment kan het filtersysteem zelfs verder worden uitgebreid. Door het nieuwe innovatieve "Squirle" cartridge design wordt op de meest optimale manier een hoge luchtstroom binnen in het filter gegenereerd. Hierdoor zijn wij in staat om het filter qua omvang te verkleinen en neemt het minder ruimte in beslag. Het MCP SmartFilter is gemaakt van 2 mm plaatstaal, eenvoudig te installeren en corrosiebestendig. Het ontwerp is verder geoptimaliseerd en zorgt voor een lange levensduur van het filter en daardoor ook lagere gebruikskosten. "Insight Ready" besturing voorzien van geavanceerde pulsreiniging zorgt voor een volledige systeembediening inclusief bewaking en gateway functionaliteit voor Cloud communicatie. Het filtersysteem voldoet volledig aan de wereldwijde richtlijnen, vooral belangrijk voor toepassingen met explosiegevaarlijke stoffen (ATEX). Het MCP SmartFilter heeft een compleet programma met accessoires waaronder ventilatoren, inlaten, stofopvangbakken en een breed scala aan verschillende filtermaterialen.

- Krijg controle over uw filterprestaties met Nederman Insight Analytics. De unieke bewakingstechnologie van Nederman.
- Geoptimaliseerde vloeroppervlakte door innovatief filter cartridge ontwerp met hoge luchtstroom
- Lagere gebruikskosten door intelligent reinigingssysteem en daardoor ook langere levensduur van de filterpatronen
- Een filtersysteem voor de toekomst dat is voorbereid op IoT - en "Insight Ready"
- Controller, HMI en gateway allemaal in één unit met het Nederman Insight bedieningspaneel

Product naam	MCP SmartFilter Ex
Filter efficiëntie (%)	99,9
Persluchtverbruik	60 liter per reinigingspuls bij 6 Bar perslucht
Installatie	Binnen, Buiten
Materiaal	Gegalvaniseerd staal
Geschikt voor explosief stof	True
Filter reinigingsmethode	Perslucht
Applicatie	Dampen, Stof
Werkdruk (kPa)	Max. vacuüm 6 kPa. Max. overdruk 0 Pa. (1,5 kPa voor silotop oplossing)
Volume opvangbak (l)	50 of 100 liter opvangbak
Filteroppervlakte (m ²)	Polyester: 30 - 192 m ²
Capaciteit (max. luchtstroom m ³)	4.500 tot 28.000

MCP SmartFilter Ex

per uur)	
Operating Temperature	-20 tot +70 graden Celsius

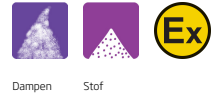

MCP SmartFilter Ex

MCP SmartFilter Ex

Product Marking of MCP SmartFilter Ex

CE  II 1D/3D/- c Ex h IIIC 120°C Da/Dc/-

Product marking of MCP SmartFilter Ex

Pred,max	KST	Zone Placement
0,3 bar	St1 (0 to 200 bar m s ⁻¹) St2 (> 200 to 300 bar m s ⁻¹) St3 (> 300 bar m s ⁻¹)*	None-zone Zone 22*

*Not available as standard, available by request

MCP SmartFilter Ex specifications

Cartridge material

- SC100 – Spunbond polyester
- SC140 – Spunbond polyester with antistatic treatment
- SC141 – Spunbond polyester with antistatic treatment and PTFE coating
- SC150 – Spunbond polyester with ePTFE membrane
- SC151 – Spunbond polyester with antistatic treatment and ePTFE membrane
- SC178/SC179 – 80% cellulose, 20% polyester material with nanofiber
- SC190 – Spunbond polyester with PTFE coating

A – Height of Clean Air Chamber (mm)

200	350	500	650
Shown in drawings	Add 150 mm in height	Add 300 mm in height	Add 450 mm in height



















MCP SmartFilter Ex

Filter area

Filter type	Quantity of cartridges	Filter area (m ²)			Max. airflow (m ³ /h)*
		SC100, SC140, SC141, SC150, SC151, SC190	SC178	SC179	
MCP-2-8S MCP-2-8S-Ex	8	48,0	105,6	52,0	7000
MCP-4-16S MCP-4-16S-Ex	16	96,0	211,2	104,0	14000
MCP-6-24S MCP-6-24S-Ex	24	144,0	316,8	156,0	21000
MCP-8-32S MCP-8-32S-Ex	32	192,0	422,4	208,0	28000
MCP-2-8SL MCP-2-8SL-Ex	8	30,4	67,2	32,8	4500
MCP-4-16SL MCP-4-16SL-Ex	16	60,8	134,4	65,6	9000
MCP-6-24SL MCP-6-24SL-Ex	24	91,2	201,6	98,4	13500
MCP-8-32SL MCP-8-32SL-Ex	32	121,6	268,8	131,2	18000

*Max. air flow is dependent on the dust type, etc.

Accessories

Figure	Description	Figure	Description
	Top mounted FM-fans 50 Hz or 60 Hz up to 14000 m ³ /h		Leg height extensions from 0 mm to 2000 mm to fit larger bins/containers, rotary valves and big bags
	Combifab remote fans 50 Hz or 60 Hz		Leg width extension 300 mm to left, right or both sides to fit larger bins/containers, rotary valves and big bags
	Noise enclosure to reduce fan and motor break-out-noise of FM-fans		Suspension below rotary valve for big bag
	Dual silencer to reduce air flow, fan noise and motor break-out-noise of FM-fans (available with grid (indoor use), grid and rain cover (outdoor use) or flange for duct connection)		Isolation box for pressure tank incl. cleaning valves
	Regulation (iris) damper at fan inlet for FM-fans		Access platform with ladder for maintenance
	Dust bins (50 l, 50 l with wheels and 100 l with wheels)		Lime feeder NFKG-70
	Plastic bag in the dust bin with pressure compensation set 'bin balancing'		Several sensors available for extraction, filtration and discharge process
	Rotary valves NRS3 and NRSZ3		Water separator and pressure regulator
	Dust discharge valve NFUS3		QF-duct system

MCP SmartFilter Ex

MCP-2-8S / MCP-2-8S-Ex
MCP-2-8SL / MCP-2-8SL-Ex

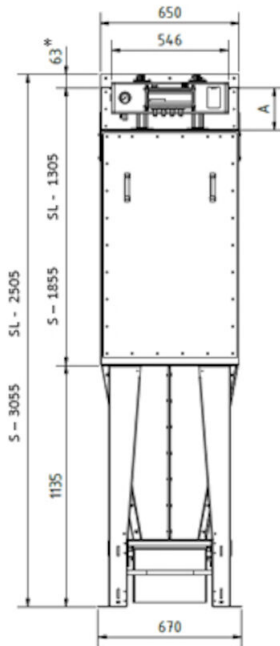

All dimensions in mm.

If 50 liter bin with wheels 90 mm must be added to the height.

* to be included only if a top mounted FM fan is used (transition for fan).

MCP SmartFilter Ex

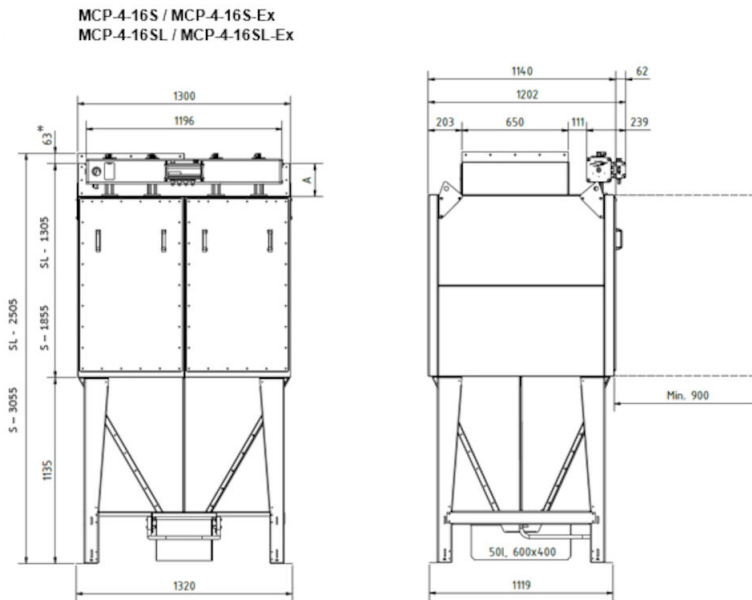

All dimensions in mm.

If 50 liter bin with wheels 90 mm must be added to the height.

* to be included only if a top mounted FM fan is used (transition for fan).

MCP SmartFilter Ex

MCP-6-24S / MCP-6-24S-Ex
MCP-6-24SL / MCP-6-24SL-Ex



All dimensions in mm.

If 50 liter bin with wheels 90 mm must be added to the height.

* to be included only if a top mounted FM fan is used (transition for fan).

MCP SmartFilter Ex

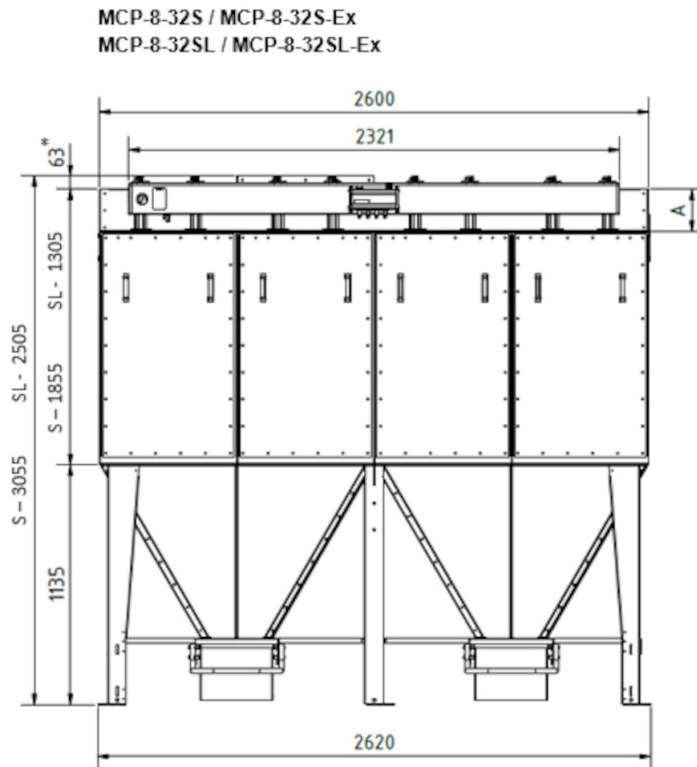

All dimensions in mm.

If 50 liter bin with wheels 90 mm must be added to the height.

* to be included only if a top mounted FM fan is used (transition for fan).