

# MEP SmartFilter Ex (FMKZ)

Mehrzweck-Kassettenfilter hauptsächlich für Außeninstallationen kann für viele verschiedene Industriezweige wie Metallverarbeitung, Lebensmittel und Pharmazie, Chemie, Mineralien, Recycling und Explosionsgefährliche Stäube wie Verbundwerkstoffe, Holz und viele andere Industrien verwendet werden.

---

## MEP SmartFilter Ex (FMKZ)



MEP SmartFilter ist ein Mehrzweck-Filtrationssystem. Es kann an die kundenspezifischen Anforderungen angepasst werden. Es eignet sich für Rauch und Staub und kann in verschiedenen Anwendungen wie Schweißen, Metallschneiden und allgemeinem Staub eingesetzt werden.

Das modulare Design ermöglicht sowohl Einzelplatzlösungen als auch Multifilterlösungen für erweiterte Anforderungen. Der MEP nutzt unterschiedliche und bewährte Filtermaterialien, welche einfach und schnell über die vorderen Wartungstüren gewartet werden können.

Die Konstruktion aus 2 mm verzinkten Stahlpaneelen ermöglicht eine einfache Installation, einen kostengünstigen Versand und bietet Korrosionsschutz. Das Design ist auf eine lange Filterlebensdauer optimiert und bietet niedrige Betriebskosten.

Die Insight-Ready-Steuerung mit fortschrittlicher Impulsreinigungslogik sorgt für einen vollständigen Systembetrieb einschließlich Steuerung und Überwachung sowie Gateway-Funktionalität für die Cloud-Kommunikation.

Es ist vollständig konform zu gängigen global-anerkannten Richtlinien, insbesondere für explosive Stäube (ATEX). Der MCP SmartFilter verfügt über ein umfangreiches Zubehörprogramm, darunter Ventilatoren, Sensoren, Einlässe, Behälter usw., und die Patronen sind in einer Vielzahl von Materialien erhältlich.

- Gewinnen Sie mit Insight Analytics die Kontrolle über die Filterleistung. Nederman's einzigartige Überwachungstechnologie
- Optimierte Stellfläche durch innovatives Patronendesign mit hohem Luftdurchsatz
- Reduzierte Gesamtkosten durch intelligentes Reinigungssystem, lange Filterpatronen-Lebensdauer und optimierte Stellfläche
- Fortschrittliche Steuerung, die für IoT-Anwendungen vorbereitet ist - Insight Ready
- Controller, HMI und Gateway in einer Einheit mit dem Insight Control Panel.

Produktname	MEP SmartFilter Ex (FMKZ)
Druckluftverbrauch	58 Liter pro Reinigungsimpuls bei 6,0 bar Druckluft
Installation	im Gebäude, im Freien
Material	Verzinkter Stahl
Geeignet für explosionsfähigen Staub	True
Filterreinigungsmethode	Impulsstrahl
Applikation	Rauche, Stäube
Max. Arbeitsdruck (kPa)	Unterdruck max. 6 kPa. Überdruck max. 0 Pa. (1,5 kPa für Silotop-Lösung)

## MEP SmartFilter Ex (FMKZ)

Volumen Staubbehälter (l)	50 oder 100 Liter Behälter
Filterfläche (m <sup>2</sup> )	15-88
Kapazität (Max Volumenstrom m <sup>3</sup> /h)	1800 - 10500
Betriebstemperatur	-20 bis +70 Grad C.
Filtertyp	Kassettenfilter
Filtermaterial	Je nach Anwendung











Rauche



Stäube











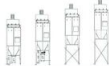



## MEP SmartFilter Ex (FMKZ)

Bild	Beschreibung	Anzahl der Filter	Modell
	MEP-4-4-Ex Smartfilter	4	MEP-4-4-Ex
	MEP-6-4-Ex Smartfilter	6	MEP-6-4-Ex
	MEP-8-4-Ex Smartfilter	8	MEP-8-4-Ex
	MEP-2-6-Ex Smartfilter	2	MEP-2-6-Ex
	MEP-4-6-Ex Smartfilter	4	MEP-4-6-Ex
	MEP-6-6-Ex Smartfilter	6	MEP-6-6-Ex
	MEP-8-6-Ex Smartfilter	8	MEP-8-6-Ex
	MEP-2-4-Ex SmartFilter	2	MEP-2-4-Ex

## MEP SmartFilter Ex (FMKZ)

### Accessories

Figure	Description	Figure	Description
	Top mounted FM-fans 50 Hz or 60 Hz up to 14000 m³/h		Leg height extensions from 0 mm to 2000 mm to fit larger bins/containers, rotary valves and big bags
	Combifab remote fans 50 Hz or 60 Hz		Leg width extension 300 mm to left, right or both sides to fit larger bins/containers, rotary valves and big bags
	Noise enclosure to reduce fan and motor break-out-noise of FM-fans		Suspension below rotary valve for big bag
	Dual silencer to reduce air flow, fan noise and motor break-out-noise of FM-fans (available with grid (indoor use), grid and rain cover (outdoor use) or flange for duct connection)		Isolation box for pressure tank incl. cleaning valves
	Regulation (iris) damper at fan inlet for FM-fans		Access platform with ladder for maintenance
	Dust bins (50 l, 50 l with wheels and 100 l with wheels)		Lime feeder NFKG-70
	Plastic bag in the dust bin with pressure compensation set 'bin balancing'		Several sensors available for extraction, filtration and discharge process
	Rotary valves NRS3 and NRSZ3		Water separator and pressure regulator
	Dust discharge valve NFUS3		QF-duct system

### Envelope material

- NF100 – Polyester needlefelt, singed, 500 g/m<sup>2</sup>
- NF130 – Polyester needlefelt, glazed, 500 g/m<sup>2</sup>
- NF141 – Polyester needlefelt, glazed, 400 g/m<sup>2</sup>, antistatic
- NF142 – Polyester needlefelt, glazed, 500 g/m<sup>2</sup>, antistatic
- NF143 – Polyester needlefelt, PTFE coating, 550 g/m<sup>2</sup>, antistatic
- NF180 – Polyester needlefelt, glazed, 550 g/m<sup>2</sup>
- NF181 – Polyester needlefelt, PTFE coating, 550 g/m<sup>2</sup>

MCP Envelope material

## MEP SmartFilter Ex (FMKZ)

A – Height of Clean Air Chamber (mm)			
200	350	500	650
Shown in drawings	Add 150 mm in height	Add 300 mm in height	Add 450 mm in height

MEP A - height of clean air chamber

### Product Marking of MEP SmartFilter Ex



 II 1D/3D/- c Ex h IIC 120°C Da/Dc/-

MEP SmartFilter Ex marking

Pred.max	KST	Zone Placement
0,3 bar	S11 (0 to 200 bar m s <sup>-1</sup> ) S12 (> 200 to 300 bar m s <sup>-1</sup> ) S13 (> 300 bar m s <sup>-1</sup> )*	None-zone Zone 22*

\*Not available as standard, available by request

MEP SmartFilter Ex specifications

#### Filter area

Filter type	Quantity of envelopes	Filter area (m <sup>2</sup> )	Max. airflow (m <sup>3</sup> /h)*
MEP-2-4 MEP-2-4-Ex	2	15	1800
MEP-4-4 MEP-4-4-Ex	4	29	3400
MEP-6-4 MEP-6-4-Ex	6	44	5200
MEP-8-4 MEP-8-4-Ex	8	58	7000
MEP-2-6 MEP-2-6-Ex	2	22	2600
MEP-4-6 MEP-4-6-Ex	4	44	5200
MEP-6-6 MEP-6-6-Ex	6	66	8000
MEP-8-6 MEP-8-6-Ex	8	88	10500

\*Max. air flow is dependent on the dust type, etc.

MEP Filter area

## MEP SmartFilter Ex (FMKZ)

MEP-2.4 / MEP-2.4-Ex  
MEP-2.6 / MEP-2.6-Ex

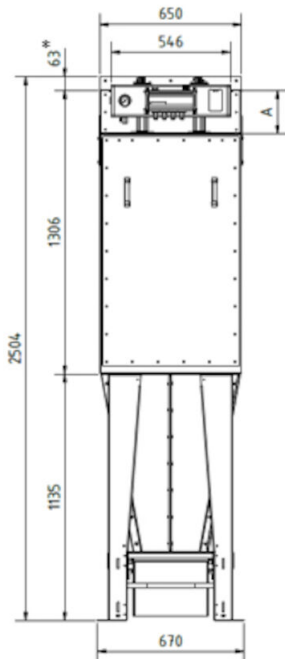

All dimensions in mm.

If 50 liter bin with wheels 90 mm must be added to the height.

\* to be included only if a top mounted FM fan is used (transition for fan).

## MEP SmartFilter Ex (FMKZ)

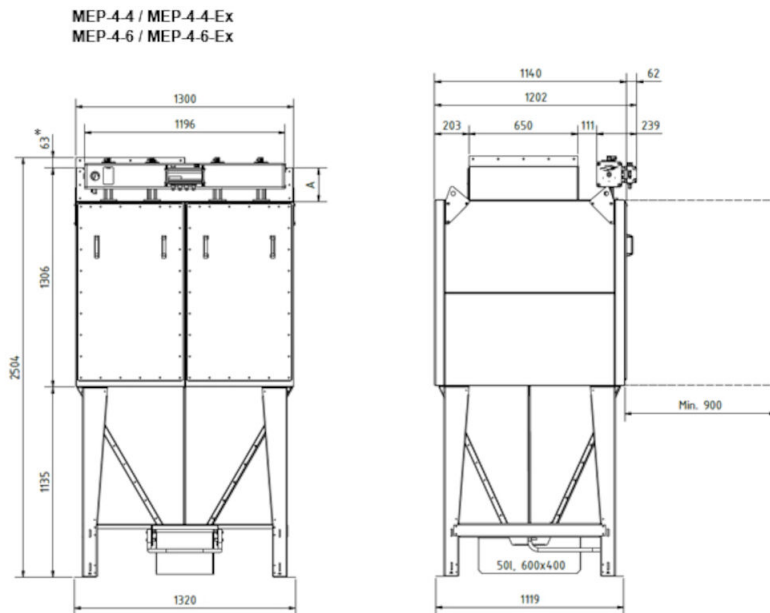

All dimensions in mm.

If 50 liter bin with wheels 90 mm must be added to the height.

\* to be included only if a top mounted FM fan is used (transition for fan).



## MEP SmartFilter Ex (FMKZ)

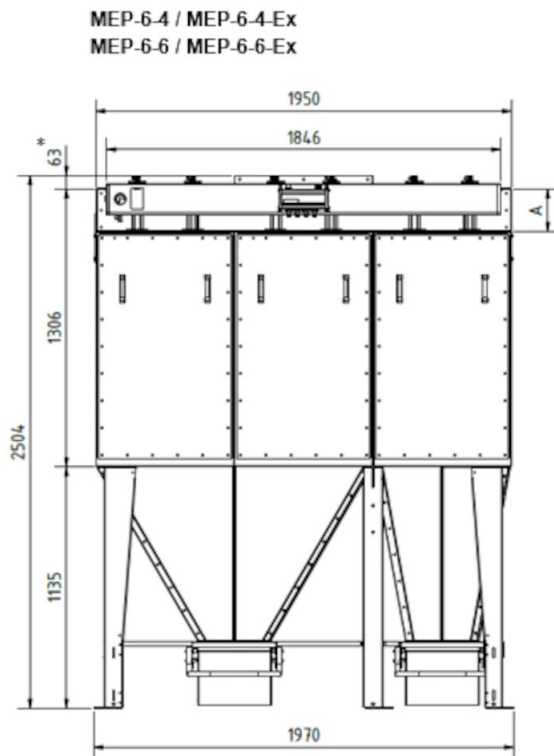

All dimensions in mm.

If 50 liter bin with wheels 90 mm must be added to the height.

\* to be included only if a top mounted FM fan is used (transition for fan).

## MEP SmartFilter Ex (FMKZ)

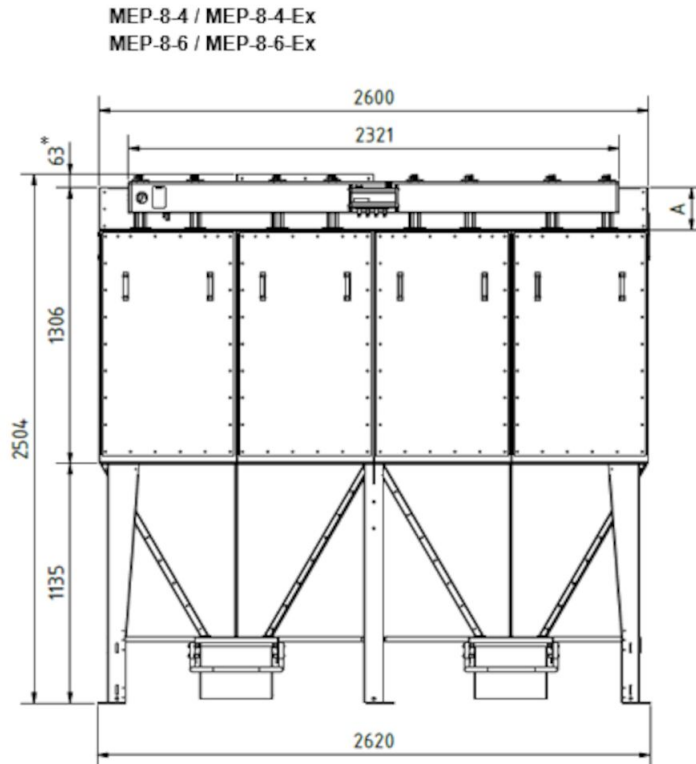

All dimensions in mm.

If 50 liter bin with wheels 90 mm must be added to the height.

\* to be included only if a top mounted FM fan is used (transition for fan).