

## Explosion Isolation Flap Valve CARZ-N Ø315-1000mm

Explosion Isolation Flap Valve CARZ-N - protective system for combustible dust applications



Explosion Isolation Flap Valve type CARZ-N prevents a transmission of explosion pressure wave and flames front from the filter to your workplace. By using our CARZ-N Explosion Isolation Flap Valve, you reduce the risk from dust explosion for both people and equipment.

### Function

During normal operation, the valve is kept open, and large opening angle ensure low pressure drop. In case of an explosion in the filter, the pressure wave will force to close the flap plate and lock in position. When flap plate is closed it makes an effective barrier against approaching flame front. This prevent the explosion from being transmitted from the filter to upstream work areas.

No matter what industry you are in or what type of dust is generated in your factory, we can provide the complete dust explosion protection solution of filters, and explosion isolation flap valves.

- Independently tested to latest and most stringent standards and regulations
- Compliant with international dust explosion protection codes (ATEX, NFPA68, IECEx)
- Widest range of sizes, applications and filter system configurations on the market (e.g. approval for positive and negative pressure systems, approval for St2 dusts up to size 630 inclusive)
- Manufactured fully by Nederman under certified quality assurance system, ensuring highest level of quality and reliability







<b>Product name</b>	Explosion Isolation Flap Valve CARZ-N Ø315-1000mm
<b>Material</b>	Welded carbon steel, painted RAL5009
<b>Operating temperature range</b>	-20 - +70°C (0 - 160F)
<b>Ambient temperature range</b>	-20 - +60°C (0 - 140F)
<b>Note</b>	LEL = Lower Explosion Limit = MEC Minimum Explosion Concentration
<b>Max velocity in duct (m/s)</b>	30
<b>Minimum velocity in duct</b>	0
<b>Install type</b>	Push and Pull



# Explosion Isolation Flap Valve CARZ-N Ø315-1000mm





















[Image]	Diameter (mm)	Connection	Weight (kg)	Explosion Class ATEX	Dust Concentration in duct	Minimum vessel size, push (m3)	Minimum vessel size, pull (m3)	Kst (bar m/s)	Maximum reduced pressure, Pred (bar)	[model]
	450	FL	175	St2	ST1: Any; ST2: < LEL	1,6	0,9	300	ST1: 0,5 bar; ST2: 0,4 bar	73007816*
	450	NW	175	St2	ST1: Any; ST2: < LEL	1,6	0,9	300	ST1: 0,5 bar; ST2: 0,4 bar	73007817*
	500	FL	200	St2	ST1: Any; ST2: < LEL	1,6	1,6	300	ST1: 0,5 bar; ST2: 0,4 bar	73007839*
	500	NW	200	St2	ST1: Any; ST2: < LEL	1,6	1,6	300	ST1: 0,5 bar; ST2: 0,4 bar	73007840*
	560	FL	224	St2	ST1: Any; ST2: < LEL	1,6	1,6	300	ST1: 0,5 bar; ST2: 0,4 bar	73007845*
	560	NW	224	St2	ST1: Any; ST2: < LEL	1,6	1,6	300	ST1: 0,5 bar; ST2: 0,4 bar	73007846*
	630	FL	260	St2	ST1: Any; ST2: < LEL	1,6	1,6	300	ST1: 0,5 bar; ST2: 0,4 bar	73007851*
	630	NW	260	St2	ST1: Any; ST2: < LEL	1,6	1,6	300	ST1: 0,5 bar; ST2: 0,4 bar	73007852*
	710	FL		St1	Any	3,2	3,2	200	PULL: 0,35 bar; PUSH: 0,4 bar	73008055
	710	NW	566	St1	Any	3,2	3,2	200	PULL: 0,35 bar; PUSH: 0,4 bar	73008056
	800	FL	431	St1	Any	3,2	3,2	200	PULL: 0,35 bar; PUSH: 0,4 bar	73008058
	800	NW	431	St1	Any	3,2	3,2	200	PULL: 0,35 bar; PUSH: 0,4 bar	73008059
	900	FL	490	St1	Any	3,2	3,2	200	PULL: 0,35 bar; PUSH: 0,4 bar	73008060
	900	NW	490	St1	Any	3,2	3,2	200	PULL: 0,35 bar; PUSH: 0,4 bar	73008061
	1000	FL	566	St1	Any	3,2	3,2	200	PULL: 0,35 bar; PUSH: 0,4 bar	73008062

## Explosion Isolation Flap Valve CARZ-N Ø315-1000mm







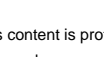

[Image]	Diameter (mm)	Connection	Weight (kg)	Explosion Class ATEX	Dust Concentration in duct	Minimum vessel size, push (m3)	Minimum vessel size, pull (m3)	Kst (bar m/s)	Maximum reduced pressure, Pred (bar)	[model]
	1000	NW	566	St1	Any	3,2	3,2	200	PULL: 0,35 bar; PUSH: 0,4 bar	73008063
	315	FL		St2	Any	0,46	0,46	300	0,5	73008407
	315	NW		St2	Any	0,46	0,46	300	0,5	73008408
	350	FL		St2	ST1: Any; ST2: < LEL	1,6	0,9	300	ST1: 0,5 bar; ST2: 0,4 bar	73008409*
	350	NW		St2	ST1: Any; ST2: < LEL	1,6	0,9	300	ST1: 0,5 bar; ST2: 0,4 bar	73008410*
	400	FL		St2	ST1: Any; ST2: < LEL	1,6	0,9	300	ST1: 0,5 bar; ST2: 0,4 bar	73008411*
	400	NW		St2	ST1: Any; ST2: < LEL	1,6	0,9	300	ST1: 0,5 bar; ST2: 0,4 bar	73008412*
	315	QF		St2	Any	0,46	0,46	300	0,5	73008413
	350	QF		St2	ST1: Any; ST2: < LEL	1,6	0,9	300	ST1: 0,5 bar; ST2: 0,4 bar	73008414*
	400	QF		St2	ST1: Any; ST2: < LEL	1,6	0,9	300	ST1: 0,5 bar; ST2: 0,4 bar	73008415*

\*LEL = Lower Explosion Limit = MEC Minimum Explosion Concentration

## Explosion Isolation Flap Valve CARZ-N Ø315-1000mm

	[accessory]	[partno]
	CARZ support frame suspended 160	73001558
	CARZ support frame suspended 180	73001559
	CARZ support frame suspended 200	73001560
	CARZ support frame suspended 250	73001561
	CARZ support frame suspended 315	73001562
	CARZ support frame suspended 350	73001563
	CARZ support frame suspended 400	73001564
	CARZ support frame suspended 450	73001565
	CARZ support frame suspended 500	73001566
	CARZ support frame suspended 600	73001567
	CARZ support frame suspended 710	73001568
	CARZ support frame suspended 800	73001569
	CARZ support frame suspended 900	73001570
	Carz support frame suspended 1000	73001571
	CARZ support frame suspended 1000	73001572
	CARZ support frame wall-hanging 160	73001573
	CARZ support frame wall-hanging 180	73001574
	CARZ support frame wall-hanging 200	73001575
	CARZ support frame wall-hanging 250	73001576
	CARZ support frame wall-hanging 315	73001577
	CARZ support frame wall-hanging 350	73001578
	CARZ support frame wall-hanging 400	73001579

## Explosion Isolation Flap Valve CARZ-N Ø315-1000mm

	[accessory]	[partno]
	CARZ support frame wall-hanging 450	73001580
	CARZ support frame wall-hanging 500	73001581
	CARZ support frame wall-hanging 560	73001582
	CARZ support frame wall-hanging 630	73001583
	CARZ support frame wall-hanging 710	73001584
	CARZ support frame wall-hanging 800	73001585
	CARZ support frame wall-hanging 900	73001586
	CARZ support frame wall-hanging 1000	73001587

# Explosion Isolation Flap Valve CARZ-N Ø315-1000mm

Suction direction

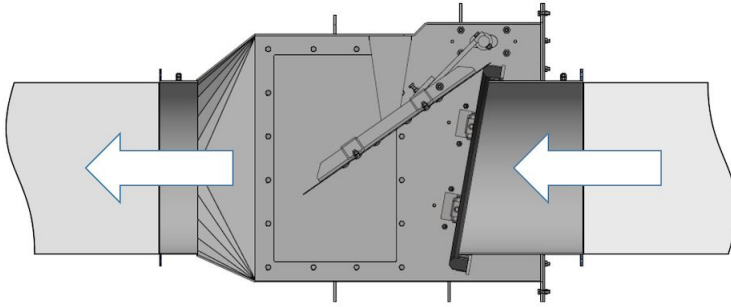

Suction direction

Explosion direction

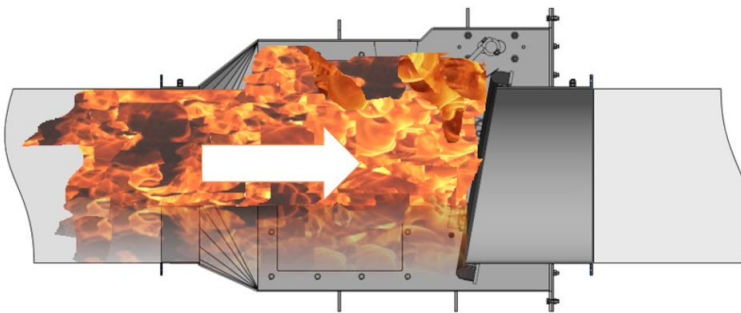

Explosion direction

## Explosion Isolation Flap Valve CARZ-N Ø315-1000mm

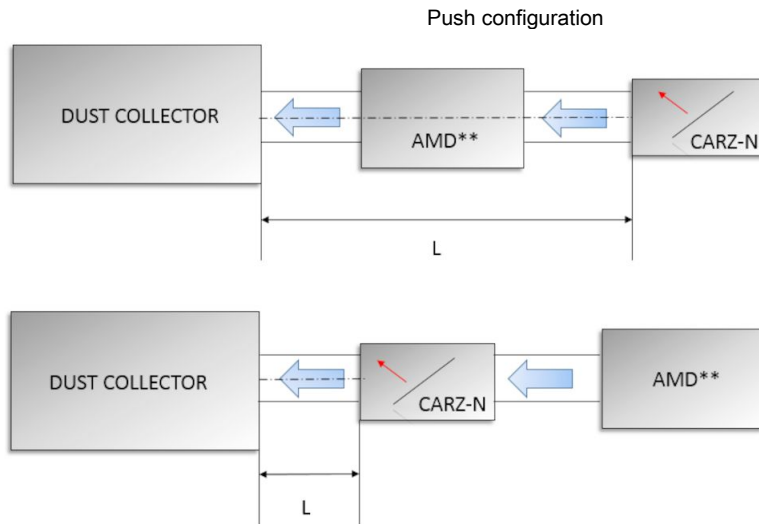

\*\*AMD = Air Moving Device or fan  
L = For min and max ducting lengths, see specific part numbers

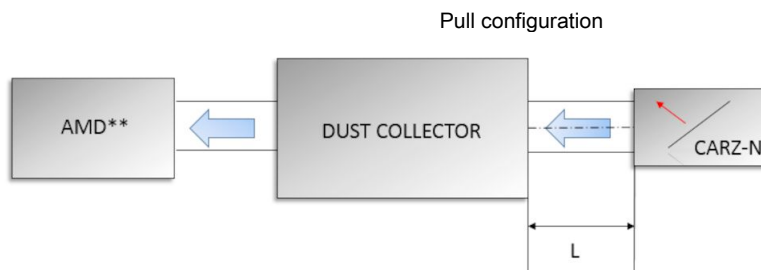

\*\*AMD = Air Moving Device or fan  
L = For min and max ducting lengths, see specific part numbers