

Vanne d'isolation CARZ-N Ø315-1000mm

Vanne clapet anti-retour CARZ-N - Système de protection pour vos applications avec poussières combustibles.



La vanne d'isolation CARZ-N empêche la transmission des ondes de pression d'explosion et des flammes du dépoussiéreur à votre lieu de travail. En utilisant notre clapet anti-explosion CARZ, vous réduisez le risque d'explosion de poussières et ainsi le danger pour les personnes et l'équipement.

Fonction















Pendant le fonctionnement normal, la vanne est maintenue ouverte et un grand angle d'ouverture garantit une faible chute de pression. En cas d'explosion dans le dépoussiéreur, l'onde de pression forcera la fermeture de la plaque du volet et le verrouillage en position. Lorsque la plaque à rabat est fermée, elle constitue une barrière efficace contre l'approche du front de flamme. Cela empêche la transmission de l'explosion du filtre aux zones de travail en amont. Peu importe l'industrie dans laquelle vous vous trouvez ou le type de poussière généré, nous pouvons fournir la solution complète de protection contre les explosions de poussière.

- Testé par un organisme indépendant selon les normes et réglementations les plus récentes et les plus strictes
- Conforme aux codes internationaux de protection contre les explosions de poussières (ATEX, NFPA69, IECEx)
- La plus large gamme de tailles, d'applications et de configurations de systèmes de dépoussiérage sur le marché (par exemple, approbation pour les systèmes à pression positive et négative, approbation pour les poussières St2 jusqu'à la taille 630 inclus)
- Fabriqué entièrement par Nederman sous un système d'assurance Qualité certifié, garantissant le plus haut niveau de qualité et de fiabilité











Nom du produit	Vanne d'isolation CARZ-N Ø315-1000mm
Matériel	Construction soudée en tôle d'acier peinte en bleu RAL 5009.
Operating temperature range	-20 - +70°C (0 - 160F)
Ambient temperature range	-20 - +60°C (0 - 140F)
Note	LEL = Lower Explosion Limit = MEC Minimum Explosion Concentration
Max velocity in duct (m/s)	30
Minimum velocity in duct	0
Install type	Push and Pull



Vanne d'isolation CARZ-N Ø315-1000mm





















[image]	Diamètre (mm)	Connection	Poids (kg)	Explosion Class ATEX	Dust Concentration in duct	Minimum vessel size, push (m ³)	Minimum vessel size, pull (m ³)	Dust type	Kst (bar m/s)	Maximum reduced pressure, Pred (bar)	[model]
	450	FL	175	St2	ST1: Any; ST2: < LEL	1,6	0,9		300	ST1: 0,5 bar; ST2: 0,4 bar	73007816*
	450	NW	175	St2	ST1: Any; ST2: < LEL	1,6	0,9		300	ST1: 0,5 bar; ST2: 0,4 bar	73007817*
	500	FL	200	St2	ST1: Any; ST2: < LEL	1,6	1,6		300	ST1: 0,5 bar; ST2: 0,4 bar	73007839*
	500	NW	200	St2	ST1: Any; ST2: < LEL	1,6	1,6		300	ST1: 0,5 bar; ST2: 0,4 bar	73007840*
	560	FL	224	St2	ST1: Any; ST2: < LEL	1,6	1,6		300	ST1: 0,5 bar; ST2: 0,4 bar	73007845*
	560	NW	224	St2	ST1: Any; ST2: < LEL	1,6	1,6		300	ST1: 0,5 bar; ST2: 0,4 bar	73007846*
	630	FL	260	St2	ST1: Any; ST2: < LEL	1,6	1,6		300	ST1: 0,5 bar; ST2: 0,4 bar	73007851*
	630	NW	260	St2	ST1: Any; ST2: < LEL	1,6	1,6		300	ST1: 0,5 bar; ST2: 0,4 bar	73007852*
	710	FL		St1	Any	3,2	3,2		200	PULL: 0,35 bar; PUSH: 0,4 bar	73008055
	710	NW	566	St1	Any	3,2	3,2		200	PULL: 0,35 bar; PUSH: 0,4 bar	73008056
	800	FL	431	St1	Any	3,2	3,2		200	PULL: 0,35 bar; PUSH: 0,4 bar	73008058
	800	NW	431	St1	Any	3,2	3,2		200	PULL: 0,35 bar; PUSH: 0,4 bar	73008059
	900	FL	490	St1	Any	3,2	3,2		200	PULL: 0,35 bar; PUSH: 0,4 bar	73008060
	900	NW	490	St1	Any	3,2	3,2		200	PULL: 0,35 bar; PUSH: 0,4 bar	73008061
	1000	FL	566	St1	Any	3,2	3,2		200	PULL: 0,35 bar; PUSH: 0,4 bar	73008062

Vanne d'isolation CARZ-N Ø315-1000mm

[image]	Diamètre (mm)	Connection	Poids (kg)	Explosion Class ATEX	Dust Concentration in duct	Minimum vessel size, push (m ³)	Minimum vessel size, pull (m ³)	Dust type	Kst (bar m/s)	Maximum reduced pressure, Pred (bar)	[model]
	1000	NW	566	St1	Any	3,2	3,2		200	PULL: 0,35 bar; PUSH: 0,4 bar	73008063
	315	FL		St2	Any	0,46	0,46		300	0,5	73008407
	315	NW		St2	Any	0,46	0,46		300	0,5	73008408
	350	FL		St2	ST1: Any; ST2: < LEL	1,6	0,9		300	ST1: 0,5 bar; ST2: 0,4 bar	73008409*
	350	NW		St2	ST1: Any; ST2: < LEL	1,6	0,9		300	ST1: 0,5 bar; ST2: 0,4 bar	73008410*
	400	FL		St2	ST1: Any; ST2: < LEL	1,6	0,9		300	ST1: 0,5 bar; ST2: 0,4 bar	73008411*
	400	NW		St2	ST1: Any; ST2: < LEL	1,6	0,9		300	ST1: 0,5 bar; ST2: 0,4 bar	73008412*
	315	QF		St2	Any	0,46	0,46		300	0,5	73008413
	350	QF		St2	ST1: Any; ST2: < LEL	1,6	0,9		300	ST1: 0,5 bar; ST2: 0,4 bar	73008414*
	400	QF		St2	ST1: Any; ST2: < LEL	1,6	0,9		300	ST1: 0,5 bar; ST2: 0,4 bar	73008415*

*LEL = Lower Explosion Limit = MEC Minimum Explosion Concentration

Vanne d'isolation CARZ-N Ø315-1000mm

	[accessory]	[partno]
	CARZ support frame suspended 160	73001558
	CARZ support frame suspended 180	73001559
	CARZ support frame suspended 200	73001560
	CARZ support frame suspended 315	73001562
	CARZ support frame suspended 500	73001566
	CARZ support frame suspended 710	73001569
	Carz support frame suspended 900	73001571
	CARZ support frame suspended 1000	73001572
	CARZ support frame wall-hanging 160	73001573
	CARZ support frame wall-hanging 180	73001574
	CARZ support frame wall-hanging 200	73001575
	CARZ support frame wall-hanging 250	73001576
	CARZ support frame wall-hanging 315	73001577
	CARZ support frame wall-hanging 350	73001578
	CARZ support frame wall-hanging 400	73001579
	CARZ support frame wall-hanging 450	73001580
	CARZ support frame wall-hanging 500	73001581
	CARZ support frame wall-hanging 560	73001582
	CARZ support frame wall-hanging 900	73001586
	CARZ support frame wall-hanging 1000	73001587

Vanne d'isolation CARZ-N Ø315-1000mm

Special installation requirements

PULL configuration



PUSH configuration

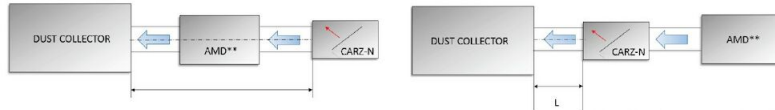

**AMD=Air moving device or fan

Parameter	Dust type	Size 315 mm	Size 350 - 450 mm	Size 500 - 1000 mm
L min	Organic	5 m (16.4 ft) for PULL & PUSH	5,5 m (18 ft) for PULL 5 m (16.4 ft) for PUSH	5,5 m (18 ft) for PULL 5 m (16.4 ft) for PUSH
	Metallic	5,3 m (17.4 ft) only for PULL	5,5 m (18 ft) only for PULL	N/A
L max	Organic	10,2 m (33.5 ft) for PULL 10 m (32.8 ft) for PUSH	10 m (32.8 ft) for PULL & PUSH	10 m (32.8 ft) for PULL & PUSH
	Metallic	10,3 m (33.8 ft) only for PULL	10,5 m (34.5 ft) only for PULL	N/A
Max. flow velocity		30 m · s ⁻¹ (5,906 fpm)		
Max. number of bends (between CARZ-N and protected vessel)		straight duct with max. 2 bends 90 dgr		

AMD**=Air moving device or fan

L=for min and max ducting lengths, see specific part numbers.

Suction direction

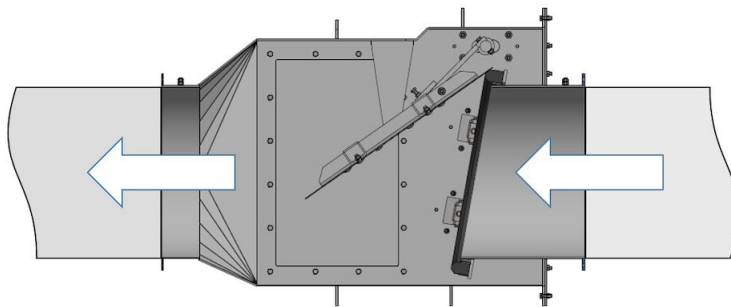

Suction direction

Vanne d'isolation CARZ-N Ø315-1000mm

