

## FilterBox 12M

Manually cleaned for heavier dust & fume applications.



The FilterBox 12M is equipped with a powerful fan for a maximum air flow capacity of 1 200 m<sup>3</sup>/h (700 CFM). An integrated silencer reduces noise from the fan and outlet air.

The filter cartridge is manually cleaned. There is an alarm indicating when the air flow is too low, as well as an operating hours meter.

The unit is available either as a mobile unit on wheels or attached to a floor stand. Additional protection from harmful particles is provided if a HEPA filter is installed.

For dust applications, the unit is cleaned mechanically. For welding fumes it uses a combination of mechanical and compressed air cleaning.

For welding applications, compressed air cleaning is required.





Note! FilterBox is not for use in environments where combustible dust or gases are present, and it is not for use in filtering combustible dust or gases.

- User friendly and superior filter cleaning, mechanical and/or with compressed air for long filter life
- Automatic damper preventing dust from leaking out while cleaning
- Dust free filter replacement and emptying of dust bin
- Third party approval for welding fumes category W3 according to EN 15012-1
- Approved for welding fumes category W3 according to EN 15012-1, third party tested.











Product name	FilterBox 12M
Noise level (dB(A))	74
Protection class	IP 54
Filter efficiency (%)	99
Compressed air requirement	DIN ISO 8573-1, class 5/5/4 (7 bar)
Installation	[Indoor]
Material	Casing in rotomoulded plastic
Dustbin volume (l)	15
Extraction arm diameter (mm)	160
Airflow (m <sup>3</sup> /h)	1200
Filter Area (m <sup>2</sup> )	13
Frequency (Hz)	50
No of phases	3
Filter type	[cartridge]
Number of filter elements	1
Filter material	Polyester PW13
Electric plug	[without]
Filter cleaning method	[Mechanical], [CompressedAir]
Power (kW)	2,2

# FilterBox 12M

## FilterBox 12M

[image]	Description	Power Voltage (V)	Arm length (m)	Mounting	Weight (kg)	[model]
	FilterBox 12M	230	3 (Original)		115	12660363
	FilterBox 12M	230	3 (Original)		112	12660463
	FilterBox 12M	400	3 (Original)		112	12660663
	FilterBox 12M	400	3 (Original)		115	12660563
	FilterBox 12M	200	3 (Original)		115	12660763
	FilterBox 12M.	400	Without		115	12686963
	FilterBox 12M.	400	Without		112	12685163

## FilterBox 12M

	[accessory]	[partno]
	Spotlight original, (LED) 24V, 5W	12376616*
	Handle eQ Filterbox	12376617
	Outlet with duct connection D=200mm	12376749
	Spark protection for Original/NEX MD-hood	10551335
	Filter-PW-FB-13	12332672
	Filter-PW HE-FB-15	12371106
	Filter PWA-FB-15	12371412
	HEPA filter H13 10m2 Filterbox	12376615
	HEPA filter H14 10m2 Filterbox	12376756
	Bags for Filterbox dust bin, 10pcs	12376618
	Twin Module blue	12376801
	Filter PTFE-FB-13	12377252

\*Switch for light (no fan start)

## FilterBox 12M

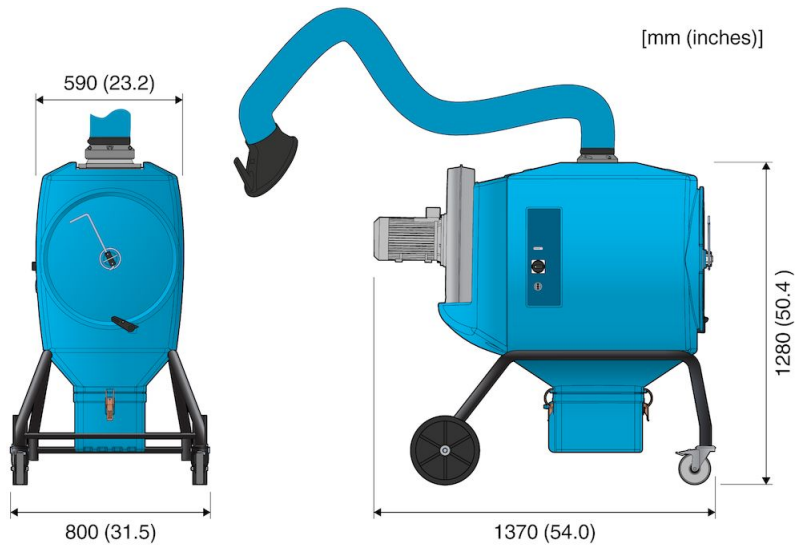

FilterBox 12M. Mobile

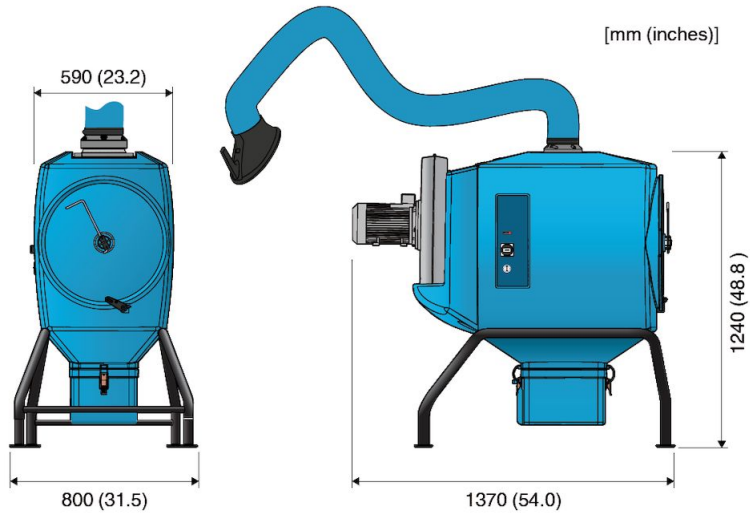

Floor mounted FilterBox 12M