

NOM 11

Oil mist filter



Designed for lathing and milling applications, for machines stamping and pressing steel plates, industrial washing machines, abrasive water jets etc. In all metal fabrication with oil mist troubles, these filters will fit into a ducting system, connected to each machine. All units are equipped with pressure gauge for control of filters as well as a indication for need of cleaning (self draining). Suitable for emulsion mist.

- Low maintenance cost
- Self draining mist filter
- Easy to install
- High filtration efficiency
- Made to take up very little space with integrated fan for most models

Product name	NOM 11
Noise level (dB(A))	66,4
Protection class	IP 55
Filter efficiency (%)	97,5
Compressed air requirement	No
Compressed air consumption	No
Installation	Indoor
Material	Housing made in oil resistant wet painted sheet metal.
Suitable for combustible dust	False
Material recycling (% weight)	86
Filter Area (m ²)	8,5
Capacity (max airflow m ³ /h)	1100
Operating Temperature	5 - 60 C
Filter type	Cartridge
Number of filter elements	1
Filter material	Glassfibre/Polyester
Power (kW)	0,75



NOM 11







Description	Power Voltage (V)	Frequency (Hz)	No of phases	Amperage (A)	Weight (kg)	Model
NOM 11	230	50	1	5,7	148	12621768
NOM 11, HEPA	400/230	50	3	1,7/2,9	153	12622268*
NOM 11 (without fan)					136	12622668**
NOM 11 (without fan)					131	12622568***
NOM 11	230	50	1	5,7	153	12621868*
NOM 11	400/230	50	3	1,7/2,9	148	12622168
NOM 11	380	60	3	1,73 / 3,0	153	12623368*

*Includes HEPA filter with 16 sqm filterarea and with 99,97 % efficiency.

**Delivered without fan. Includes HEPA filter with 16 sqm filterarea and with 99,97 % efficiency.

***Delivered without Fan.

NOM 11

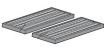
Accessory		Part No
	FMS 1.6-2.5 Fan Manual Starter incl. motor protector 1.6-2.5A	14502237
	Silencer NOM 11	12373649
	Container NOM 11, 18, 28	12373651
	Hose with oil trap NOM	12373652
	Main filter 8,5m2 NOM 11	12373654
	HEPA 16m2 NOM 11	12373646
	Coarse pre-filter	12376294

NOM 11



Y = Efficiency (%), X = Particle size (µm)

A = NOM filter, B = Centrifugal filter A, C = Centrifugal filter B

Efficiency of NOM main filter compared to typical centrifugal filters, tested with DOP.

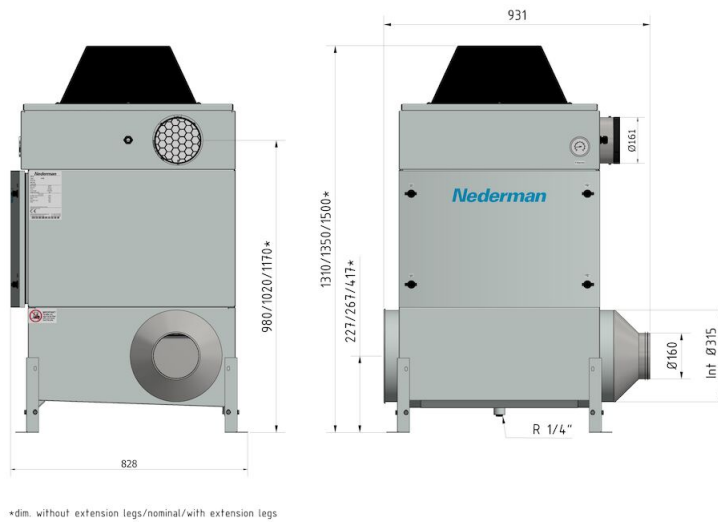

*dim. without extension legs/nominal/with extension legs

NOM 11

