

## NOM 18

### Oil mist filter



Designed for lathing and milling applications, for machines stamping and pressing steel plates, industrial washing machines, abrasive water jets etc. In all metal fabrication with oil mist troubles, these filters will fit into a ducting system, connected to each machine. All units are equipped with pressure gauge for control of filters as well as an indication for need of cleaning (self draining). Suitable for emulsion mist.

- Low maintenance cost
- Self draining mist filter
- Easy to install
- High filtration efficiency
- Made to take up very little space with integrated fan for most models..

Product name	NOM 18
Noise level (dB(A))	63,8
Protection class	IP 55
Filter efficiency (%)	97,5
Compressed air requirement	No
Compressed air consumption	No
Installation	[Indoor]
Material	Housing made in oil resistant wet painted sheet metal.
Suitable for combustible dust	False
Material recycling (% weight)	90
Filter Area (m <sup>2</sup> )	14
Capacity (max airflow m <sup>3</sup> /h)	1800
Operating Temperature	5 - 60 C
Filter type	[cartridge]
Number of filter elements	2
Filter material	Glassfibre/Polyester
Power (kW)	1,1



## NOM 18









Description	Power Voltage (V)	Frequency (Hz)	No of phases	Amperage (A)	Weight (kg)	[model]
NOM 18	230	50	1	6,7	205	12631968
NOM 18 HEPA	230	50	1	6,7	215	12632068*
NOM 18	400/230	50	3	2,45/4,3	205	12632368
NOM 18 HEPA	400/230	50	3	1,45/4,3	215	12632468*
NOM 18 (without fan)					188	12632768**
NOM 18 HEPA (without fan)					198	12632868***
NOM 18 HEPA	220	60	1	2,37	215	12634268*
NOM 18 HEPA	380	60	3	2,37	215	12634368*
NOM 18	220	60	3	2,37	205	12634168
NOM 18	380	60	1	2,37	205	12634068

\*Includes HEPA filter with 24 sqm filterarea and with 99,97 % efficiency.

\*\*Delivered without Fan

\*\*\*Delivered without Fan. Includes HEPA filter with 24 sqm filterarea and with 99,97 % efficiency.

## NOM 18

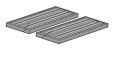
	[accessory]	[partno]
	FMS 1,6 - 2,5	14502237
	FMS 6,3 - 10	14502537
	Silencer NOM 18, 28	12373650
	Container NOM 11, 18, 28	12373651
	Hose with oil trap NOM	12373652
	Filter cover for NOM filter	12376746
	FMS 2.5-4 Fan Manual Starter incl. motor protector 2.5-4A	14502337
	HEPA filter NOM 18 (replacement)	12373647
	Mainfilter NOM 18 (replacement)	12373655
	Coarse pre-filter	12376294

## NOM 18

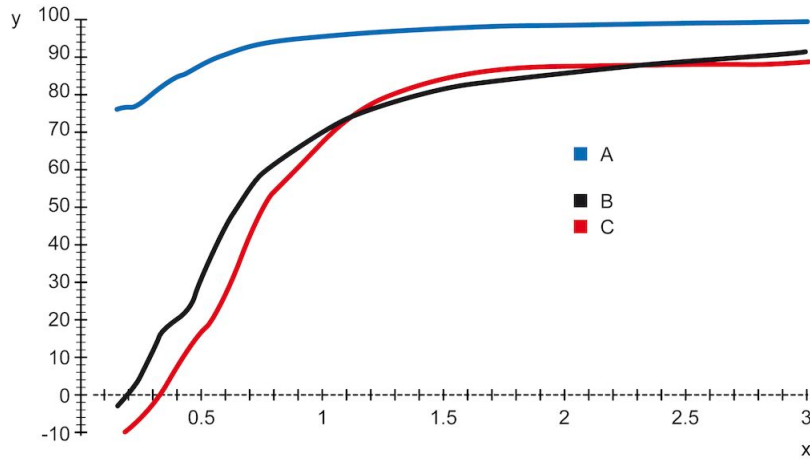

Y = Efficiency (%), X = Particle size (µm)

A = NOM filter, B = Centrifugal filter A, C = Centrifugal filter B

Efficiency of NOM main filter compared to typical centrifugal filters, tested with DOP.

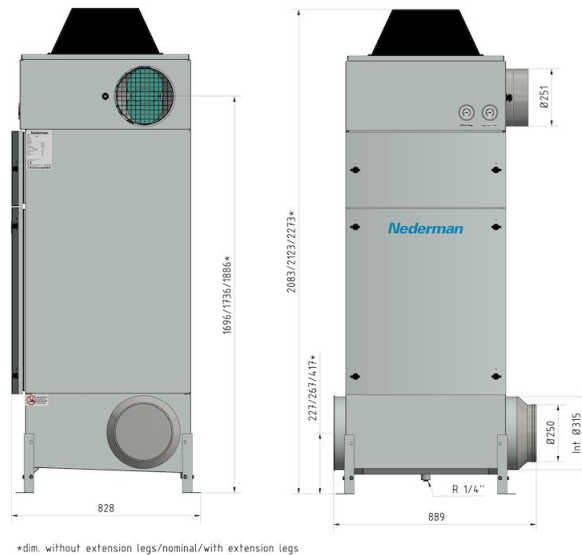

\*dim. without extension legs/nominal/with extension legs

## NOM 18

