

Description : HVCP Std 45kW Insight
Part no. : 2183721/2183627
Drawing no. : 2183626

AB Ph. Nederman & Co

Sydhamnsgatan 2 SE-25228 Helsingborg , Sweden

Tel: +46 42 20 89 87 Fax: +46 42 20 89 58

Last page no. :1022
Number of pages : 60

This schematic is AB Ph. Nederman & Co property. The schematic and any adjoining information must not be made accessible to representatives of other companies without our permission

Revision	2	Product	HVCP Std 45kW Insight			FRONTPAGE	Drawing no.	Page no.
Status	Available			2183626			1	
Date of approval	-	Date of created	2020-03-25					
Approval by	-	Author	FRALE					Next page

Page no.	Title	Last edit date
1	FRONTPAGE	2019-11-29
2	INDEX	2019-11-29
5	REVISION OVERVIEW	2019-08-22
6	PANEL SPECIFICATION	2019-11-29
7	WIRE SPECIFICATION ELECTRICAL INSTALLATION	2019-11-18
8	WIRE SPECIFICATION ELECTRICAL INSTALLATION	2018-01-04
9	FRONT PANEL LAYOUT	2020-04-17
10	PANEL LAYOUT	2020-04-17
11	TERMINAL ROW	2019-11-29
12	PANEL BOTTOM VIEW	2020-03-25
50	POWER SUPPLY	2020-04-17
60	CONTROL VOLTAGE	2020-04-17
70	EMERGENCY STOP CIRCUIT	2020-04-17
71	EMERGENCY STOP CIRCUIT	2020-04-17
80	MOTOR Y-D START	2020-04-17
81	MOTOR PTC SENSOR	2019-11-29
82	POWER SUPPLY 24VAC/24VDC	2019-09-03
200	PLC POWER SUPPLY	2019-11-29
210	HMI PANEL	2019-11-29
220	PLC DI/DO REFERENCE	2019-08-29
221	PLC AI REFERENCE	2019-08-22
222	PLC DI/DO SB1222 OPTIONAL	2019-08-07
230	PLC INPUT TERMINALS	2020-04-17
231	PLC INPUT TERMINALS	2019-09-24
232	PLC INPUT TERMINALS	2019-11-29
233	PLC INPUT TERMINALS	2019-11-29
238	PLC OUTPUT TERMINALS	2019-11-29
239	PLC OUTPUT TERMINALS	2019-11-19
240	PLC OUTPUT TERMINALS	2019-11-29

This schematic is AB Ph. Nederman & Co property. The schematic and any adjoining information must not be made accessible to representatives of other companies without our permission

Revision	2	Product	HVCP Std 45kW Insight			INDEX	Drawing no.	Page no.
Status	Available	Date of created	2020-03-25	2183626			2	
Date of approval	-	Author	FRALE					
Approval by	-	1	previous page	Next page			3	

Page no.	Title	Last edit date
241	SB1222 OUTPUT	2019-11-29
248	PLC 0-10V DC ANALOGUE INPUT	2019-11-29
249	Spare Terminal	2019-11-29
500	STARTER EXTERNAL CONNECTIONS	2019-11-29
501	STARTER EXTERNAL CONNECTIONS	2019-11-29
502	STARTER EXTERNAL CONNECTIONS	2019-11-29
503	STARTER EXTERNAL CONNECTIONS	2020-04-17
504	OPTIONAL CONNECTIONS MASTER-SLAVE	2018-01-04
505	OPTIONAL CONNECTIONS MASTER-SLAVE	2018-01-04
508	VAC ASC CONNECTIONS and OPTIONAL BLI	2019-11-29
509	RBU CONNECTIONS and OPTIONAL BLI	2019-06-05
510	SENSORS VIA AUXILIARY CONNECTION BOX	2019-11-19
	Lists	
1001	COMPONENT LIST	2020-04-17
1002	COMPONENT LIST	2020-04-17
1003	COMPONENT LIST	2019-11-29
1004	COMPONENT LIST	2020-04-17
1005	COMPONENT LIST	2020-04-17
1006	COMPONENT LIST	2020-04-17
1007	COMPONENT LIST	2020-04-17
1011	PLC LIST	2020-04-17
1014	CABEL OVERVIEW	2020-04-17
1017	TERMINAL LIST	2020-04-17

This schematic is AB Ph. Nederman & Co property. The schematic and any adjoining information must not be made accessible to representatives of other companies without our permission

Revision	2	Product	HVCP Std 45kW Insight			INDEX	Drawing no.	Page no.
Status	Available	Date of created	2020-03-25	2183626			3	
Date of approval	-	Author	FRALE					
Approval by	-			Next page			5	
2	previous page							

Standards/Directives:

EN60 204-1

EN61000-6-4

The control panel is suitable to be connected to
TN-S, TN-C, TN-C-S grid**Electrical specifications:**

Motor size: 30kW-220/230/240V 50/60Hz
30-45kW-380/400/440/460V 50/60Hz

Supply Voltage: 3x(220/230/240)VAC PE 50/60Hz
3x(380/400/440/460)VAC PE 50/60Hz

Short Circuit Current Ratings: 30kA

Frequency: 50/60 Hz

Type: Y/D

H x W x D(mm): 800 x 800 x 300

Control Voltage: 24V AC/ DC

Transformer: 340VA/160VA

Supply To External Equipment: 24V AC 2A, 24V DC 2A

Max installation ambient temperature
40 °C / 104 °F**Mechanical specifications:**

Degree of protection: IP65

Weight: 54Kg

Recyclable Materials: 100%

Labels, markings and other possible accessories according to product BOM

Responsible and Warranty:

Any kind of responsibility and warranty disappears if changes are made by others
than responsible Nederman Product Center

This schematic is AB Ph. Nederman & Co property. The schematic and any adjoining information must not be made accessible to representatives of other companies without our permission

Revision	2	Product	HVCP Std 45kW Insight			PANEL SPECIFICATION	Drawing no.	Page no.
Status	Available	Date of created	2020-03-25	2183626			6	
Date of approval	-	Author	FRALE					
Approval by	-			Next page			7	
5	previous page							

Wire specification:**Power cables:**

Insulation Material: PVC or PEX,EPR equivalent

Temperature: 70°C

Approvals: CE

Signal cables:

Material and type: PVC or PEX,EPR equivalent

Temperature: 70°C

Approvals: CE

Cables colour and conductor sectional area:

Protective conductor: Yellow/Green Variable

Power circuits: Black Variable

External control voltage: Orange 0,5mm²24VAC Phase: Red 1,5mm²0VAC Neutral: Red 1,5mm²24VDC Phase (+): Dark blue 0,5mm²0VDC Neutral (-): Dark blue 0,5mm²Analog signal: Purple 0,5mm²

Undefined Signal: --

Labels, markings and other possible accessories according to product BOM

Responsible and Warranty:

Any kind of responsibility and warranty disappears if changes are made by others than responsible Nederman Product Center

This schematic is AB Ph. Nederman & Co property. The schematic and any adjoining information must not be made accessible to representatives of other companies without our permission

Revision	2	Product	HVCP Std 45kW Insight			WIRE SPECIFICATION ELECTRICAL INSTALLATION	Drawing no. 2183626	Page no. 7
Status	Available	Date of created	2020-03-25					
Date of approval	-	Author	FRALE					
Approval by	-							
6	previous page						Next page	8

Wire specification:**Colour code:**

BK:	Black
BN:	Brown
BU:	Blue
GN:	Green
GY:	Grey
RD:	Red
WH:	White
PK:	Pink
PU:	Purple

Cables number grouping

Power Cables	W0 ----->W49
Shielded Power Cables	W50---->W99
Input Signal Cables 0-48V	W101--> W199
Output Signal Cables 0-48V	W200--> W399
Shielded Signal Cables	W500--> W599
Multi I/O Cable	W110

Labels, markings and other possible accessories according to product BOM

Installation of external accessories:

Dimension and types shown are only recommendations. it is the responsibility of the electrician to ensure that local and/or national regulations are met.

Note:

Do not use aluminium cable connect to main switch or contactors. Including motor cables.

Note:

There are limitations of software that determine which ones possible components that can be connected to inputs and outputs. This means that some cabinets do not have all the I/O functionality shown in the electrical diagram.

Responsible and Warranty:

Any kind of responsibility and warranty disappears if changes is made by others than responsible Nederman Product Center

This schematic is AB Ph. Nederman & Co property. The schematic and any adjoining information must not be made accessible to representatives of other companies without our permission

Revision	2	Product	HVCP Std 45kW Insight			WIRE SPECIFICATION ELECTRICAL INSTALLATION	Drawing no.	Page no.
Status	Available	Date of created	2020-03-25	2183626			8	
Date of approval	-	Author	FRALE					
Approval by	-			Next page			9	
7	previous page							

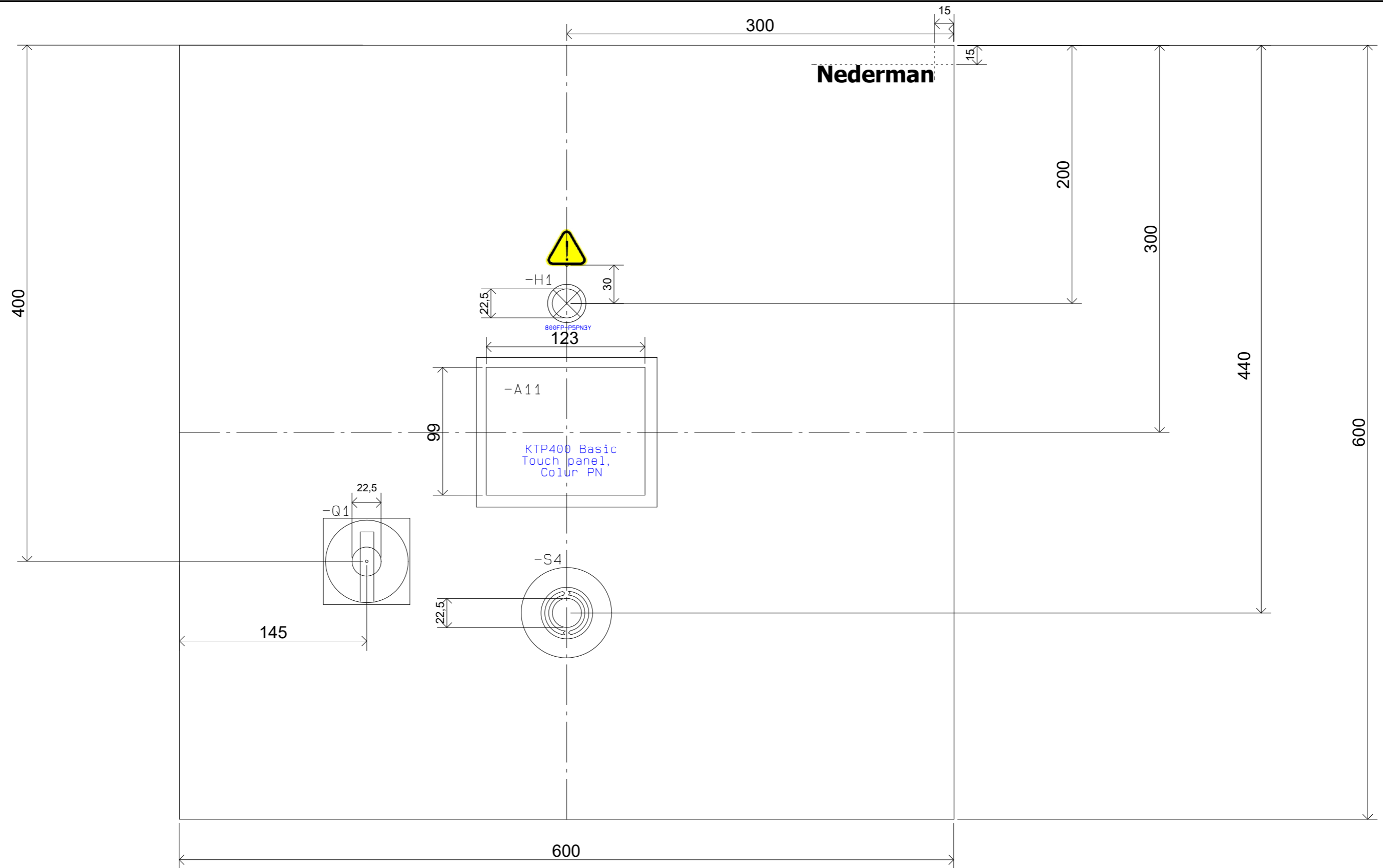

Components or parts with the text "Marked:" must be marked with specified text. Label, decal or marker cards or equivalent.
 This schematic is AB Ph. Nederman & Co property. The schematic and any adjoining information must not be made accessible to representatives of other companies without our permission

Revision	2	Product	HVCP Std 45kW Insight	
Status	Available	Date of created	2020-03-25	
Date of approval	-	Author	FRALE	
Approval by	-			
8	previous page			



FRONT
PANEL LAYOUT

Drawing no.
2183626

Page no.
9
Next page 10

Rital AE 600x600x250

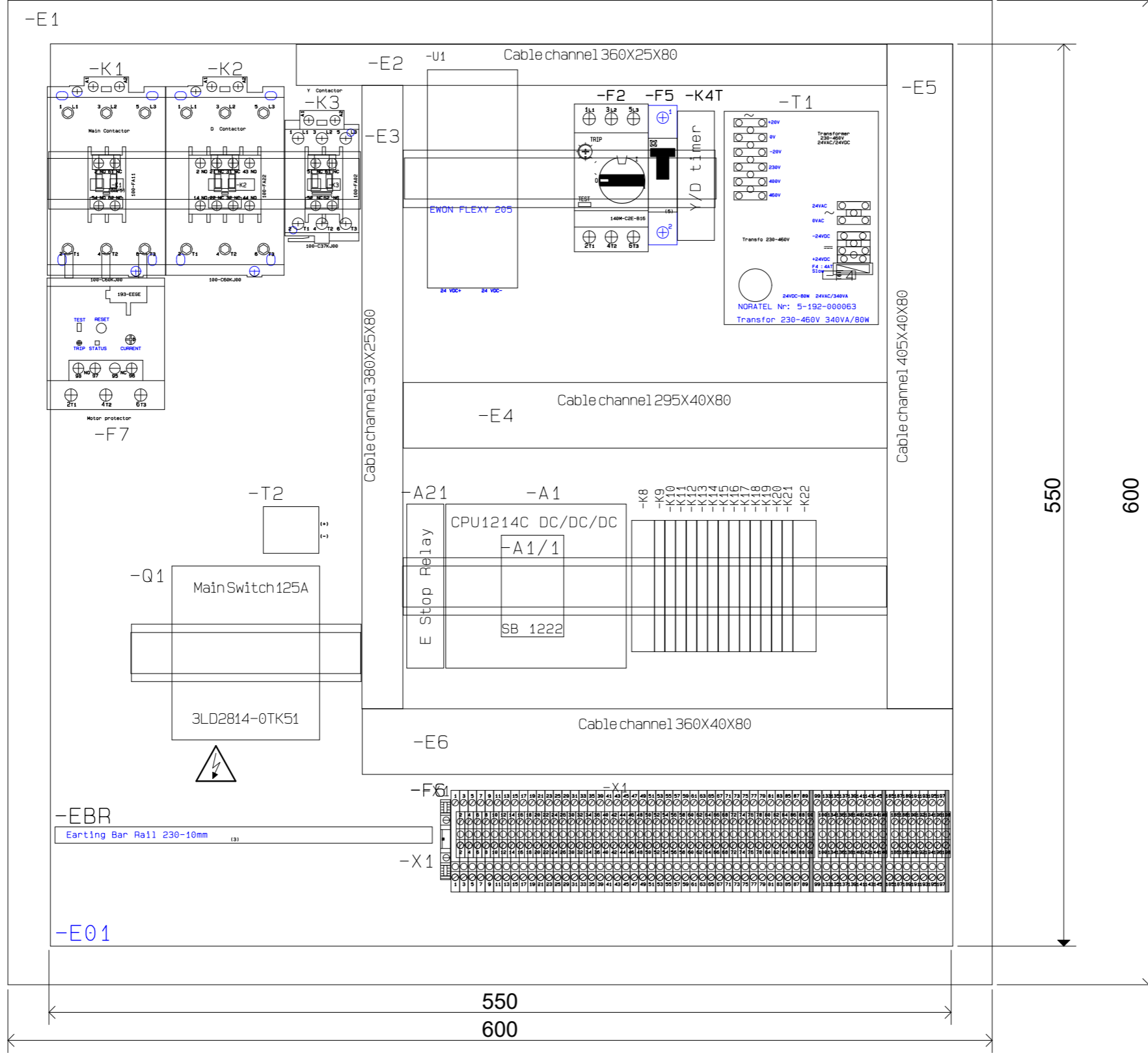

Note: U1 is an optional component. If not fitted, terminations for unused connections fitted instead.

Components or parts with the text "Marked:" must be marked with specified text. Label, decal or marker cards or equivalent.

A
Section A-A
(see page 12)

A

This schematic is AB Ph. Nederman & Co property. The schematic and any adjoining information must not be made accessible to representatives of other companies without our permission					PANEL LAYOUT	Drawing no. 2183626	Page no. 10
Revision Status Date of approval Approval by 9	2 Available - - previous page	Product HVCP Std 45kW Insight	Date of created 2020-03-25 Author FRALE				

-X 1

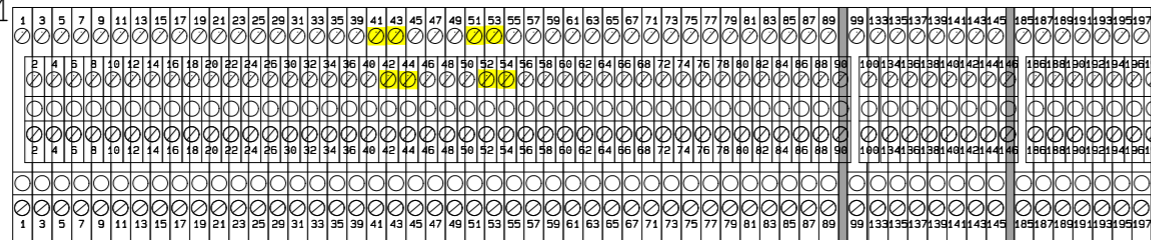

Terminals equipped with diode between levels marked with yellow marker.
Anode on upper level, cathode on lower level.

Terminals with diode:
41-42
43-44
51-52
53-54

This schematic is AB Ph. Nederman & Co property. The schematic and any adjoining information must not be made accessible to representatives of other companies without our permission

Revision	2	Product	HVCP Std 45kW Insight			TERMINAL ROW	Drawing no. 2183626	Page no. 11
Status	Available	Date of created	2020-03-25					
Date of approval	-	Author	FRALE					
Approval by	-							
10	previous page							Next page 12

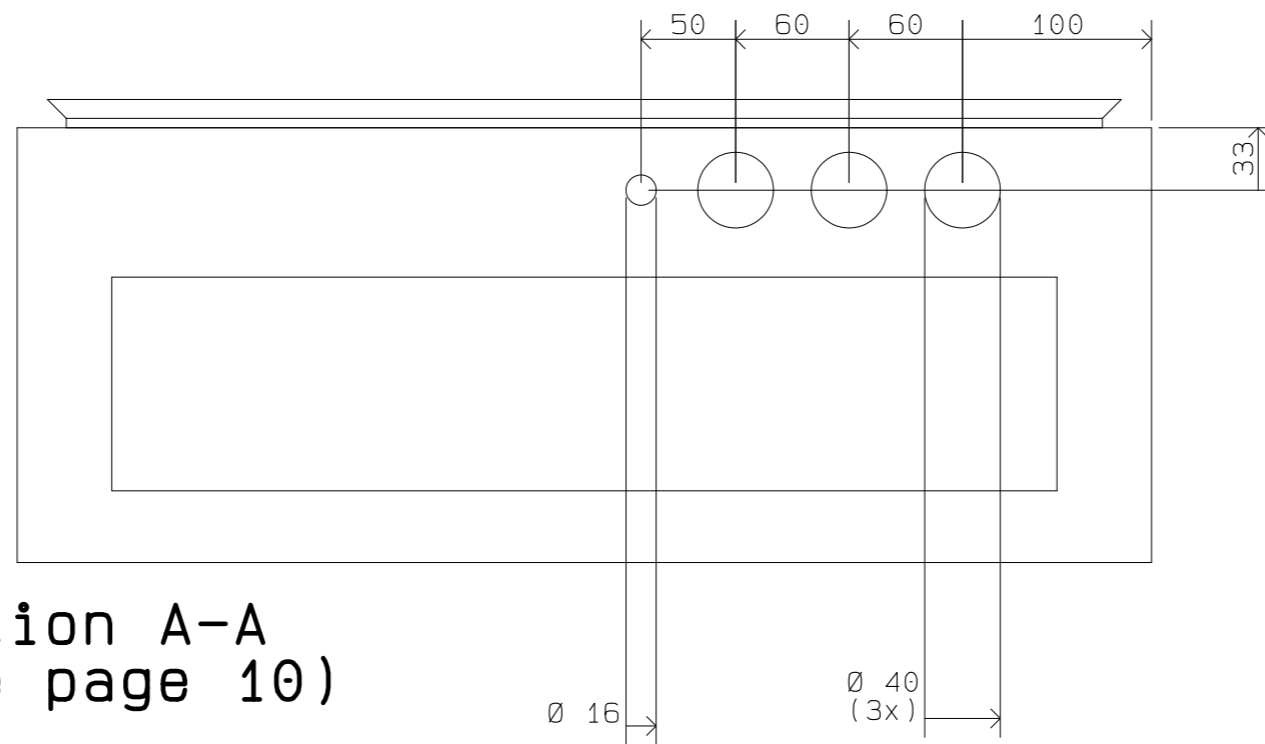

Section A-A
(see page 10)

This schematic is AB Ph. Nederman & Co property. The schematic and any adjoining information must not be made accessible to representatives of other companies without our permission

Revision	2	Product	HVCP Std 45kW Insight		Nederman	PANEL BOTTOM VIEW	Drawing no. 2183626	Page no. 12
Status	Available	Date of created	2020-03-25					
Date of approval	-	Author	FRALE					
Approval by	-							
11	previous page						Next page	50

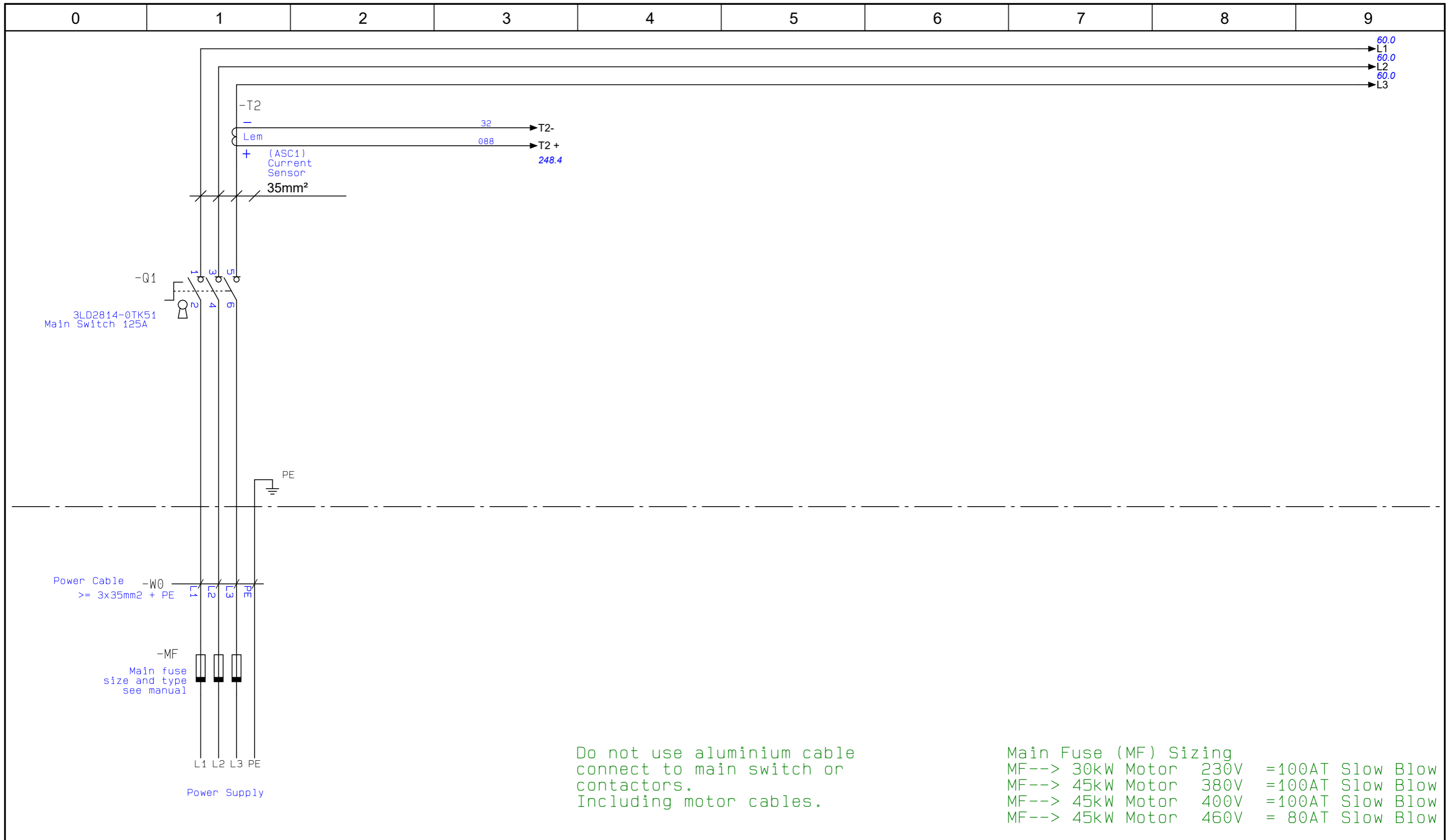

This schematic is AB Ph. Nederman & Co property. The schematic and any adjoining information must not be made accessible to representatives of other companies without our permission

Revision	2	Product	Product
Status	Available	HVCP Std 45kW Insight	
Date of approval	-	Date of created	2020-03-25
Approval by	-	Author	FRALE
12	previous page		

Nederman

POWER SUPPLY

Drawing no.
2183626

Page no.
50
Next page 60

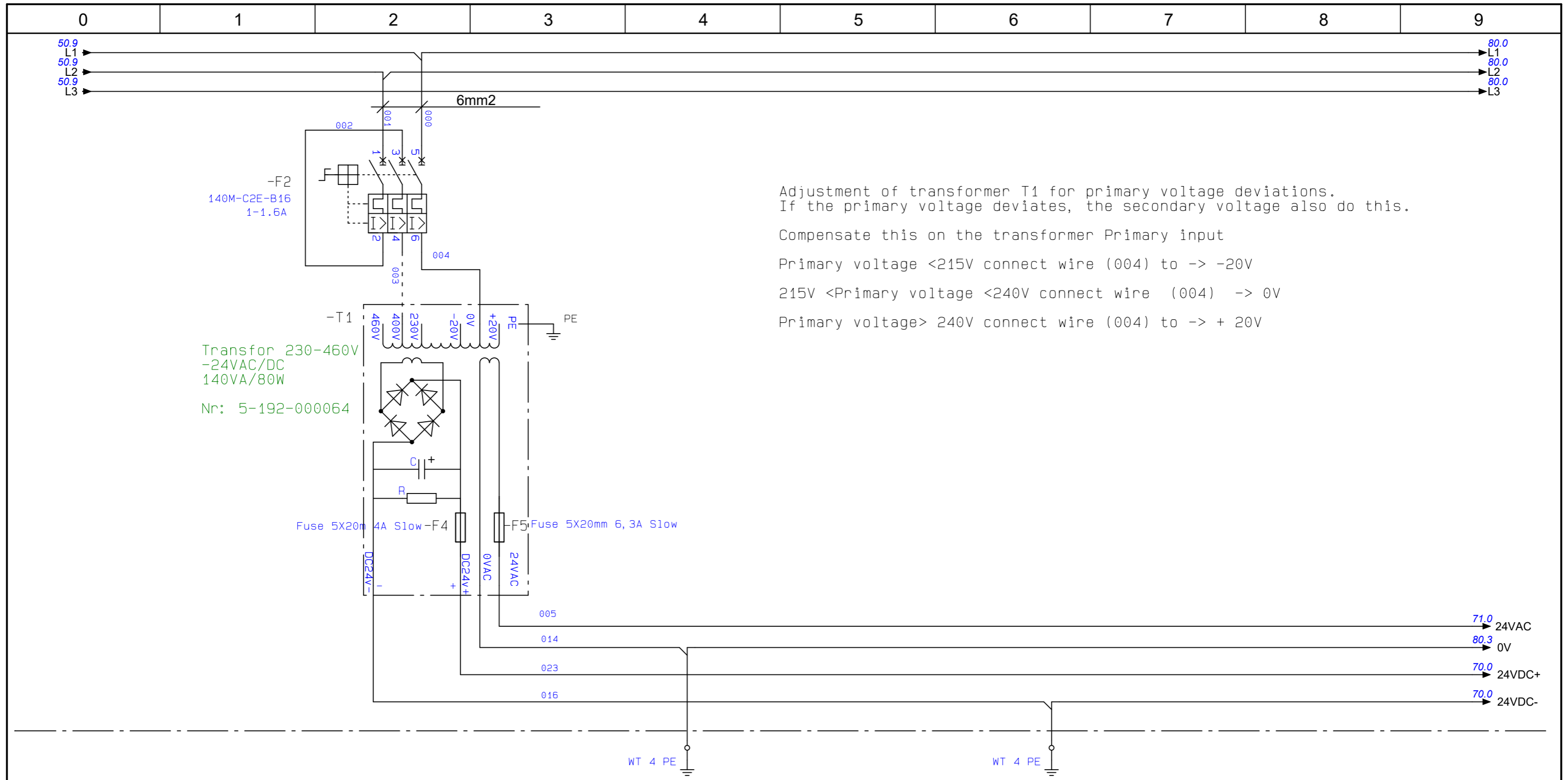

Adjustment of transformer T1 for primary voltage deviations.
 If the primary voltage deviates, the secondary voltage also do this.

Compensate this on the transformer Primary input

Primary voltage <215V connect wire (004) to -> -20V

215V <Primary voltage <240V connect wire (004) -> 0V

Primary voltage > 240V connect wire (004) to -> + 20V

-F2
 140M-C2E-B16
 1-1.6A

-T1
 Transfor 230-460V
 -24VAC/DC
 140VA/80W
 Nr: 5-192-000064

Fuse 5X20mm 4A Slow-F4

F5 Fuse 5X20mm 6,3A Slow

This schematic is AB Ph. Nederman & Co property. The schematic and any adjoining information must not be made accessible to representatives of other companies without our permission

Revision	2	Product	HVCP Std 45kW Insight
Status	Available	Date of created	2020-03-25
Date of approval	-	Author	FRALE
Approval by	-		
50	previous page		



CONTROL VOLTAGE	Drawing no.	Page no.
	2183626	60
		Next page 70

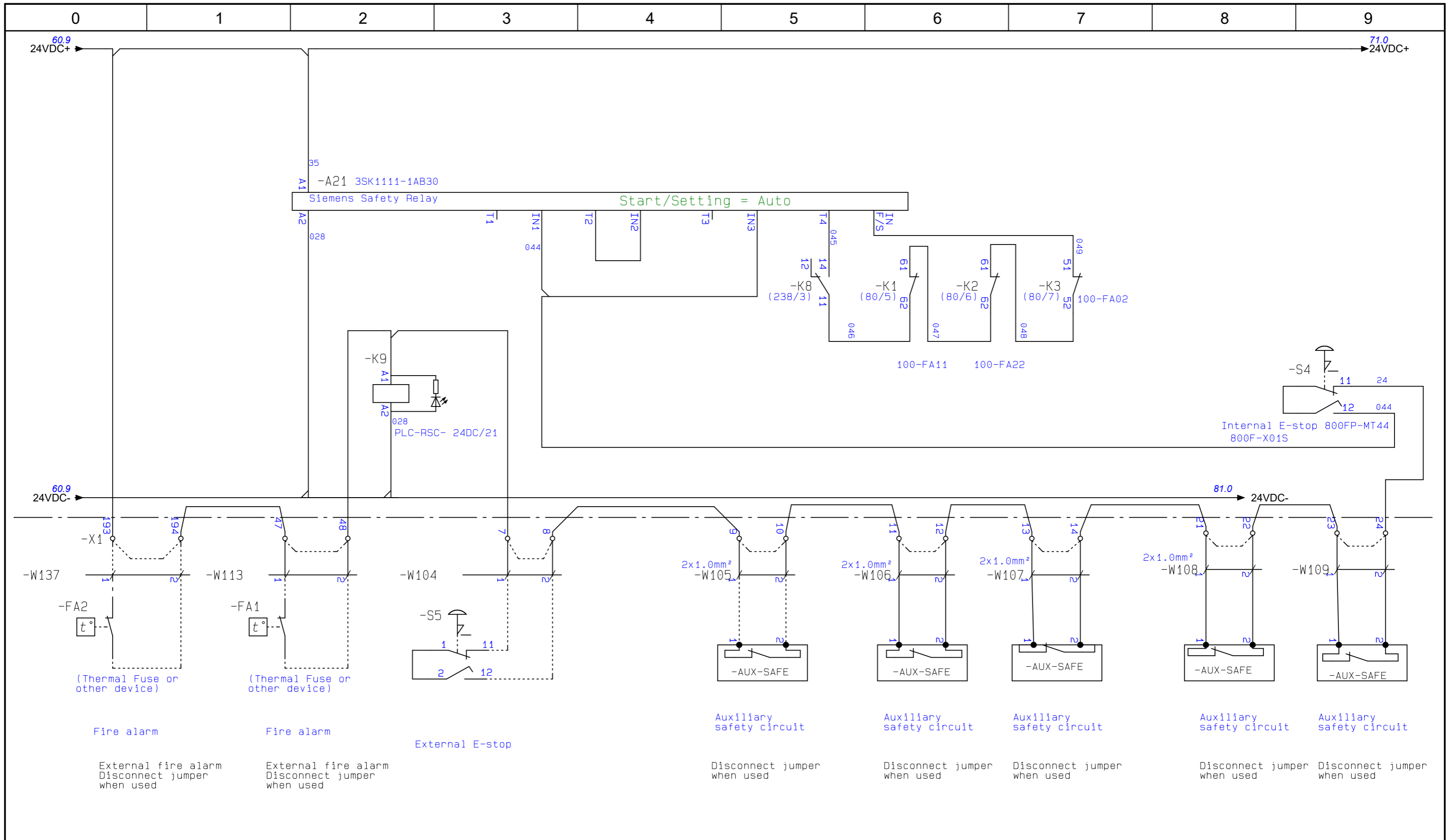

This schematic is AB Ph. Nederman & Co property. The schematic and any adjoining information must not be made accessible to representatives of other companies without our permission

Revision	2	Product	HVCP Std 45kW Insight	
Status	Available			
Date of approval	-	Date of created	2020-03-25	
Approval by	-	Author	FRALE	
60	previous page			



**EMERGENCY STOP
CIRCUIT**

Drawing no.
2183626

Page no.
70
Next page 71

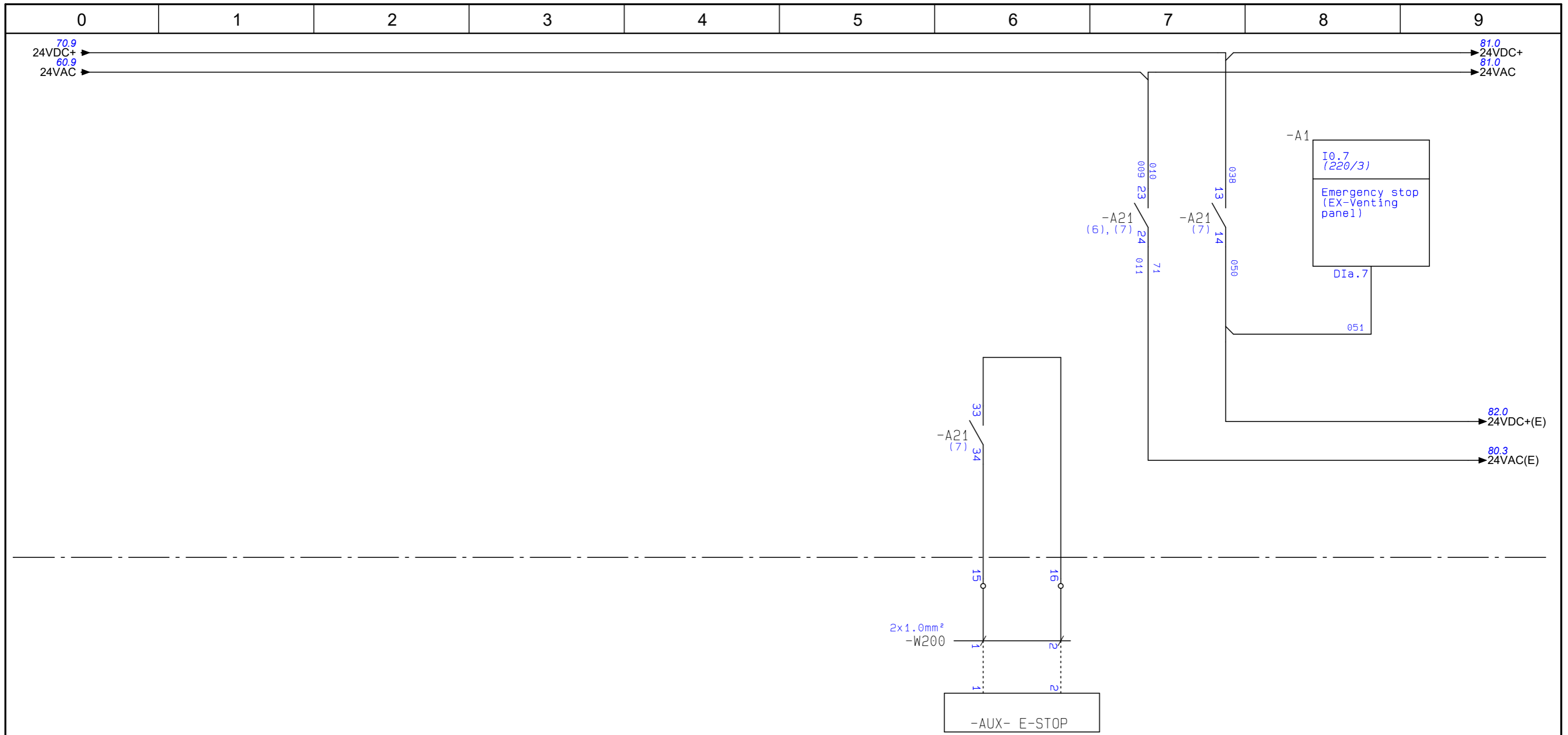

E-Stop signal to external control panel

This schematic is AB Ph. Nederman & Co property. The schematic and any adjoining information must not be made accessible to representatives of other companies without our permission

Revision	2	Product	HVCP Std 45kW Insight
Status	Available		
Date of approval	-	Date of created	2020-03-25
Approval by	-	Author	FRALE
70	previous page		



**EMERGENCY STOP
CIRCUIT**

Drawing no.
2183626

Page no.
71
Next page 80

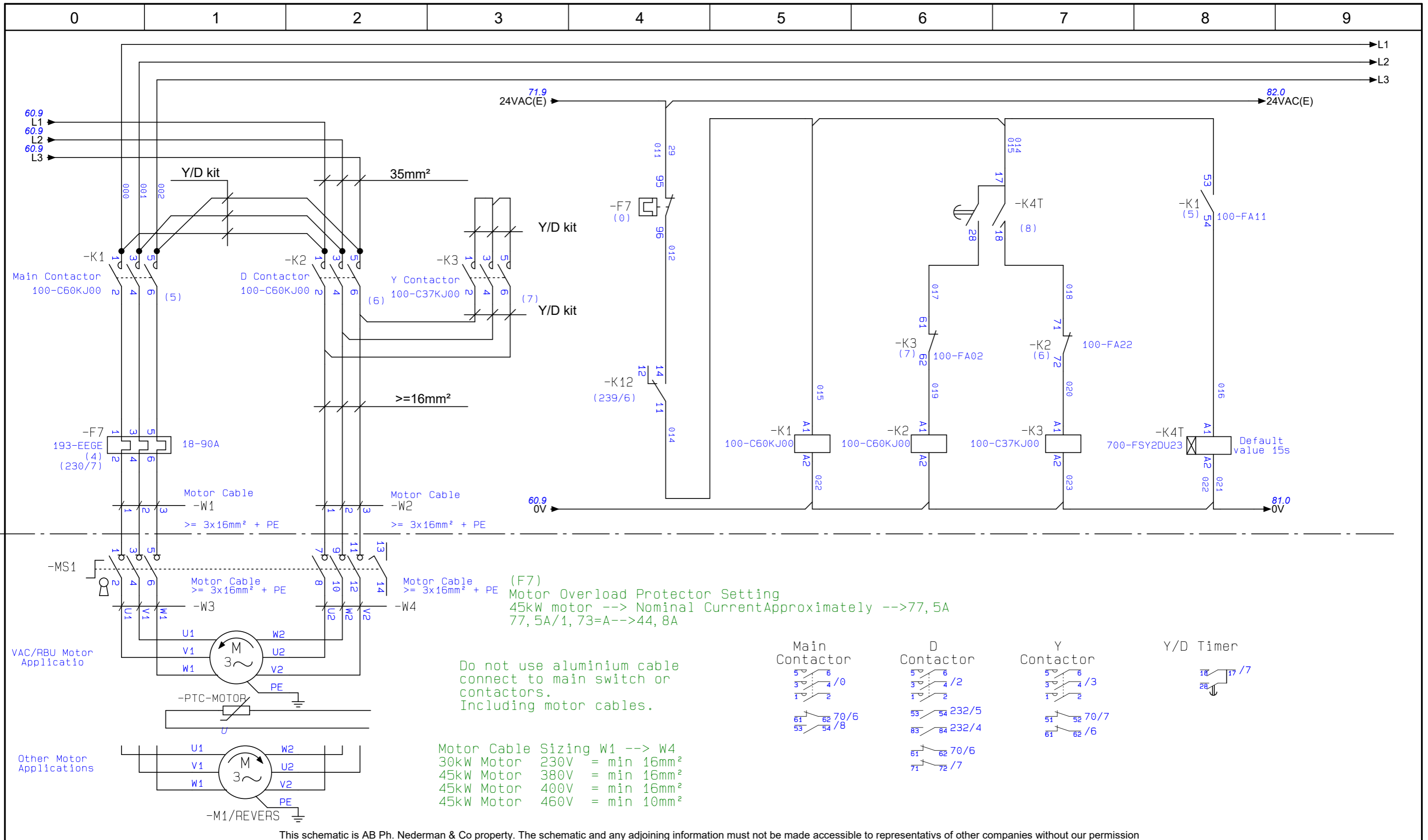

71.9
24VAC(E)

82.0
24VAC(E)

60.9
L1
60.9
L2
60.9
L3

60.9
0V

81.0
0V

(F7) Motor Overload Protector Setting
 45kW motor --> Nominal Current Approximately --> 77,5A
 77, 5A/1, 73=A-->44, 8A

Do not use aluminium cable
 connect to main switch or
 contactors.
 Including motor cables.

Motor Cable Sizing W1 --> W4
 30kW Motor 230V = min 16mm²
 45kW Motor 380V = min 16mm²
 45kW Motor 400V = min 16mm²
 45kW Motor 460V = min 10mm²

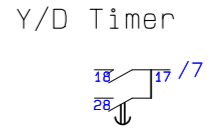
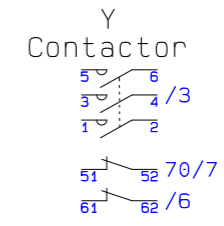
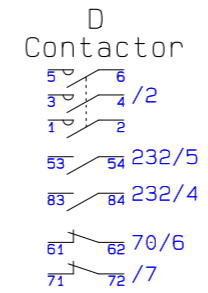
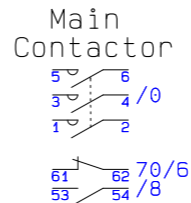

Revision	2
Status	Available
Date of approval	-
Approval by	-
71	previous page

Product	HVCP Std 45kW Insight		
Date of created	2020-03-25	Author	FRALE



MOTOR Y-D START

Drawing no.
2183626

Page no.
80
Next page 81

This schematic is AB Ph. Nederman & Co property. The schematic and any adjoining information must not be made accessible to representatives of other companies without our permission

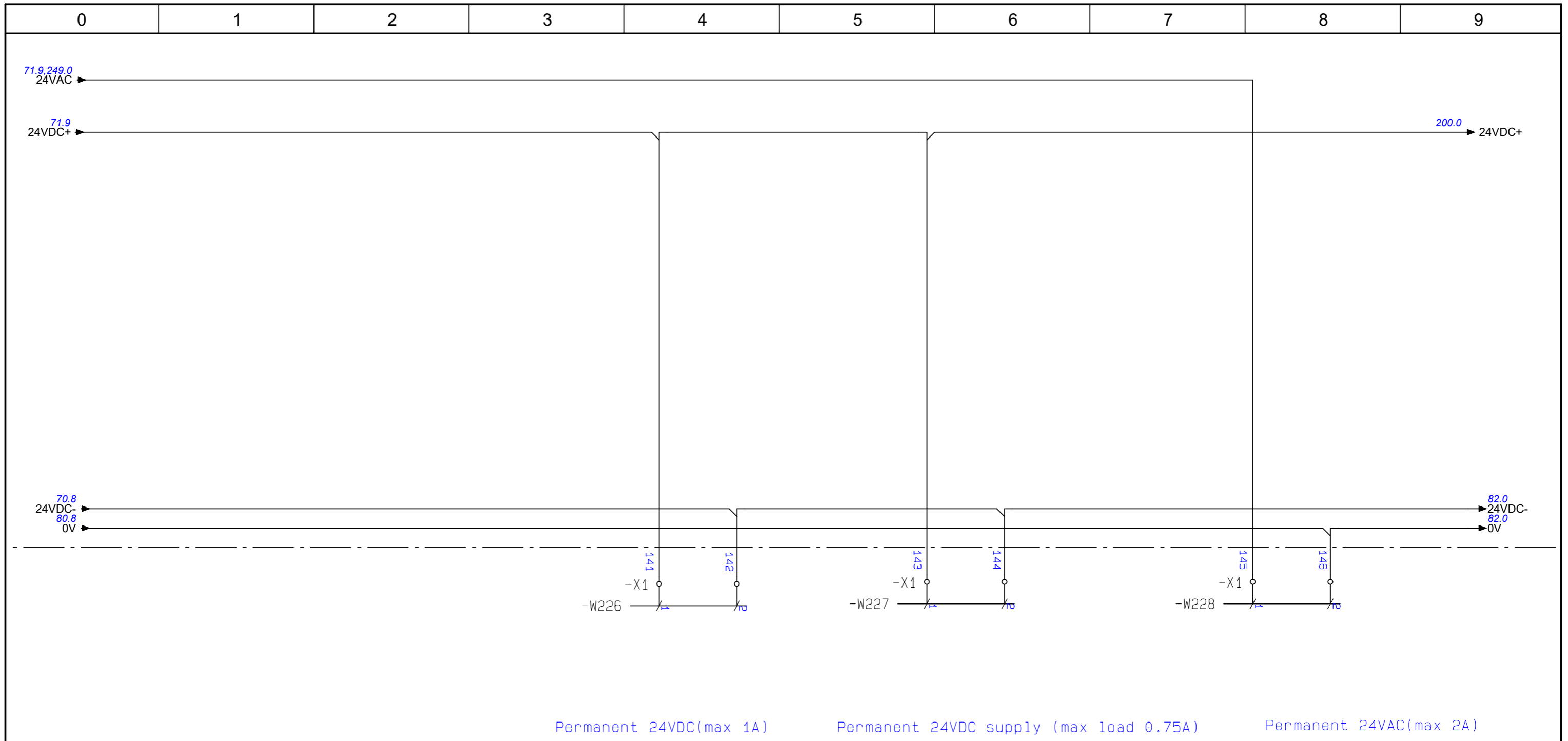

This schematic is AB Ph. Nederman & Co property. The schematic and any adjoining information must not be made accessible to representatives of other companies without our permission

Revision	2	Product	HVCP Std 45kW Insight		Nederman	MOTOR PTC SENSOR	Drawing no.	Page no.
Status	Available	Date of created	2020-03-25	2183626			81	
Date of approval	-	Author	FRALE					
Approval by	-	80	previous page	Next page			82	

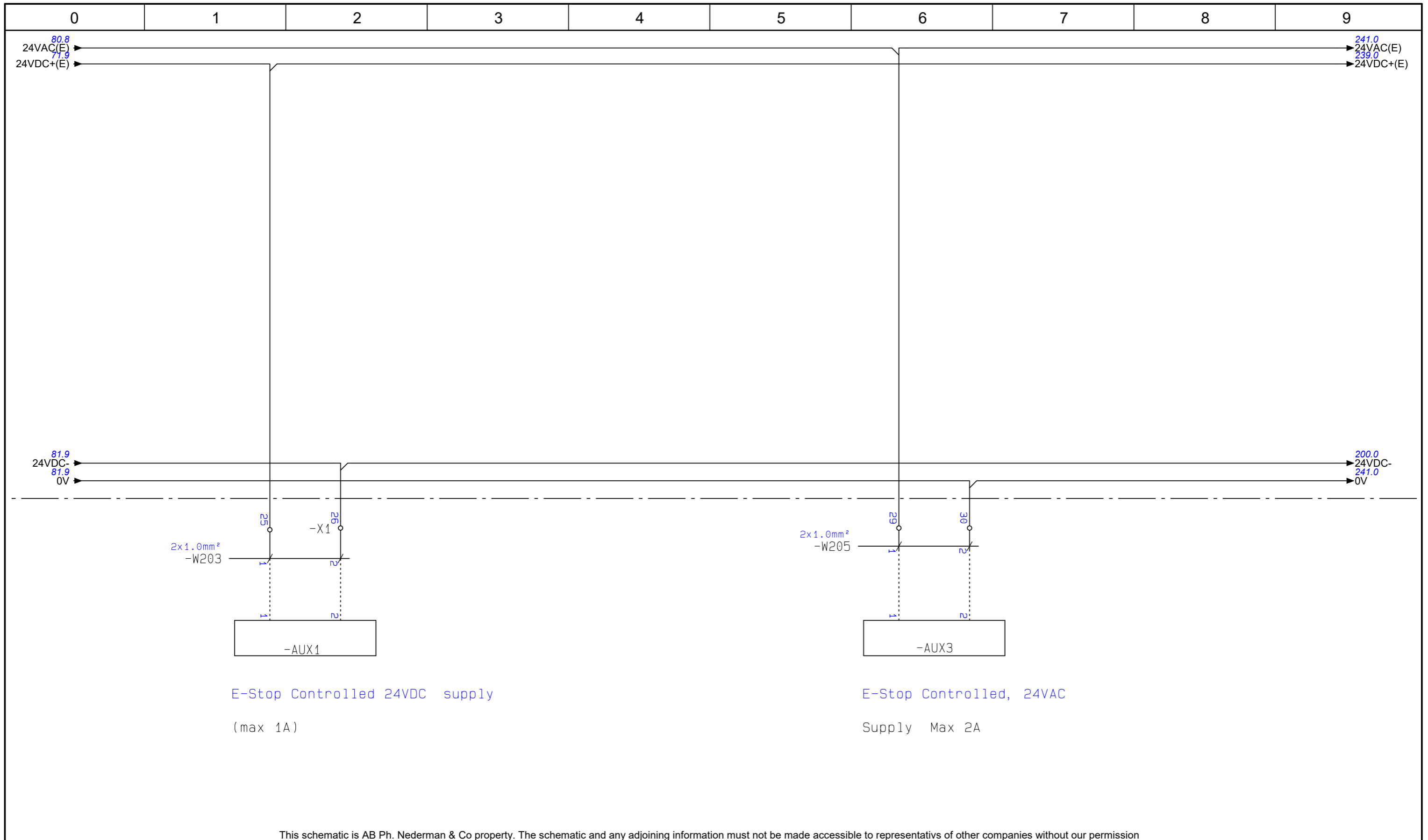

This schematic is AB Ph. Nederman & Co property. The schematic and any adjoining information must not be made accessible to representatives of other companies without our permission

Revision	2	Product	HVCP Std 45kW Insight			POWER SUPPLY 24VAC/24VDC	Drawing no. 2183626	Page no. 82
Status	Available							
Date of approval	-	Date of created	2020-03-25					
Approval by	-	Author	FRALE					
81	previous page						Next page	200

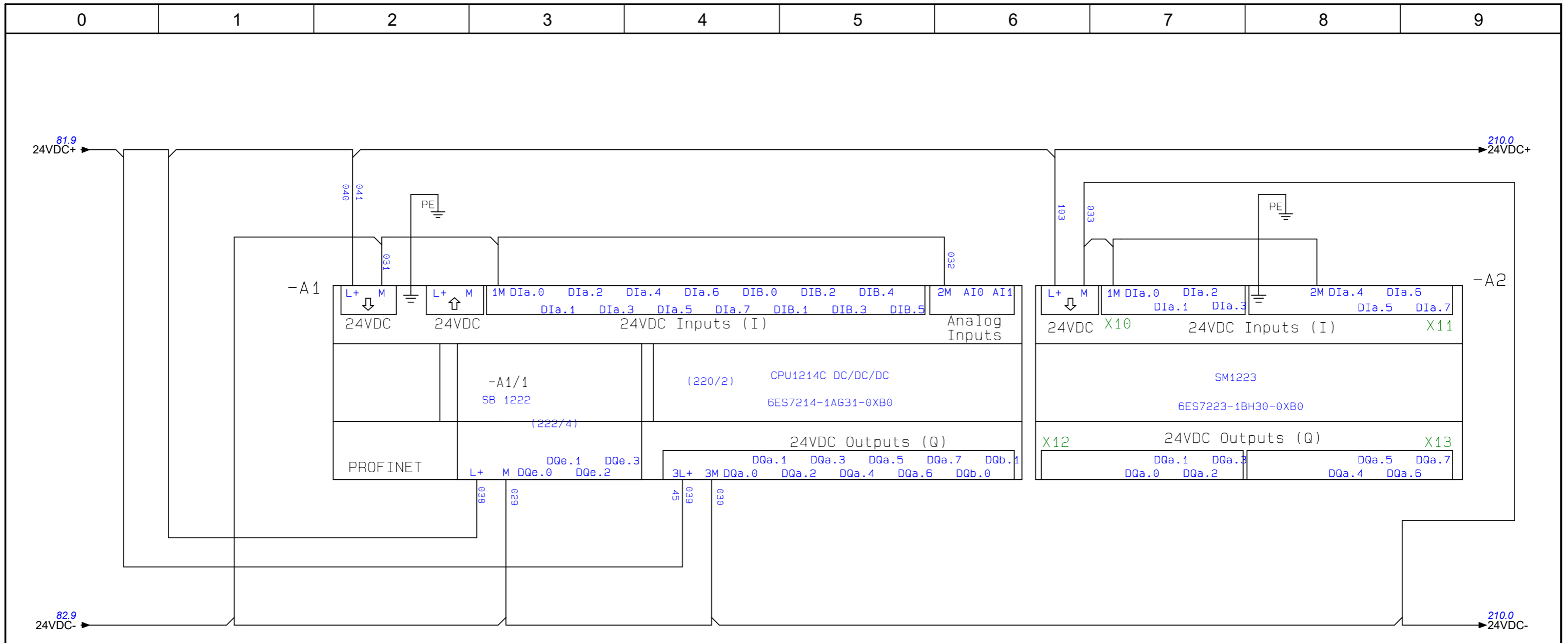

This schematic is AB Ph. Nederman & Co property. The schematic and any adjoining information must not be made accessible to representatives of other companies without our permission

Revision	2	Product	HVCP Std 45kW Insight			PLC POWER SUPPLY	Drawing no. 2183626	Page no. 200
Status	Available							
Date of approval	-	Date of created	2020-03-25					
Approval by	-	Author	FRALE					
82	previous page			Next page	210			

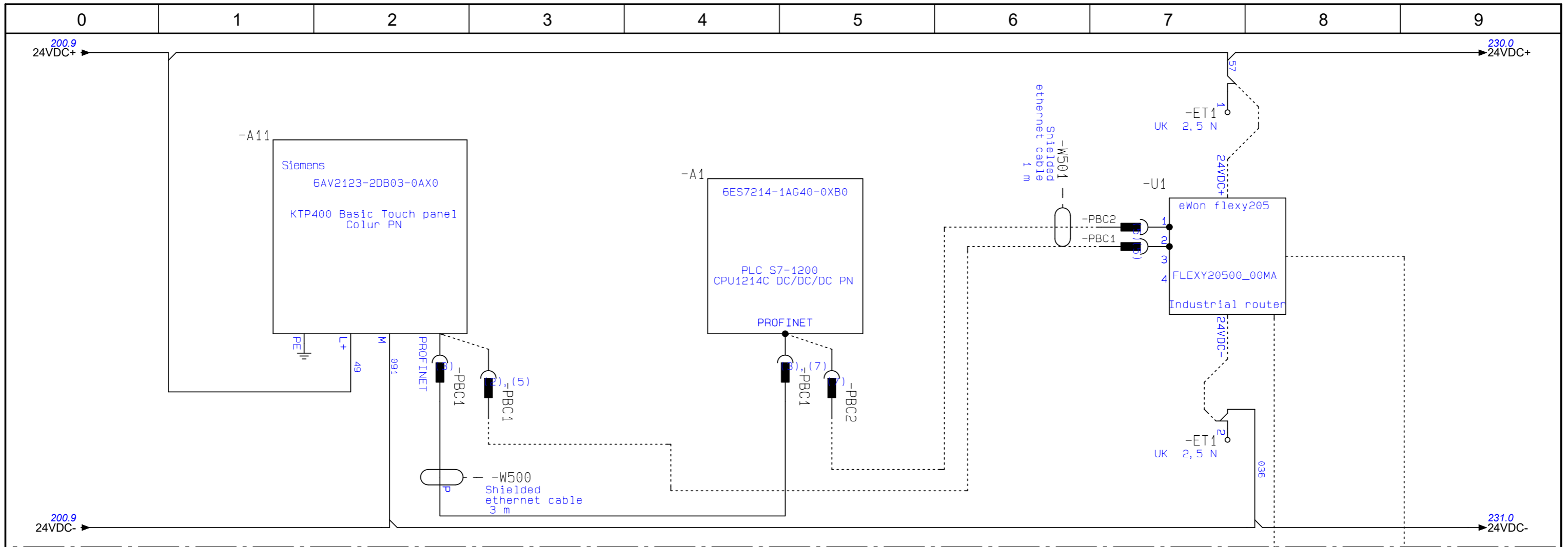

When U1 not installed:
PBC1 between A1 and A11 (3 m)

When U1 installed:
PBC1 between A11 and U1 (3 m)
PBC2 between A1 and U1 (1 m)

P1
4G antenna

Note: When installing router, disconnect wires from terminals ET1 and ET2 and connect to router. Remove ET1 and ET2. Antenna mounted externally

This schematic is AB Ph. Nederman & Co property. The schematic and any adjoining information must not be made accessible to representatives of other companies without our permission

Revision	2	Product	Product
Status	Available	HVCP Std 45kW Insight	
Date of approval	-	Date of created	2020-03-25
Approval by	-	Author	FRALE
200	previous page		



HMI PANEL

Drawing no.
2183626

Page no.
210
Next page 220

-A1

CPU1214C DC/DC/DC		(200/4), (7)
I0.0 (230/2)	Pilot Signal (PS)	DIa.0
I0.1 (230/5)	Compressed air switch (CAS)	DIa.1
I0.2 (230/7)	Thermal switches (TS)	DIa.2
I0.3 (230/8)	Motor protector +(PTC (EX))	DIa.3
I0.4 (231/1)	Level indicator on dust bin (BLI)	DIa.4
I0.5	Main filter DPS Configurable (DFC-OBM alarm (when no replica))	DIB.5
I0.6 (231/9)	Remote St.By/Off/OTTr	DIa.6
I0.7 (71/8)	Emergency stop (EX-Venting panel)	DIa.7
I1.0 (232/2)	Maintenance switch	DIB.0
I1.1 (232/6)	Closing function in D-mode	DIB.1
I1.2 (232/8)	Level Indicator (LI) (Emptying on demand) Configurable	DIB.2
I1.3 (233/0)	Control filter DPS 1 Configurable	DIB.3
I1.4 (233/6)	Manual emptying TVFD/AEB (NS)	DIB.4
I1.5 (233/8)	Fire Alarm	DIB.5
6ES7214-1AG40-0XB0		

-A1

CPU1214C DC/DC/DC		(2), (221/3)
Q0.0 (238/3)	NoAlarm (Reset Safety circ.)	DQa.0
Q0.1 (238/5)	Alarm message lamp lamp in front panel	DQa.1
Q0.2 (238/8)	Warning DPS BLI and LI (relay is energized at warnig active)	DQa.2
Q0.3 (239/2)	Filter Cleaning Valve V1 dust collector Configurable FlexF 13/18 v1 (replica)	DQa.3
Q0.4 (239/4)	Filter Cleaning Valve V2 dust collector Configurable FlexF 13/18 v1 (replica)	DQa.4
Q0.5 (239/6)	Run(Start motor)	DQa.5
Q0.6 (239/8)	Solenoid V10 in vacuum unit (Start up valve / Idling (RBU))	DQa.6
Q0.7 (240/3)	Upper solenoid V11 TVFD 1 Configurable	DQa.7
Q1.0 (240/5)	Lower solenoid V12 TVFD 1 Emptying AEB; Configurable	DQb.0
Q1.1 (240/8)	On/standby lamp (external)	DQb.1
6ES7214-1AG40-0XB0		

This schematic is AB Ph. Nederman & Co property. The schematic and any adjoining information must not be made accessible to representatives of other companies without our permission

-A1

CPU1214C DC/DC/DC		(220/7), (248/3)
AI0 (248/3)	(ASC) Current Sensor	AI0
AI1 (248/6)	Vacuum Sensor input dP FlexFilter 13/18	AI1
6ES7214-1A631-0XB0		

This schematic is AB Ph. Nederman & Co property. The schematic and any adjoining information must not be made accessible to representatives of other companies without our permission

-A1/1

SB 1222	(200/3)
4.00 (241/2)	Config output K19 ASC move/Flush 1 DQe.0
4.01 (241/4)	Config output K20 ASC open/Flush 2 DQe.1
4.02 (241/6)	LCC start DQe.2
4.03 (241/9)	MUX AI0 Current AI1 Pressure DQe.3
6ES7222-1BD30-0XB0	

This schematic is AB Ph. Nederman & Co property. The schematic and any adjoining information must not be made accessible to representatives of other companies without our permission

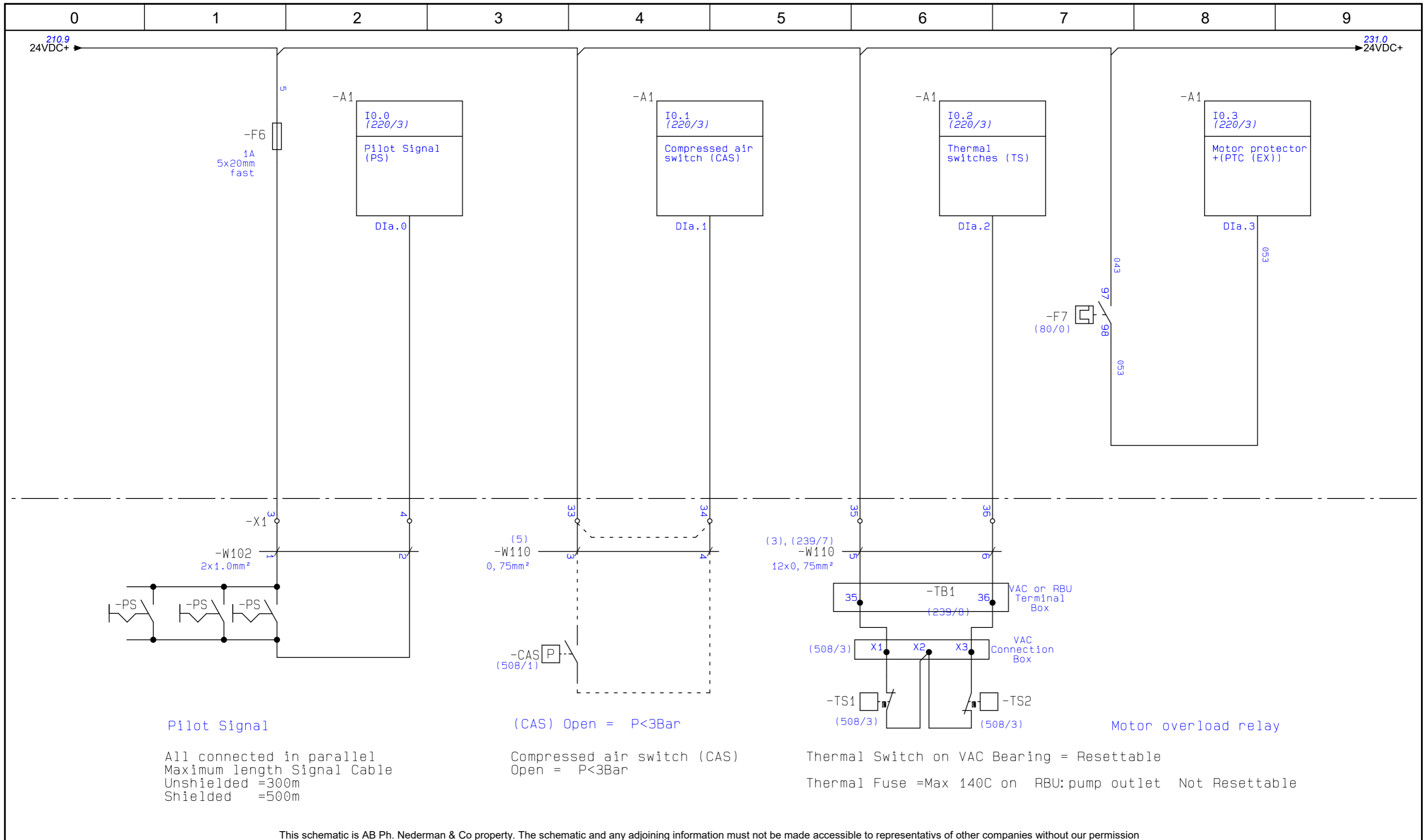

Revision	2	Product	Product
Status	Available	HVCP Std 45kW Insight	
Date of approval	-	Date of created	2020-03-25
Approval by	-	Author	FRALE
222	previous page		



PLC INPUT
TERMINALS

Drawing no.
2183626

Page no.
230
Next page 231

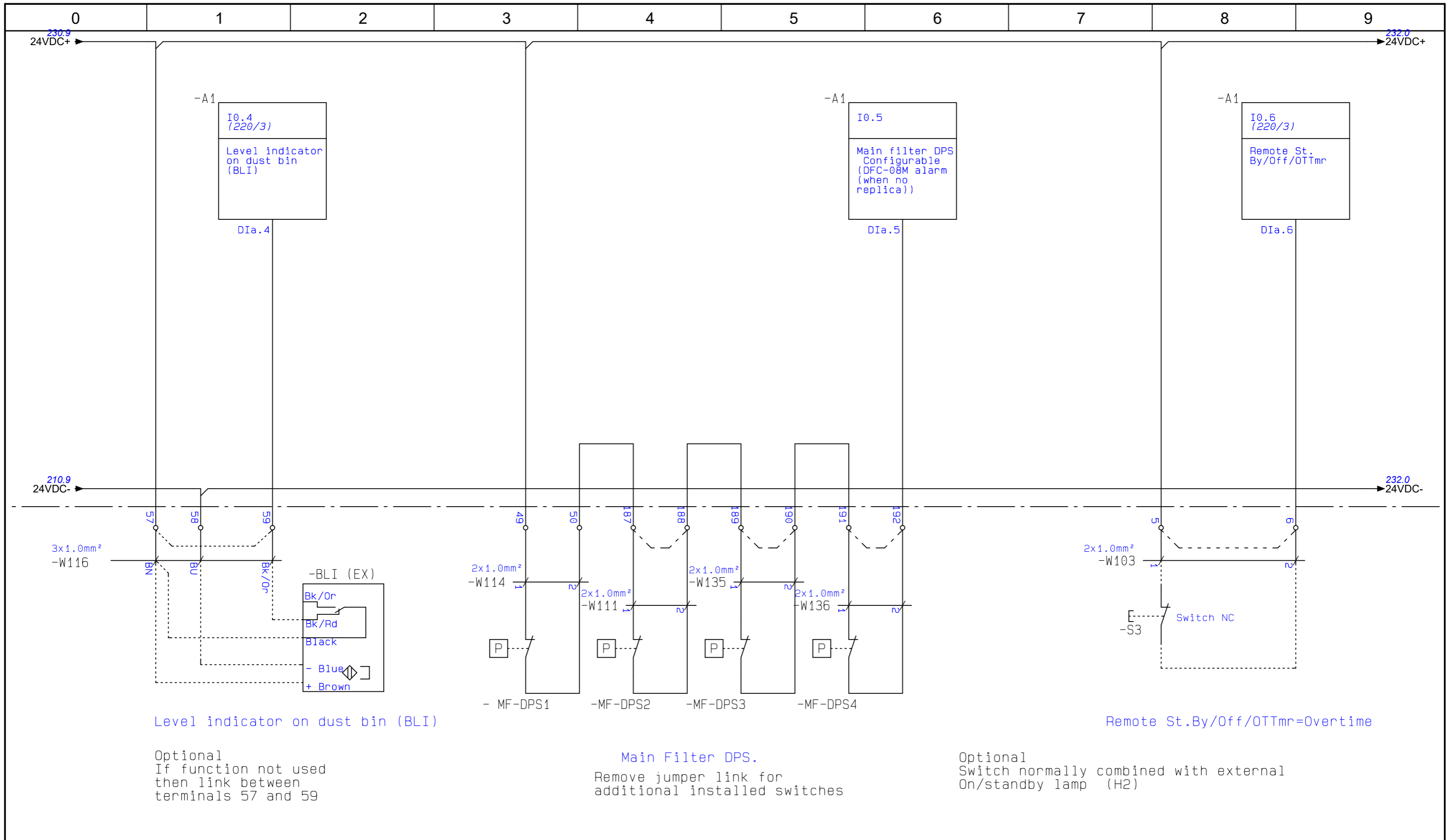

This schematic is AB Ph. Nederman & Co property. The schematic and any adjoining information must not be made accessible to representatives of other companies without our permission

Revision	2	Product	HVCP Std 45kW Insight
Status	Available		
Date of approval	-	Date of created	2020-03-25
Approval by	-	Author	FRALE
230	previous page		



PLC INPUT
TERMINALS

Drawing no.
2183626

Page no.
231

Next page 232

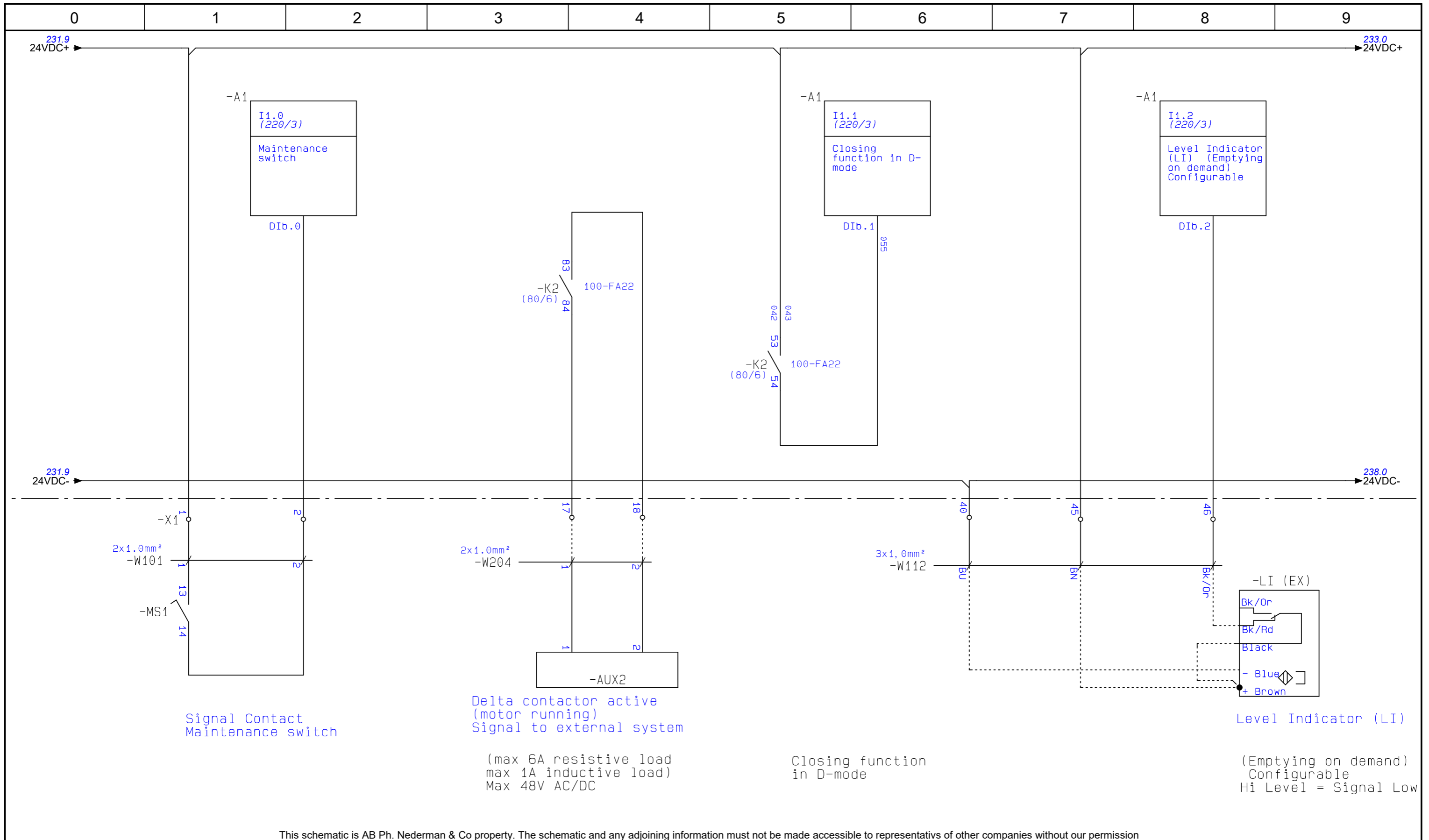

This schematic is AB Ph. Nederman & Co property. The schematic and any adjoining information must not be made accessible to representatives of other companies without our permission

Revision	2	Product	HVCP Std 45kW Insight		<h1>Nederman</h1>	PLC INPUT TERMINALS	Drawing no. 2183626	Page no. 232
Status	Available	Date of created	2020-03-25					
Date of approval	-	Author	FRALE					
Approval by	-							
231	previous page						Next page	233

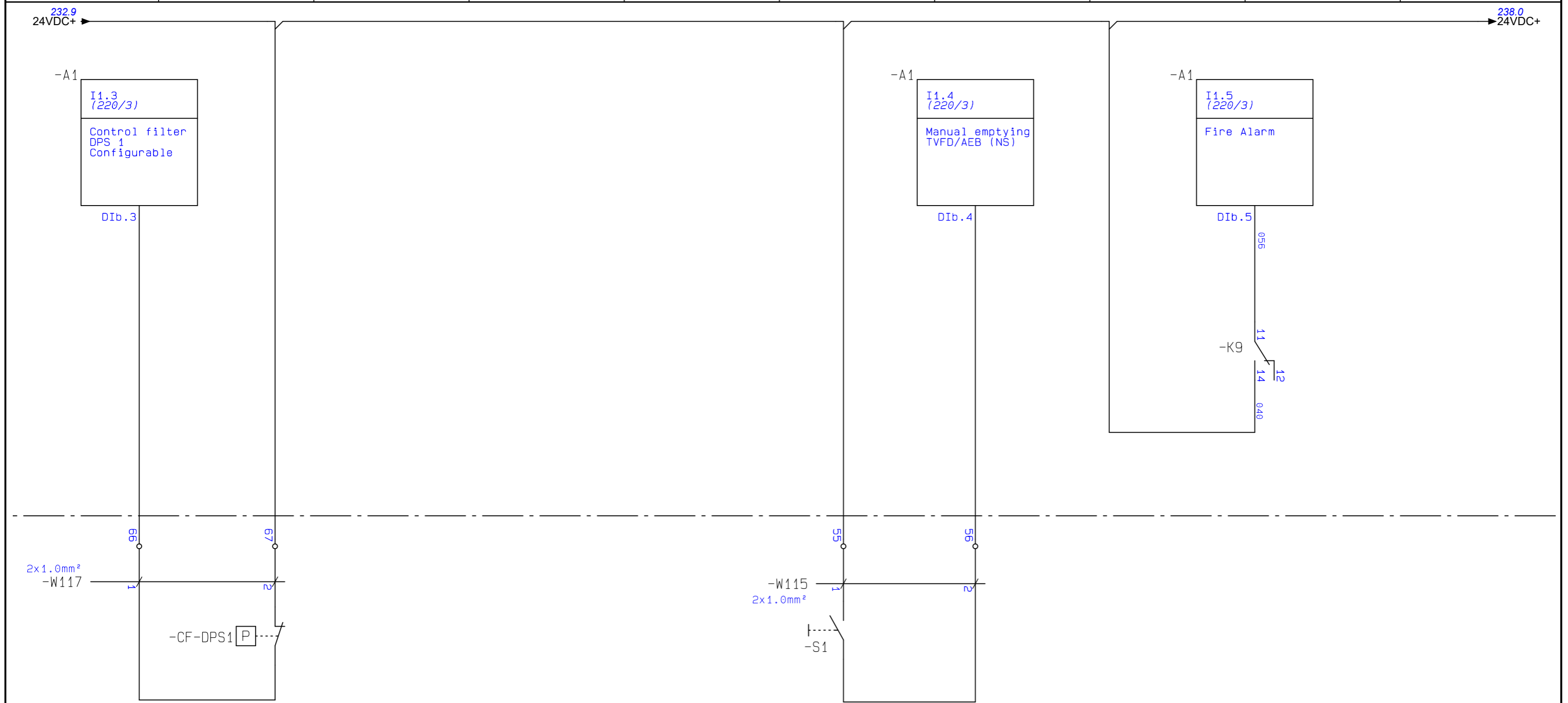

Control filter DPS (1) - (1-2)

Manual emptying TVFD/AEB (NS)

Fire Alarm

This schematic is AB Ph. Nederman & Co property. The schematic and any adjoining information must not be made accessible to representatives of other companies without our permission

Revision	2	Product	HVCP Std 45kW Insight
Status	Available		
Date of approval	-	Date of created	2020-03-25
Approval by	-	Author	FRALE
232	previous page		



PLC INPUT
TERMINALS

Drawing no.
2183626

Page no.
233
Next page 238

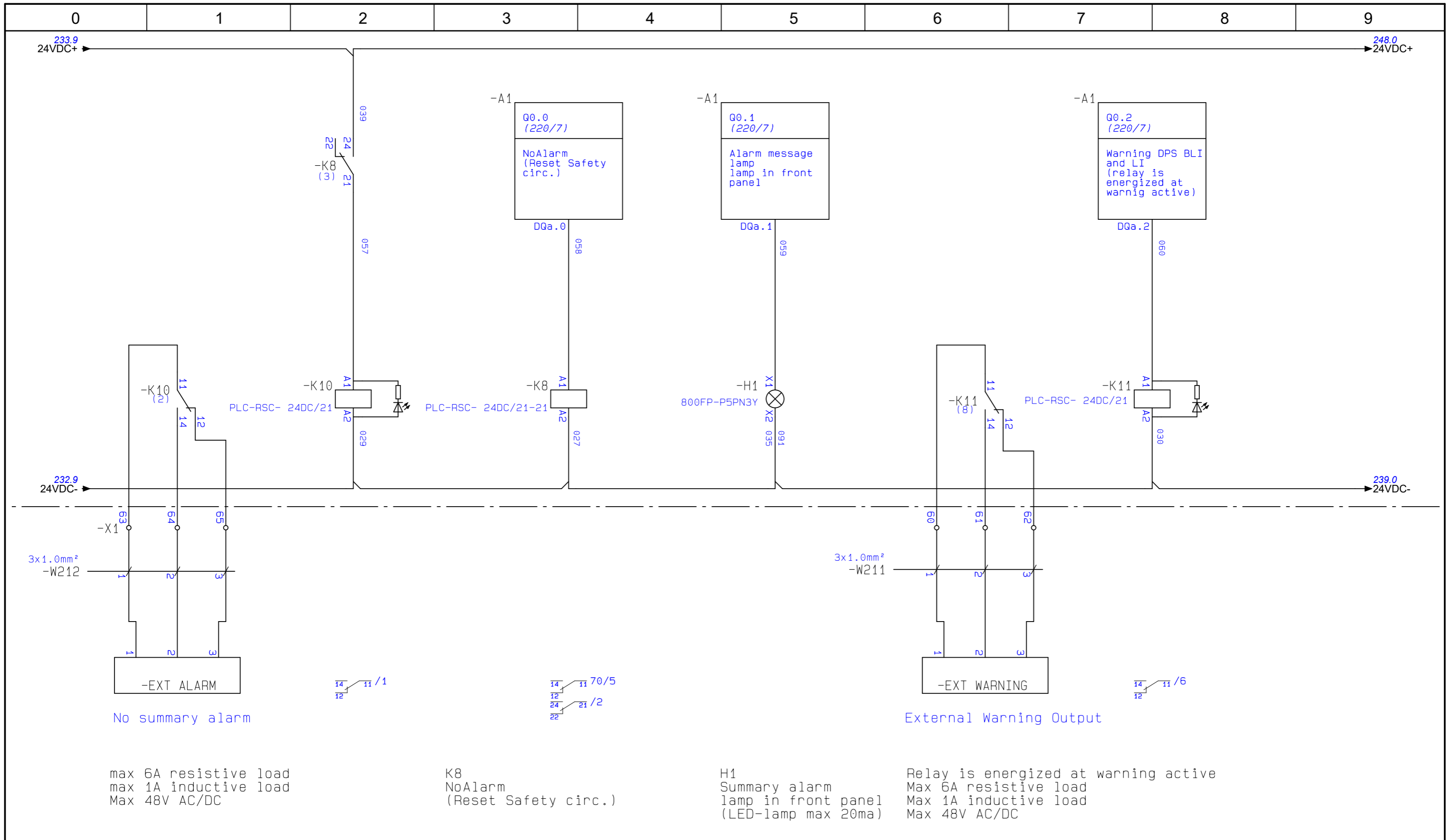

This schematic is AB Ph. Nederman & Co property. The schematic and any adjoining information must not be made accessible to representatives of other companies without our permission

Revision	2	Product	HVCP Std 45kW Insight
Status	Available		
Date of approval	-	Date of created	2020-03-25
Approval by	-	Author	FRALE
233	previous page		

Nederman

PLC OUTPUT
TERMINALS

Drawing no.
2183626

Page no.
238
Next page 239

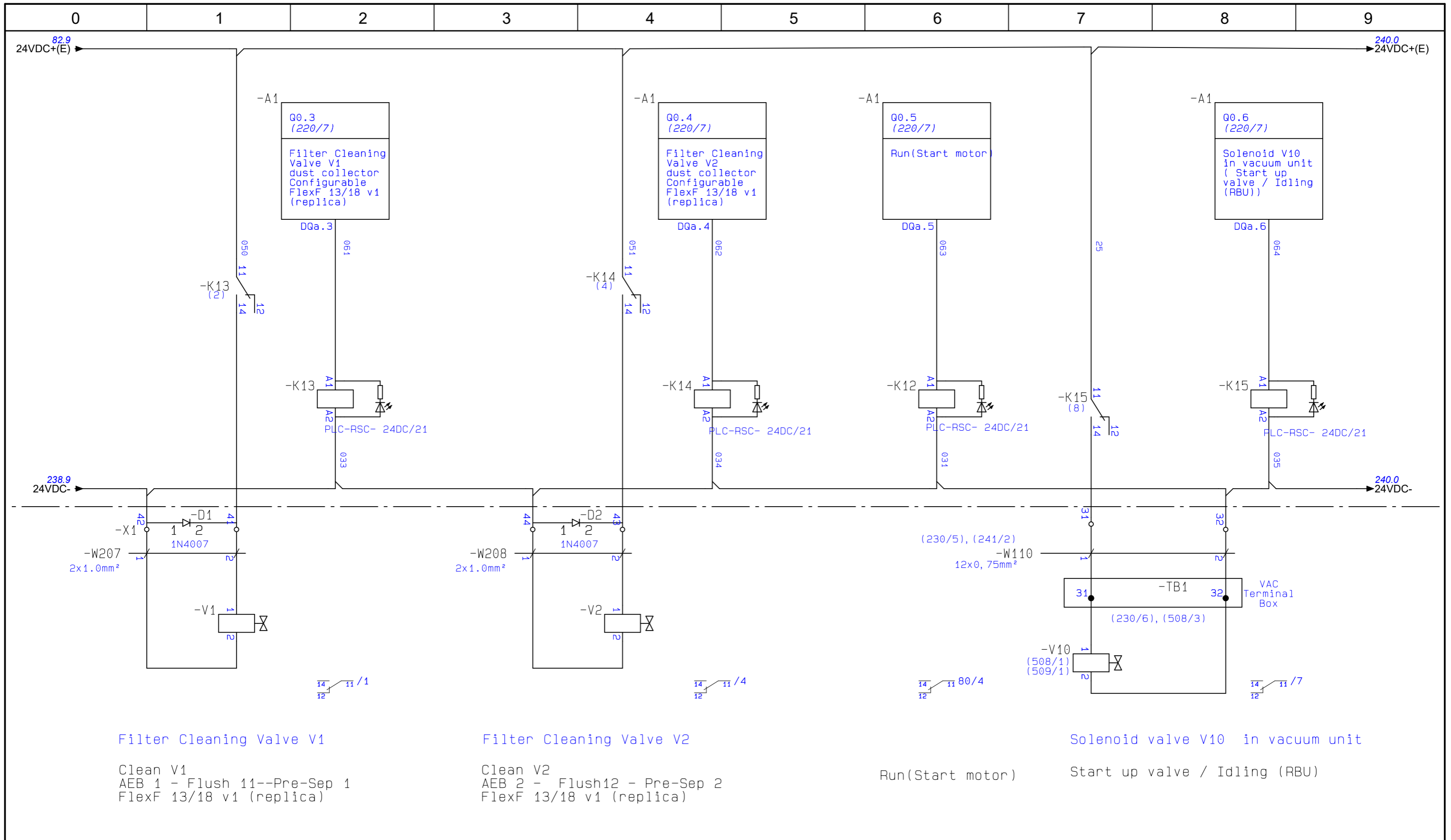

Filter Cleaning Valve V1

Clean V1
 AEB 1 - Flush 11--Pre-Sep 1
 FlexF 13/18 v1 (replica)

Filter Cleaning Valve V2

Clean V2
 AEB 2 - Flush12 - Pre-Sep 2
 FlexF 13/18 v1 (replica)

Run(Start motor)

Solenoid valve V10 in vacuum unit

Start up valve / Idling (RBU)

This schematic is AB Ph. Nederman & Co property. The schematic and any adjoining information must not be made accessible to representatives of other companies without our permission

Revision	2	Product	Product
Status	Available	Product	Product
Date of approval	-	Product	Product
Approval by	-	Date of created	2020-03-25
238	previous page	Author	FRALE



PLC OUTPUT
 TERMINALS

Drawing no.
 2183626

Page no.
 239
 Next page 240

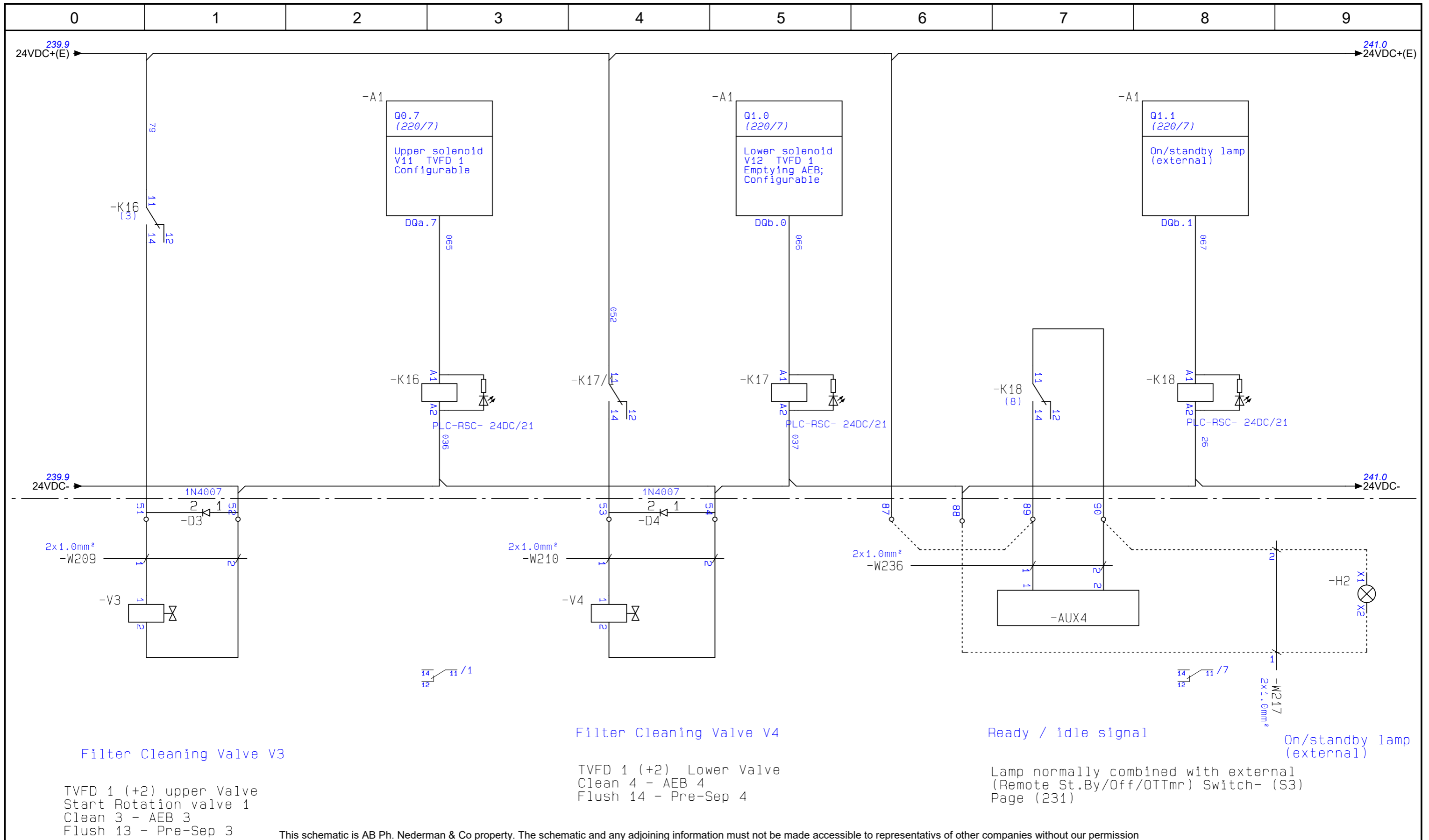

Revision	2	Product	Product
Status	Available	Product	HVCP Std 45kW Insight
Date of approval	-	Date of created	2020-03-25
Approval by	-	Author	FRALE
239	previous page		



PLC OUTPUT
TERMINALS

Drawing no.
2183626

Page no.
240
Next page 241

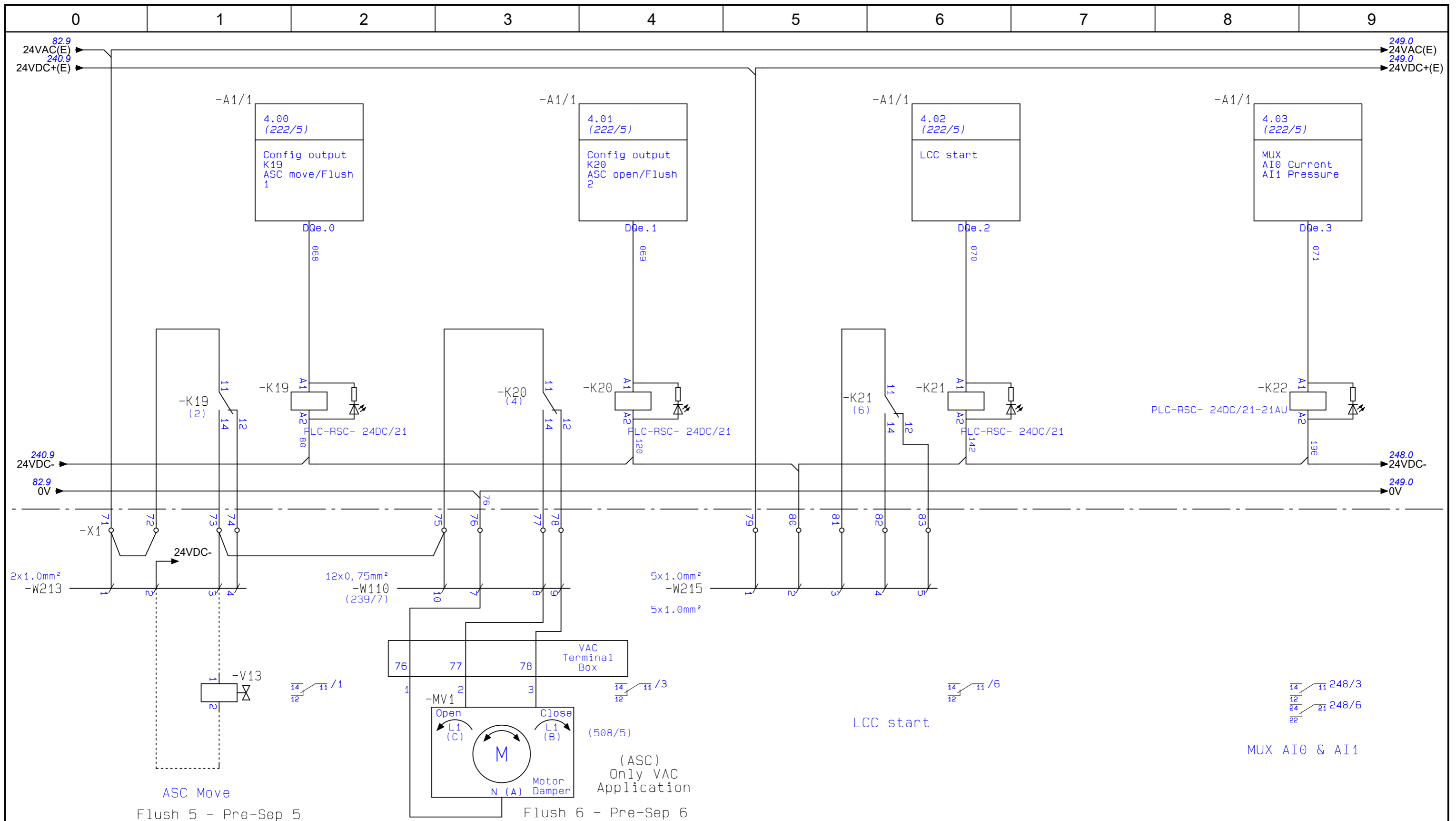

This schematic is AB Ph. Nederman & Co property. The schematic and any adjoining information must not be made accessible to representatives of other companies without our permission

Revision	2	Product	Product
Status	Available	Product	HVCP Std 45kW Insight
Date of approval	-	Date of created	2020-03-25
Approval by	-	Author	FRALE
240	previous page		

Nederman

SB1222 OUTPUT

Drawing no.
2183626

Page no.
241
Next page 248

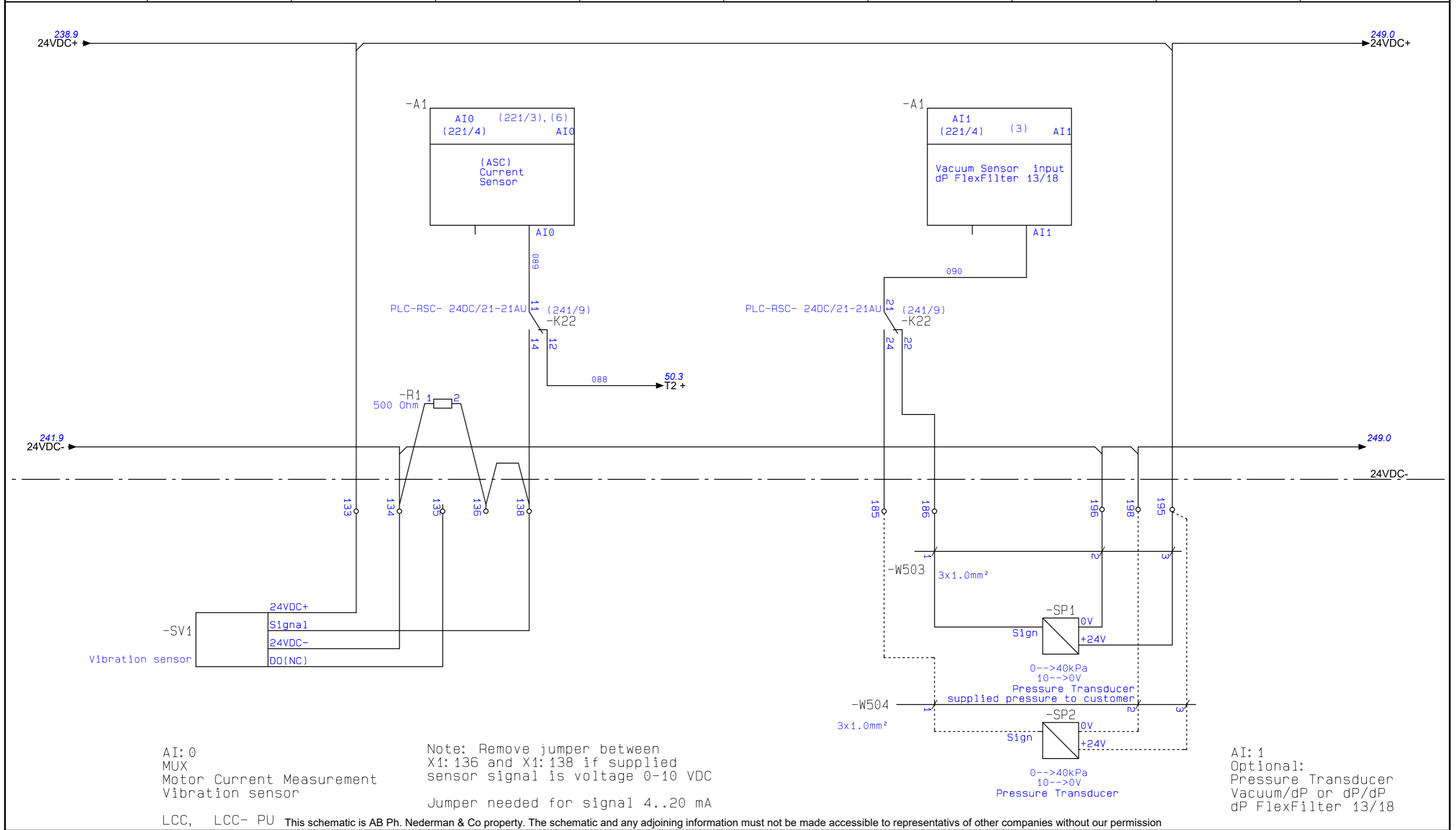

AI: 0
 MUX
 Motor Current Measurement
 Vibration sensor

Note: Remove jumper between
 X1: 136 and X1: 138 if supplied
 sensor signal is voltage 0-10 VDC
 Jumper needed for signal 4..20 mA

AI: 1
 Optional:
 Pressure Transducer
 Vacuum/dP or dP/dP
 dP FlexFilter 13/18

LCC, LCC- PU This schematic is AB Ph. Nederman & Co property. The schematic and any adjoining information must not be made accessible to representatives of other companies without our permission

Revision	2	Product	HVCP Std 45kW Insight
Status	Available	Date of created	2020-03-25
Date of approval	-	Author	FRALE
Approval by	-		
241	previous page		



PLC 0-10V DC
 ANALOGUE
 INPUT

Drawing no.
2183626

Page no.
248
 Next page 249

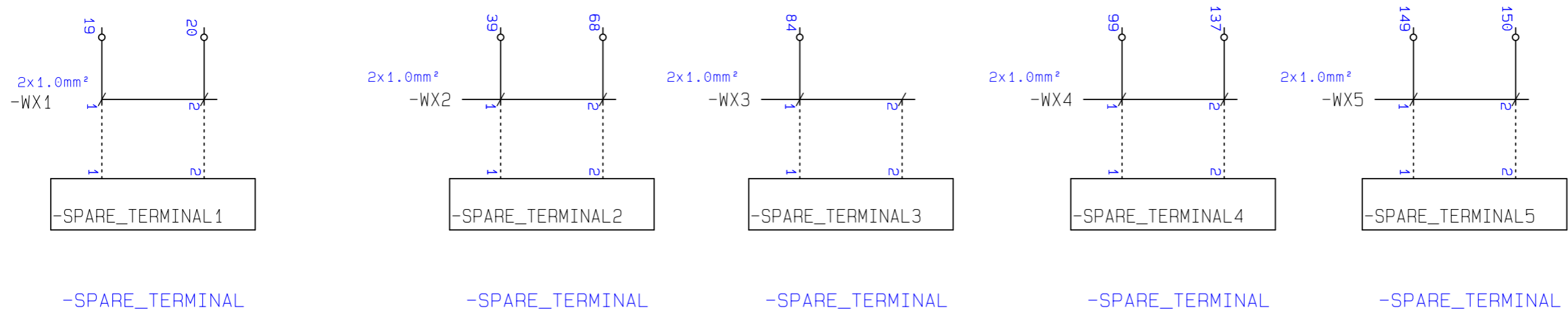
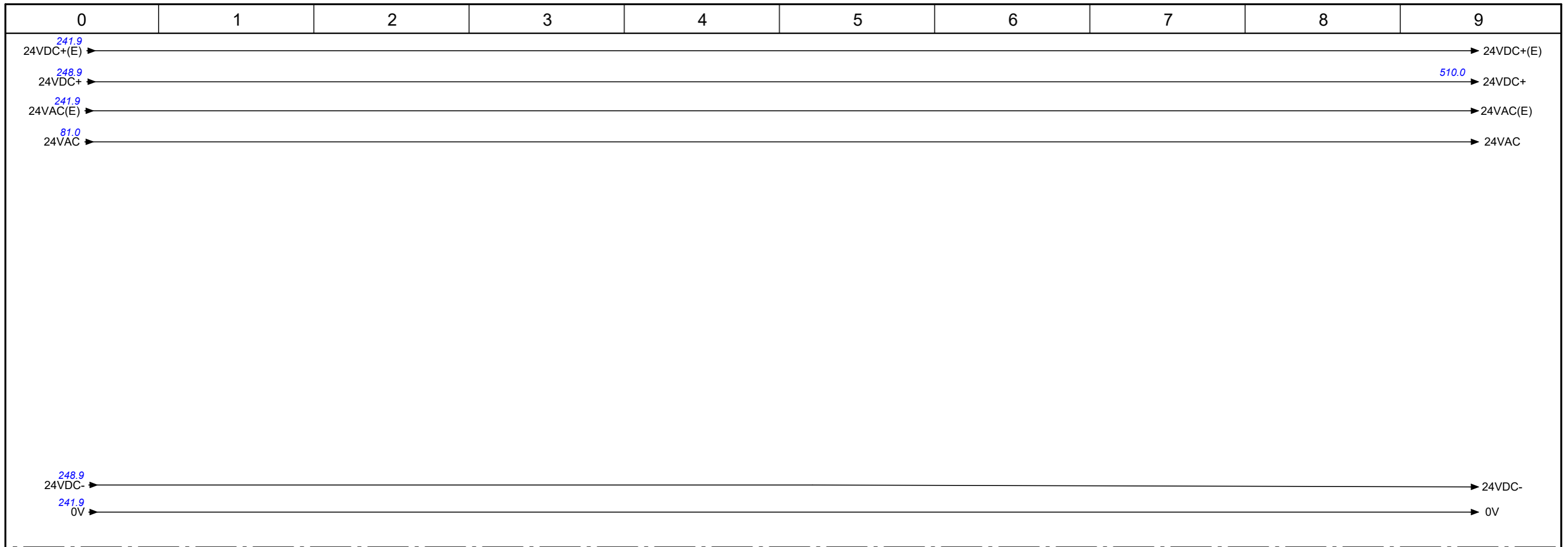

This schematic is AB Ph. Nederman & Co property. The schematic and any adjoining information must not be made accessible to representatives of other companies without our permission

Revision	2	Product	<h1 style="color:blue; margin:0;">Nederman</h1>		Spare Terminal	Drawing no.	Page no.	
Status	Available	HVCP Std 45kW Insight				2183626	249	
Date of approval	-	Date of created			2020-03-25			
Approval by	-	Author			FRALE			
248	previous page					Next page	500	

0	1	2	3	4	5	6	7	8	9
---	---	---	---	---	---	---	---	---	---

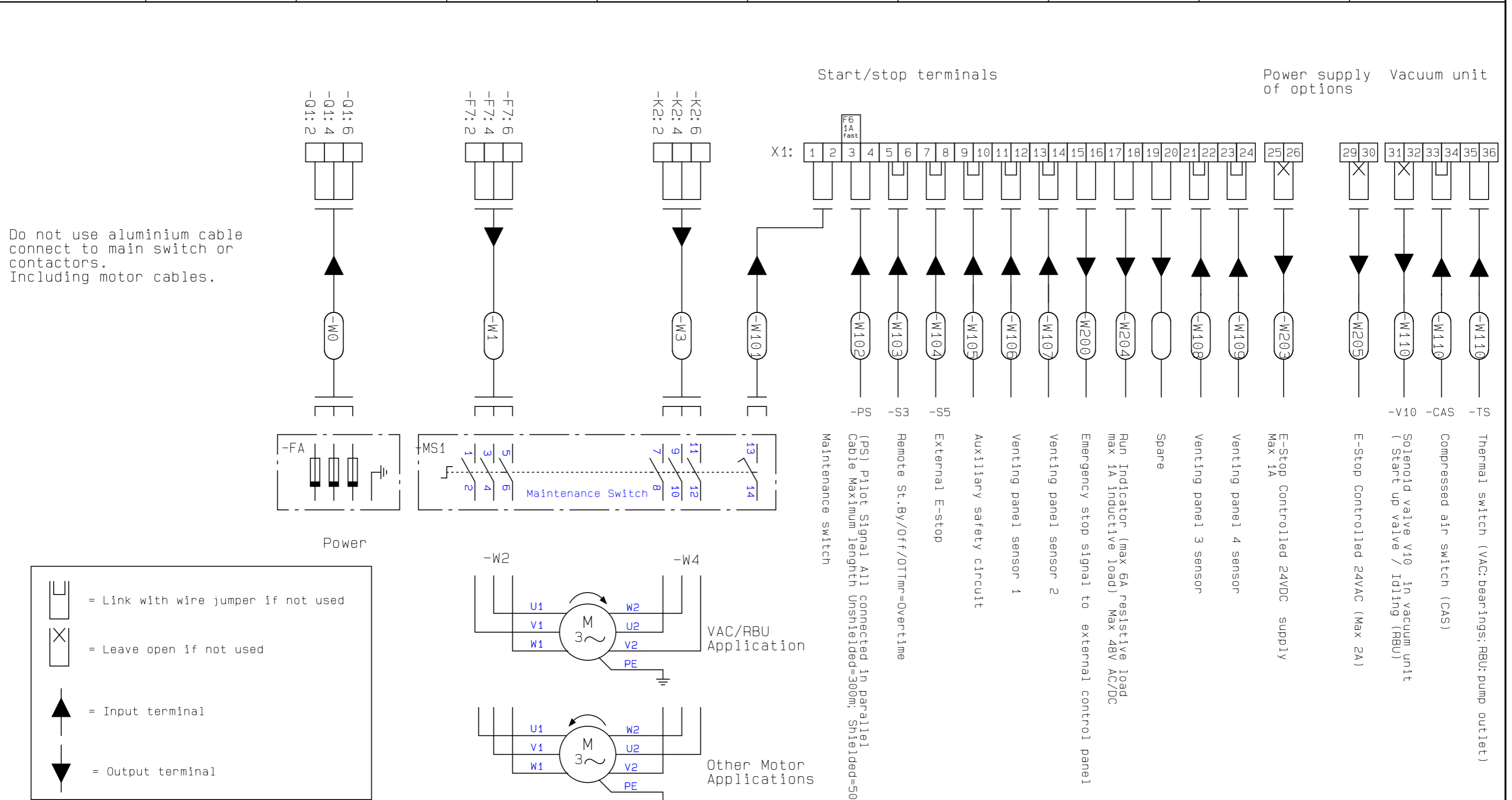

Do not use aluminium cable connect to main switch or contactors. Including motor cables.

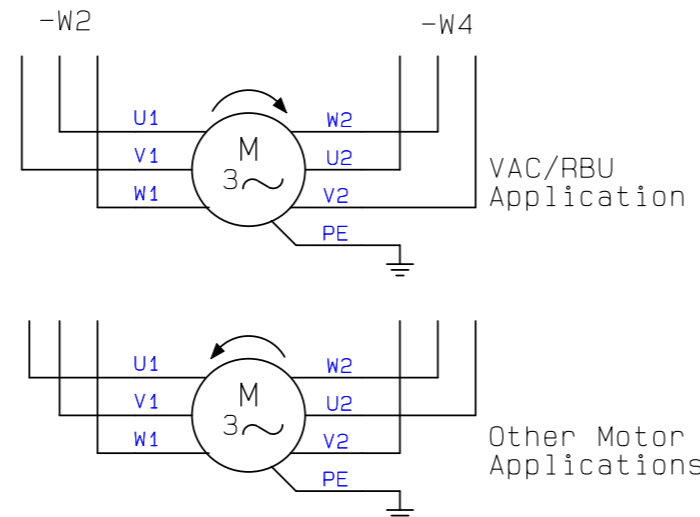
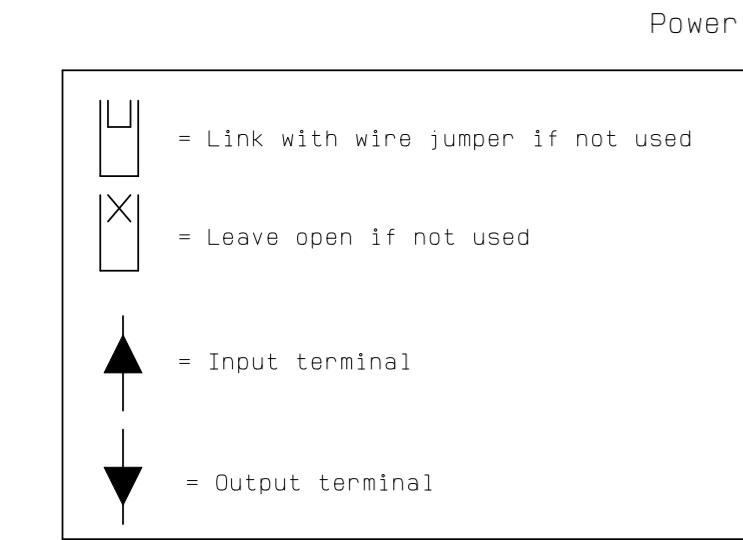
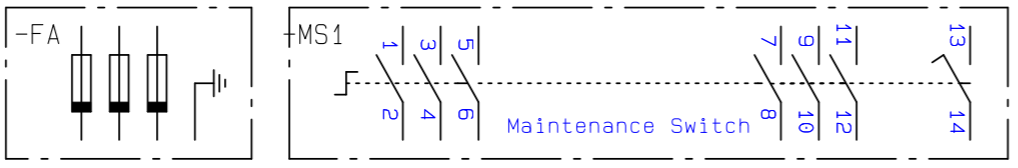

Note1: For terminals: use minimum 1.5mm² if cable is up to 10m long, and use minimum 2.5mm² if cable is up to 20m long, large area if cable is longer. small area in a 24V system can cause a poor short-cut protection

Note2: Check tightening of all power cable connections inside enclosure before putting into service.

This schematic is AB Ph. Nederman & Co property. The schematic and any adjoining information must not be made accessible to representatives of other companies without our permission

Revision	2	Product	HVCP Std 45kW Insight
Status	Available	Date of created	2020-03-25
Date of approval	-	Author	FRALE
Approval by	-		
249	previous page		



**STARTER
EXTERNAL
CONNECTIONS**

Drawing no.
2183626

Page no.
500
Next page 501

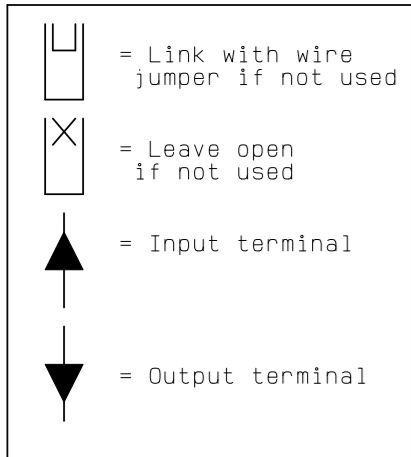
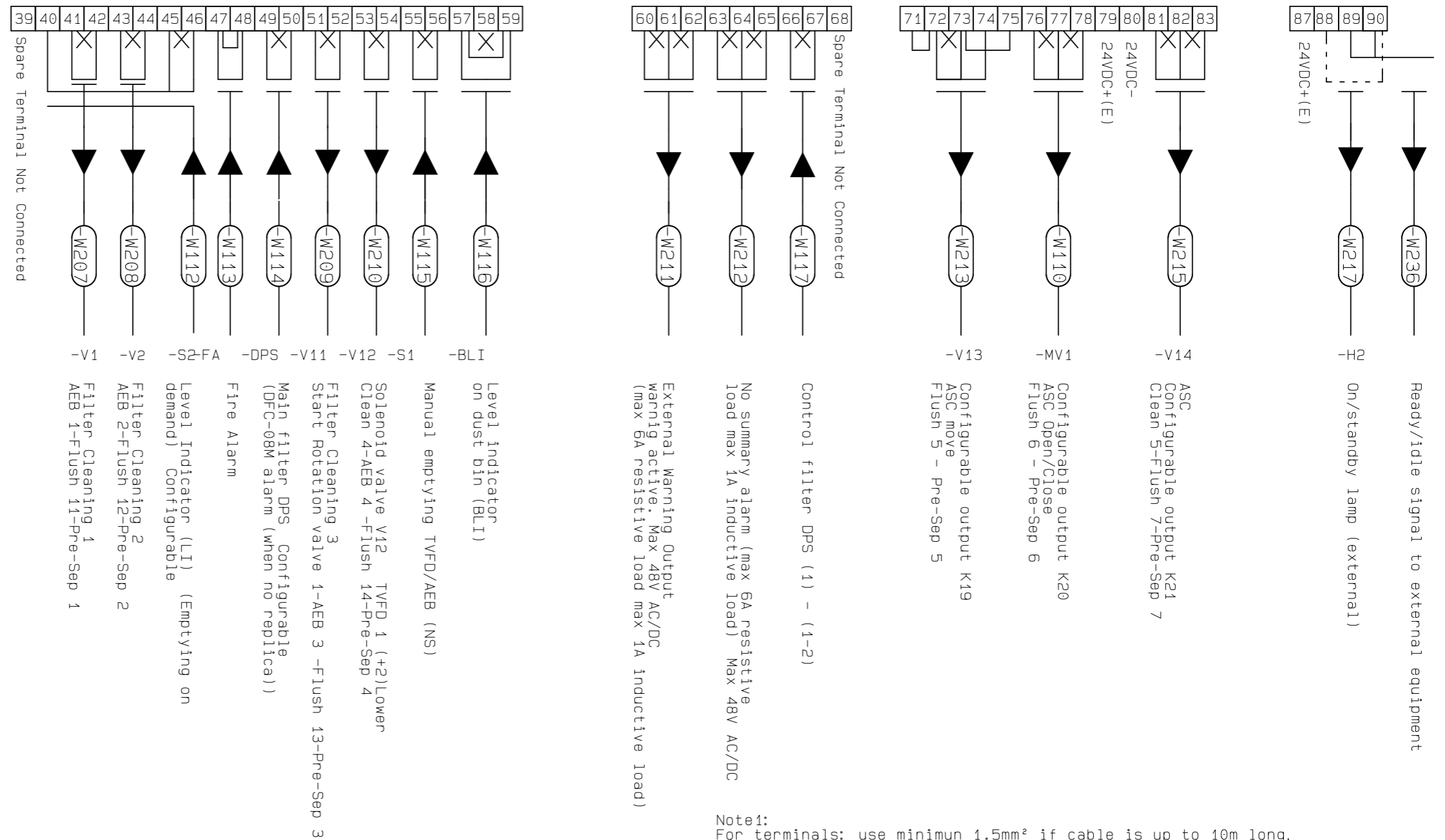

Note1:
For terminals: use minimum 1.5mm² if cable is up to 10m long, and use minimum 2.5mm² if cable is up to 20m long, large area if cable is longer. small area in a 24V system can cause a poor short-cut protection

Note2:
Never link terminals 35-36 if vacuum unit is fitted with a thermal fuse/switch, guarantee is void if overheat protection is set out of function.

Note3:
Check tightening of all power cable connections inside enclosure before putting into service.

This schematic is AB Ph. Nederman & Co property. The schematic and any adjoining information must not be made accessible to representatives of other companies without our permission

99	101
----	-----

Spare Terminal Not Connected

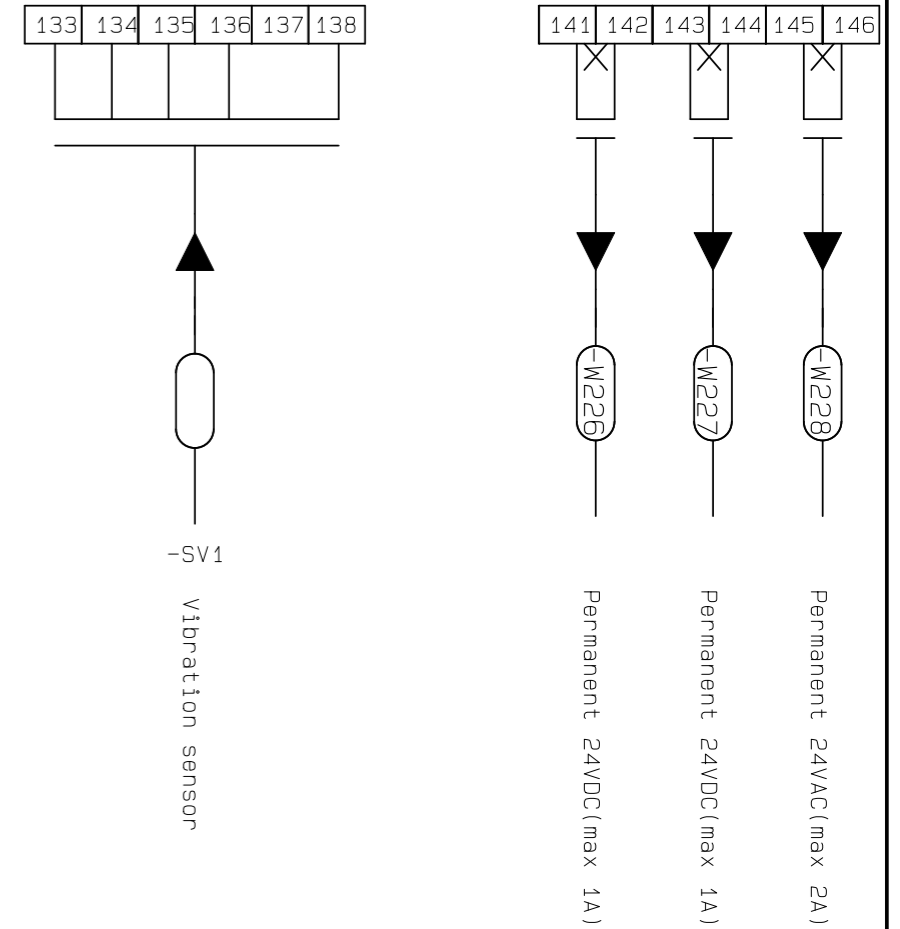

Note1:
For terminals: use minimum 1.5mm² if cable is up to 10m long, and use minimum 2.5mm² if cable is up to 20m long, larger area if cable is longer. small area in a 24V system can cause a poor short-circuit protection

Note2:
Never link terminals 35-36 if vacuum unit is fitted with a thermal fuse/switch, guarantee is void if overheat protection is set out of function.

Note3:
Check tightening of all power cable connections inside enclosure before putting into service.

This schematic is AB Ph. Nederman & Co property. The schematic and any adjoining information must not be made accessible to representatives of other companies without our permission

Revision	2	Product	HVCP Std 45kW Insight
Status	Available	Date of created	2020-03-25
Date of approval	-	Author	FRALE
Approval by	-		
501	previous page		



**STARTER
EXTERNAL
CONNECTIONS**

Drawing no.
2183626

Page no.
502
Next page 503

0	1	2	3	4	5	6	7	8	9
---	---	---	---	---	---	---	---	---	---

149 150 151

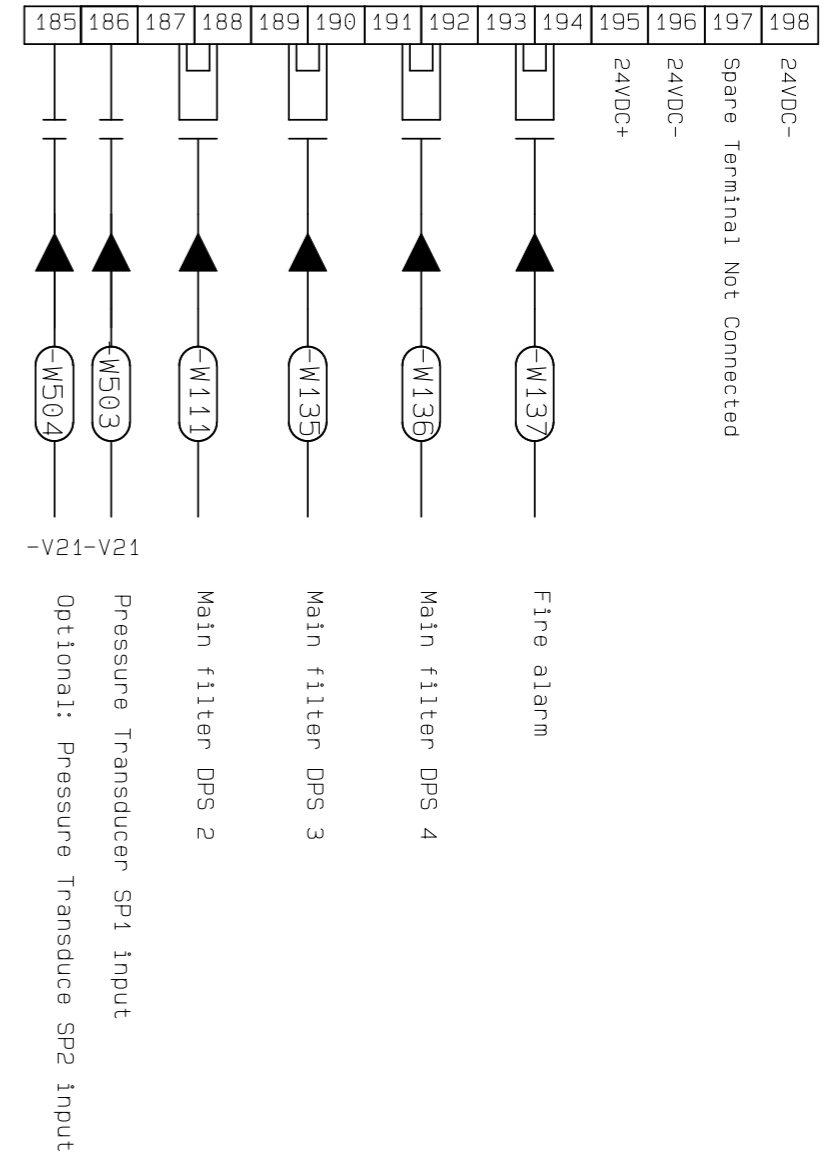

Note1:
For terminals: use minimum 1.5mm² if cable is up to 10m long, and use minimum 2.5mm² if cable is up to 20m long, large area if cable is longer. Small area in a 24V system can cause a poor short-cut protection

Note2:
Never link terminals 34-35 if vacuum unit is fitted with a thermal fuse/switch, guarantee is void if overheat protection is set out of function.

Note3:
Check tightening of all power cable connections inside enclosure before putting into service.

This schematic is AB Ph. Nederman & Co property. The schematic and any adjoining information must not be made accessible to representatives of other companies without our permission

Revision	2	Product	HVCP Std 45kW Insight
Status	Available	Date of created	2020-03-25
Date of approval	-	Author	FRALE
Approval by	-		
502	previous page		

Nederman

**STARTER
EXTERNAL
CONNECTIONS**

Drawing no.
2183626

Page no.
503

Next page 504

Load Current Control (LCC) be cotrolled by PLC and E-stop interlock wiring

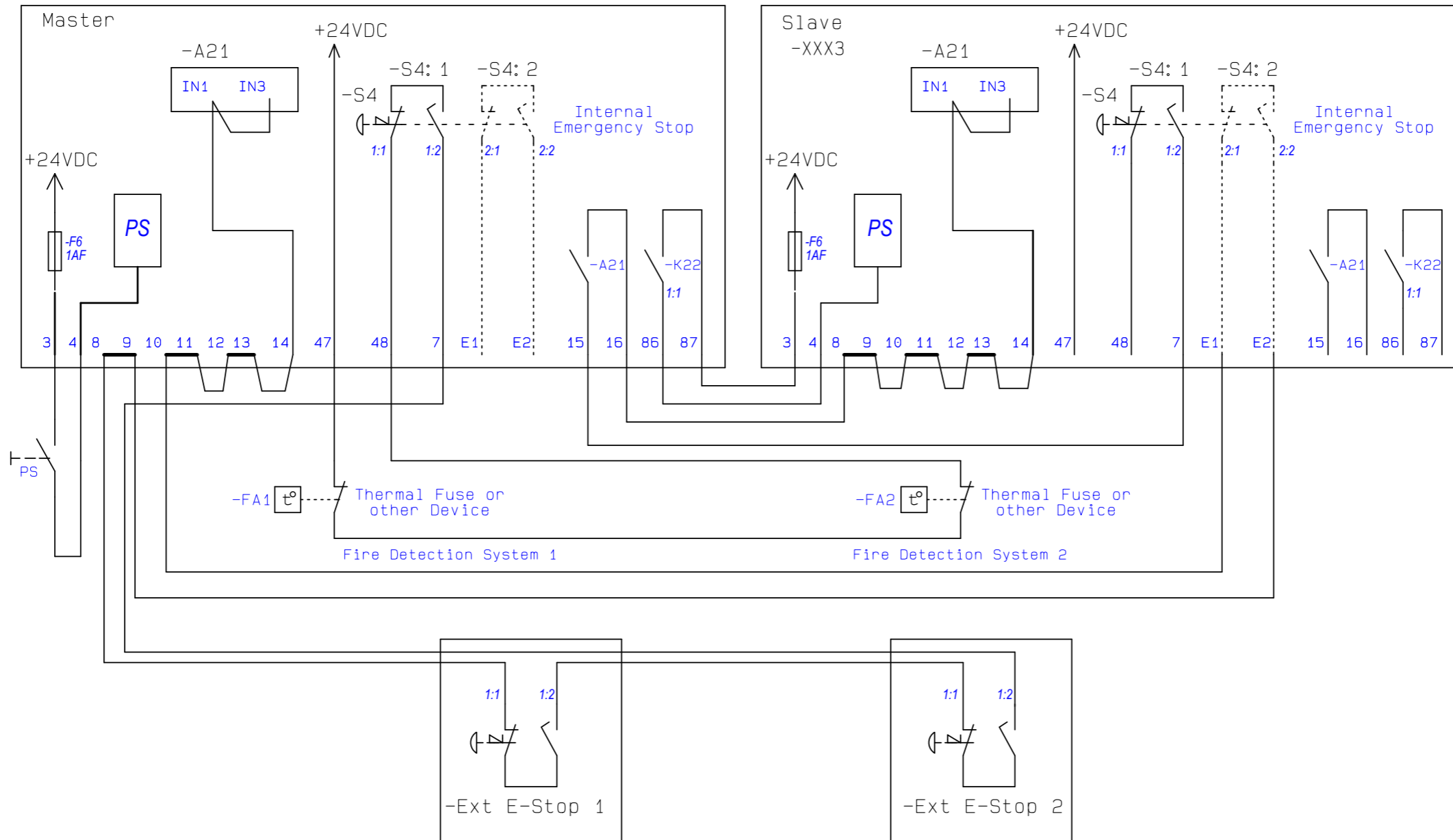

N.B
If masterunit is powered of or out of
comission the Slave will not start

Double E-Stop switch S4
Block S4:2 and The terminal E1 and E2
Are not included in the Cabinet

This schematic is AB Ph. Nederman & Co property. The schematic and any adjoining information must not be made accessible to representativs of other companies without our permission

Revision	2	Product	HVCP Std 45kW Insight	
Status	Available			
Date of approval	-			
Approval by	-	Date of created	2020-03-25	
503	previous page	Author	FRALE	



OPTIONAL
CONNECTIONS
MASTER-SLAVE

Drawing no.
2183626

Page no.
504
Next page 505

Load Current Control (LCC) be cotrolled by PLC and E-stop interlock wiring

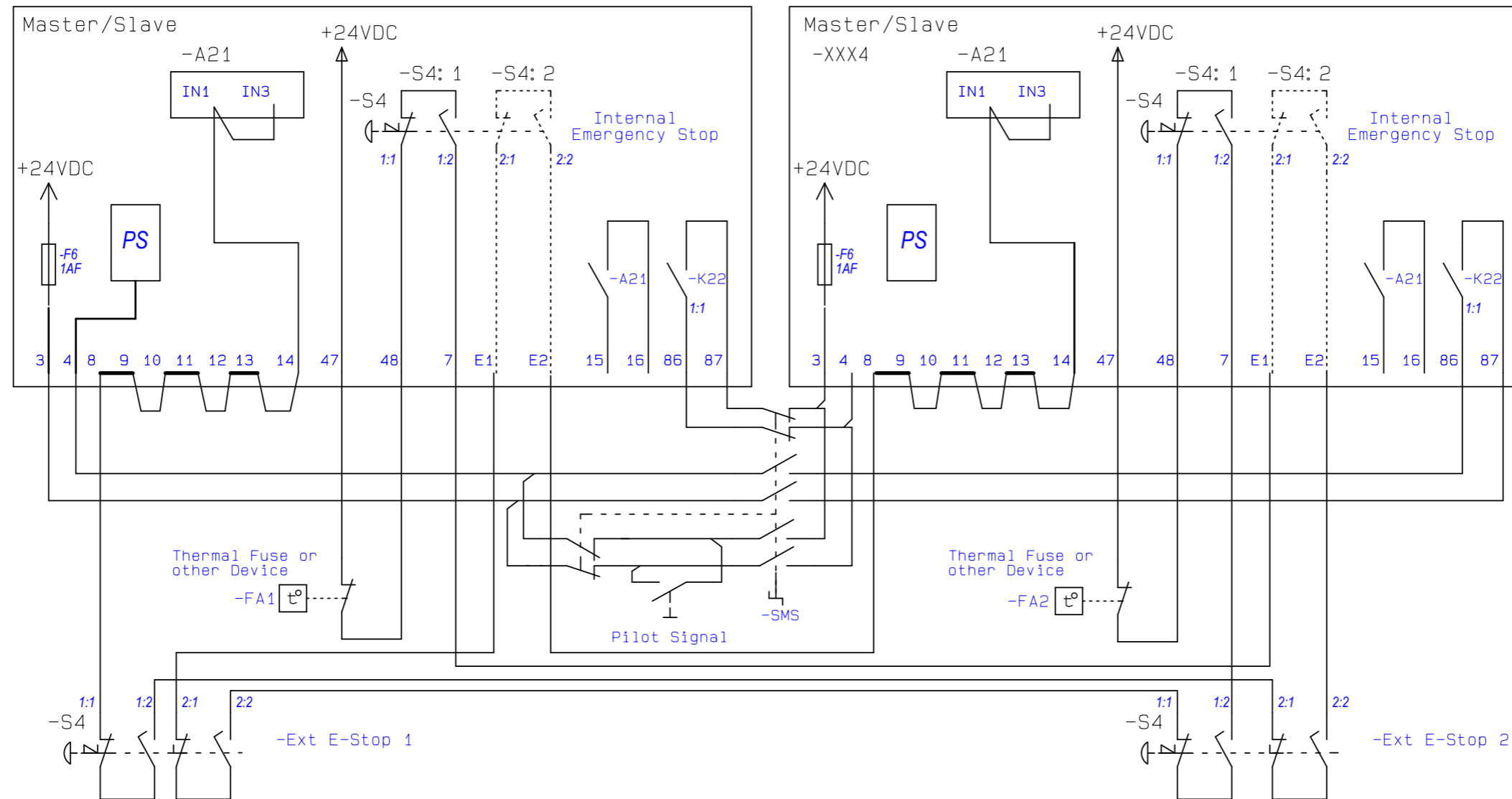

N.B
SMS Switches to select wich unit is Master or Slave
Both system can run individually even if the other is
off or out of commissioning

N.B
Double E-Stop switch S4
Block S4:2 and The terminal E1 and E2
Are not included in the Cabinet

N.B
SMS Switch is not avvabile as a Nederman part

This schematic is AB Ph. Nederman & Co property. The schematic and any adjoining information must not be made accessible to representativs of other companies without our permission

Revision	2	Product	HVCP Std 45kW Insight	
Status	Available	Date of created	2020-03-25	
Date of approval	-	Author	FRALE	
Approval by	-			
504	previous page			



OPTIONAL
CONNECTIONS
MASTER-SLAVE

Drawing no.
2183626

Page no.
505
Next page 508

Connection of anti surge control (ASC) to starter
 ASC be controlled by PLC, Current sensor connect to PLC AI0

Principal schematic Multiple BLI or LI
 Used sensor (EX sensors with relay output)

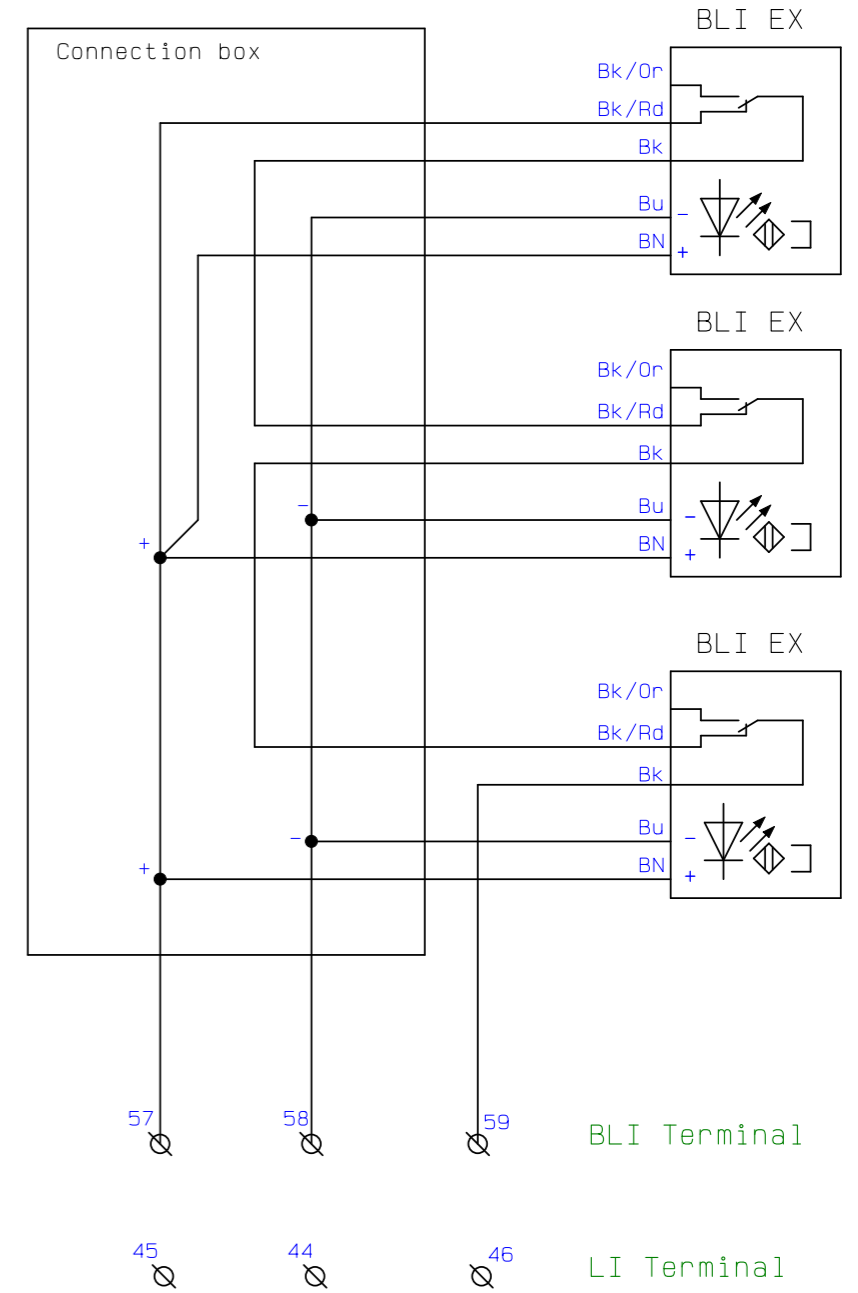
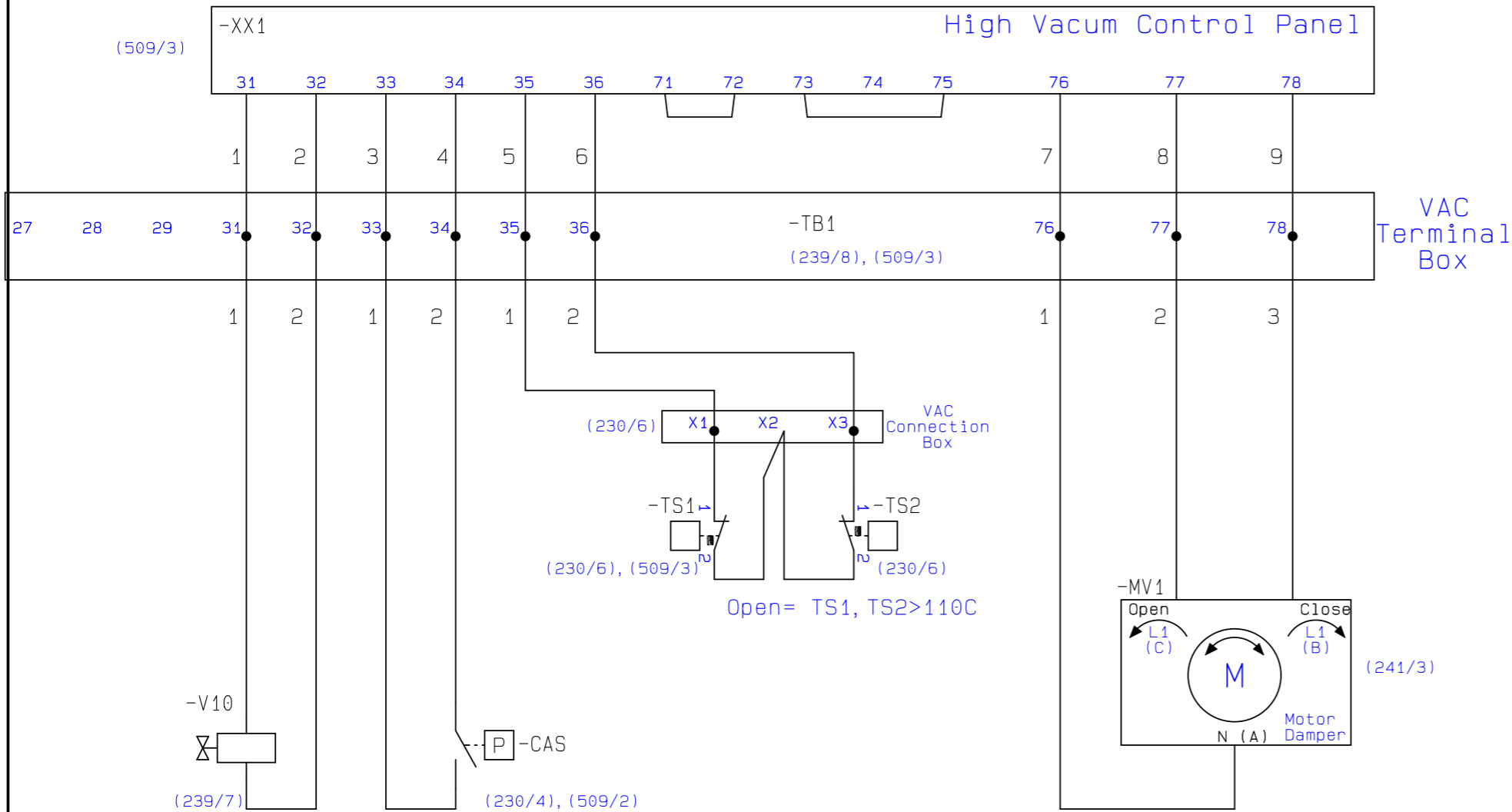

START UPP VALVE (239/7) (CAS) Open = P<3Bar (230/4), (509/2) Thermal Supervision VAC- Fan Shaft Bearings (230/6), (509/3) (ASC) Only VAC Application (241/3)

This schematic is AB Ph. Nederman & Co property. The schematic and any adjoining information must not be made accessible to representatives of other companies without our permission

Revision	2	Product	Product
Status	Available	HVCP Std 45kW Insight	
Date of approval	-	Date of created	2020-03-25
Approval by	-	Author	FRALE
505	previous page		



VAC ASC CONNECTIONS and OPTIONAL BLI

Drawing no. 2183626

Page no. 508
 Next page 509

Connection of HVAC to RBU Unit

Principal schematic Multiple BLI or LI
Used sensor (EX sensors with relay output)

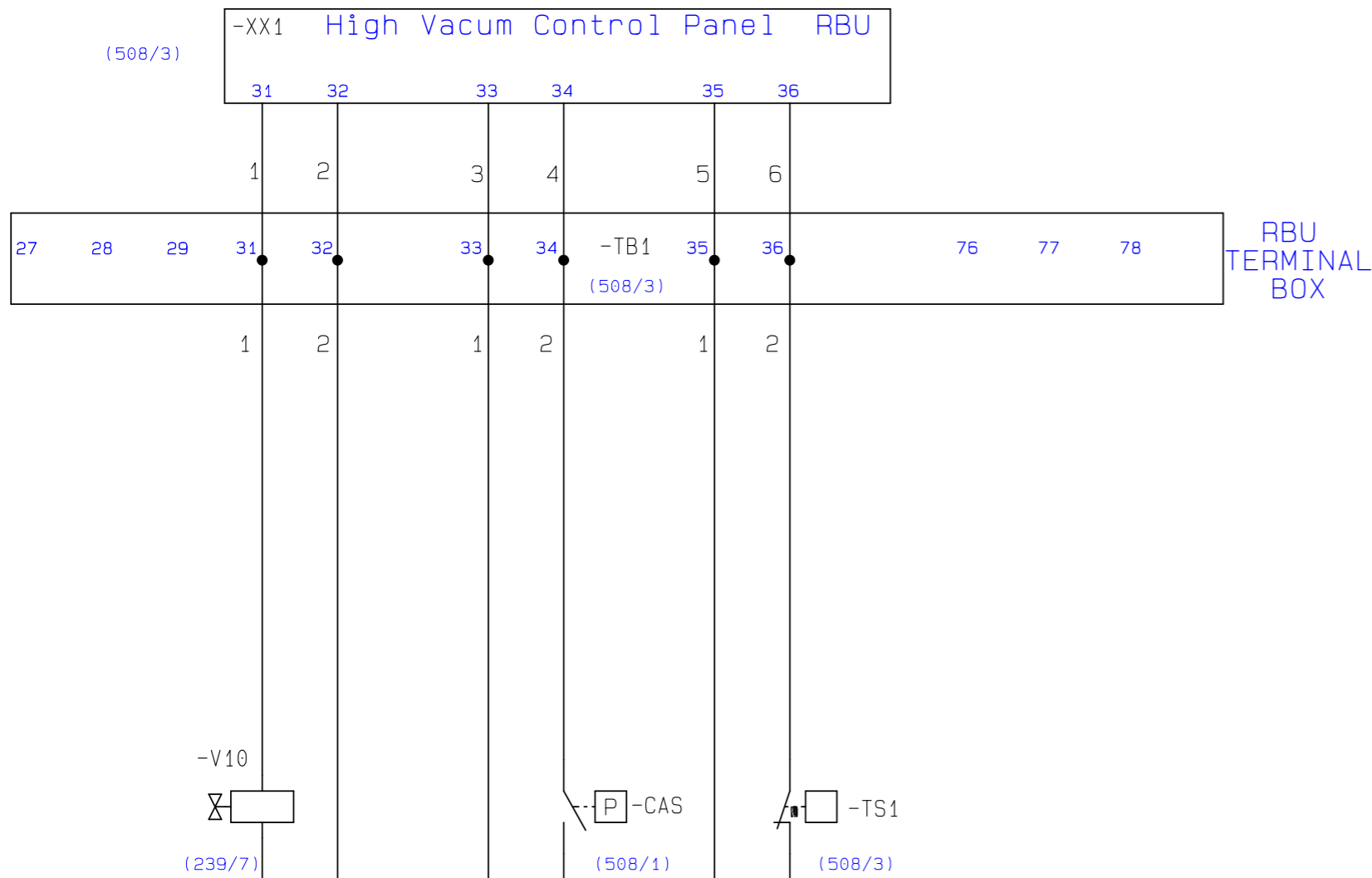

Open = TS1>140C
Not Resettable

START
UPP VALVE

(CAS)
Open = P<3Bar

Thermal Supervision
RBU- Air Outlet

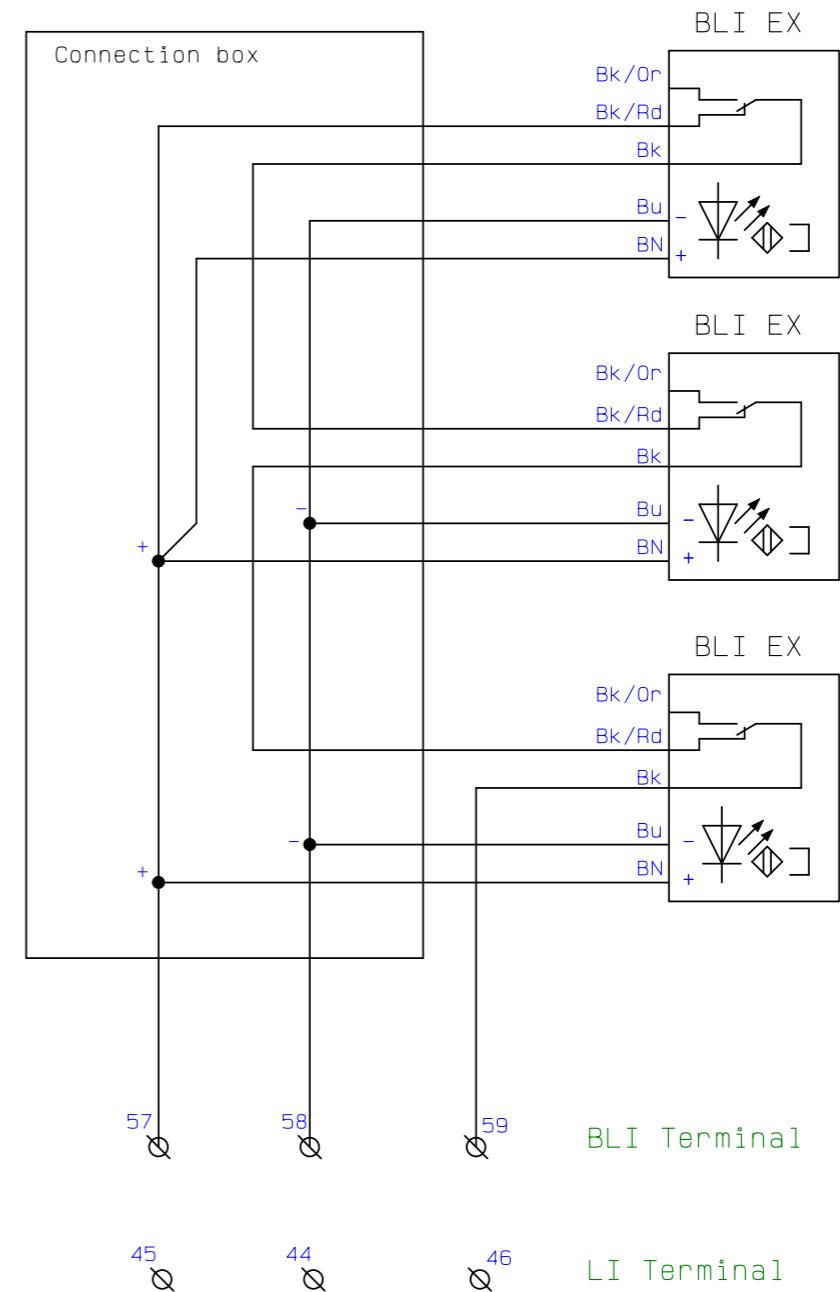

This schematic is AB Ph. Nederman & Co property. The schematic and any adjoining information must not be made accessible to representatives of other companies without our permission

Revision	2	Product	Product
Status	Available	HVCP Std 45kW Insight	
Date of approval	-	Date of created	2020-03-25
Approval by	-	Author	FRALE
508	previous page		



RBU
CONNECTIONS
and OPTIONAL BLI

Drawing no.
2183626

Page no.
509
Next page 510

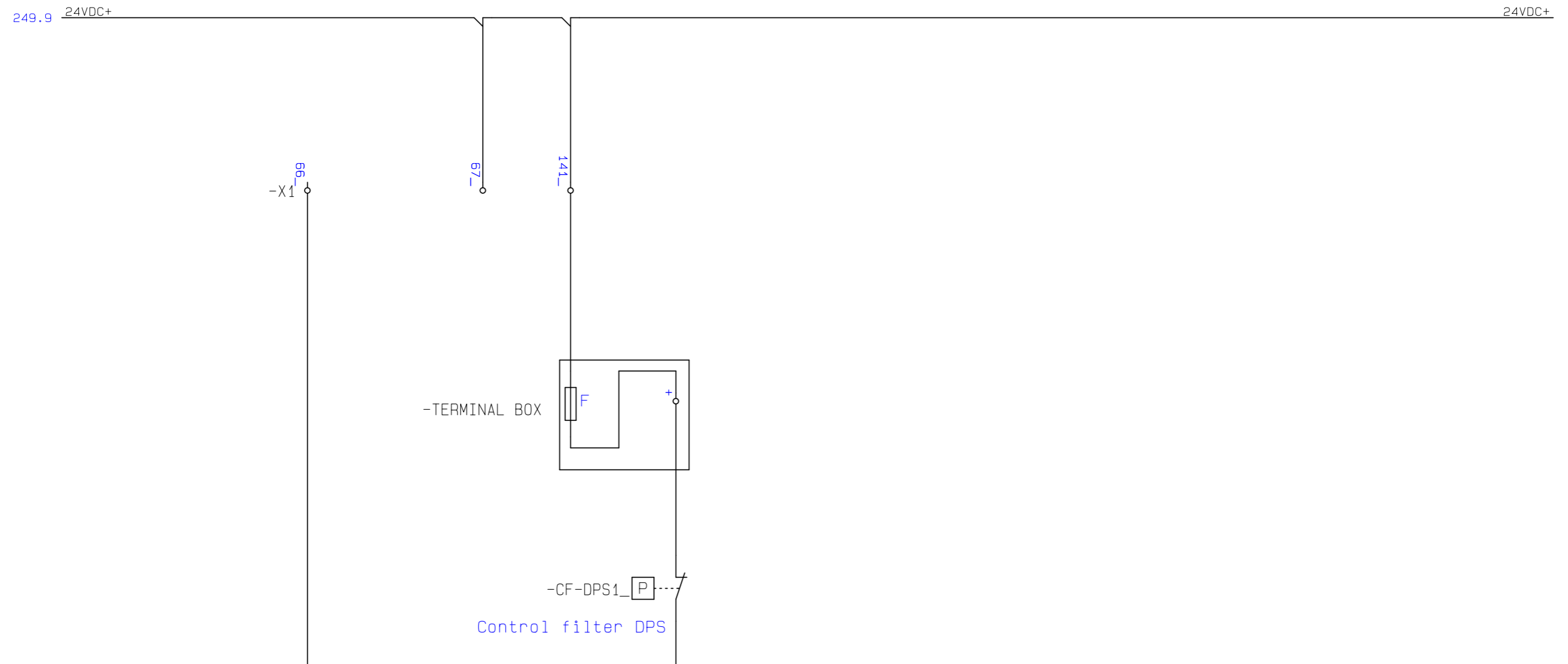

Principal schematic, connection of sensors using auxiliary connection box.

With sensors connected via auxiliary connection devices the schematic supplied with the auxiliary equipment is governing.

In the displayed example the DPS is connected via the terminal box instead of X1:67.

This schematic is AB Ph. Nederman & Co property. The schematic and any adjoining information must not be made accessible to representatives of other companies without our permission

Revision	2	Product	<h1 style="margin:0;">Nederman</h1>		SENSORS VIA AUXILIARY CONNECTION BOX	Drawing no. 2183626	Page no. 510
Status	Available	HVCP Std 45kW Insight			Next page	1000	
Date of approval	-	Date of created	2020-03-25				
Approval by	-	Author	FRALE				
509	previous page						

Lists

Nederman

No.	Name	EAN-no.	Type	Description	Manufacture	Ref. position	Remarks
1			800F-X01S			70/3	
2	-A1		6ES7214-1AG31-0XB0			248/3	Optional
3	-A1/1		6ES7222-1BD30-0XB0			10/4	
4	-A2		6ES7223-1BH30-0XB0			200/8	*
5	-A11		6AV6647-0AA11-3AX0			9/4	*
6	-A21		3SK1111-1AB30			10/4	*
7	-AUX1					82/2	*
8	-AUX2					232/4	*
9	-AUX3					82/6	*
10	-AUX4					240/7	*
11	-AUX- E-STOP					71/6	*
12	-AUX-SAFE1					70/5	*
13	-AUX-SAFE2					70/6	*
14	-AUX-SAFE3					70/7	*
15	-AUX-SAFE4					70/8	*
16	-AUX-SAFE5					70/9	*
17	-BLI (EX)					231/2	*
18	-D1		1N4007			239/1	*
19	-D2		1N4007			239/3	*
20	-D3		1N4007			240/1	*
21	-D4		1N4007			240/4	*
22	-E1		Rital AE 600x600x250			10/4	*
23	-E2		Cable channel 360X25X80			10/5	*
24	-E3		Cable channel 380X25X80			10/4	*
25	-E4		Cable channel 295X40X80			10/5	*
26	-E5		Cable channel 405X40X80			10/6	*
27	-E6		Cable channel 360X40X80			10/5	*
28	-E01		550x550mm			10/4	*

* Use of components with equivalent electric, mechanical and approval specifications is acceptable

This schematic is AB Ph. Nederman & Co property. The schematic and any adjoining information must not be made accessible to representatives of other companies without our permission

Revision	2	Product	HVCP Std 45kW Insight			COMPONENT LIST	Drawing no.	Page no.
Status	Available	Date of created	2020-03-25	2183626			1001	
Date of approval	-	Author	FRALE					
Approval by	-	1000	Previous page	Next page			1002	

No.	Name	EAN-no.	Type	Description	Manufacture	Ref. position	Remarks
29	-EBR					10/3	*
30	-ET1		UK 2,5 N			210/7	*
31	-EXT ALARM					238/1	*
32	-EXT WARNING					238/6	*
33	-F2		140M-C2E-B16			10/5	*
34	-F4		Fuse 5X20m 4A Slow			60/2	*
35	-F4		Fuse 5X20m 4A Slow			10/6	*
36	-F5		Fuse 5X20mm 6,3A Slow			60/3	*
37	-F6		1A 5x20mm fast			230/1	*
38	-F6		WK 4 TKG/U/V0			10/4	*
39	-F7		193-EEGE			10/2	*
40	-FA1		(Thermal Fuse or other device)			70/1	*
41	-FA2		(Thermal Fuse or other device)			70/0	*
42	-H1		800FP-P5PN3Y			238/5	*
43	-H2					240/9	*
44	-K1		100-FA11			70/6	*
45	-K1		100-C60KJ00			10/2	*
46	-K1		100-FA11			10/2	*
47	-K1		100-FA11			80/8	*
48	-K2		100-C60KJ00			10/3	*
49	-K2		100-FA22			10/3	*
50	-K3		100-C37KJ00			10/3	*
51	-K3		100-FA02			10/3	*
52	-K4T		700-FSY2DU23			80/8	*
53	-K8		PLC-RSC- 24DC/21-21			238/3	*
54	-K8		PLC-RSC- 24DC/21-21			10/5	*
55	-K9		PLC-RSC- 24DC/21			70/2	*
56	-K9		PLC-RSC- 24DC/21			10/5	*

* Use of components with equivalent electric, mechanical and approval specifications is acceptable

This schematic is AB Ph. Nederman & Co property. The schematic and any adjoining information must not be made accessible to representatives of other companies without our permission

Revision	2	Product	HVCP Std 45kW Insight			COMPONENT LIST	Drawing no.	Page no.
Status	Available			2183626			1002	
Date of approval	-	Date of created	2020-03-25					
Approval by	-	Author	FRALE					
1001	Previous page			Next page 1003				

No.	Name	EAN-no.	Type	Description	Manufacture	Ref. position	Remarks
57	-K10		PLC-RSC- 24DC/21			238/2	*
58	-K10		PLC-RSC- 24DC/21			10/5	*
59	-K11		PLC-RSC- 24DC/21			238/8	*
60	-K11		PLC-RSC- 24DC/21			10/5	*
61	-K12		PLC-RSC- 24DC/21			239/6	*
62	-K12		PLC-RSC- 24DC/21			10/5	*
63	-K13		PLC-RSC- 24DC/21			239/2	*
64	-K13		PLC-RSC- 24DC/21			10/5	*
65	-K14		PLC-RSC- 24DC/21			239/4	*
66	-K14		PLC-RSC- 24DC/21			10/5	*
67	-K15		PLC-RSC- 24DC/21			239/8	*
68	-K15		PLC-RSC- 24DC/21			10/5	*
69	-K16		PLC-RSC- 24DC/21			240/3	*
70	-K16		PLC-RSC- 24DC/21			10/5	*
71	-K17		PLC-RSC- 24DC/21			240/5	*
72	-K17		PLC-RSC- 24DC/21			10/5	*
73	-K17/1		PLC-RSC- 24DC/21			240/4	*
74	-K18		PLC-RSC- 24DC/21			240/8	*
75	-K18		PLC-RSC- 24DC/21			10/5	*
76	-K19		PLC-RSC- 24DC/21			241/2	*
77	-K19		PLC-RSC- 24DC/21			10/5	*
78	-K20		PLC-RSC- 24DC/21			241/4	*
79	-K20		PLC-RSC- 24DC/21			10/6	*
80	-K21		PLC-RSC- 24DC/21			241/6	*
81	-K21		PLC-RSC- 24DC/21			10/6	*
82	-K22		PLC-RSC- 24DC/21-21AU			10/6	*
83	-LI (EX)					232/9	*
84	-MV1					241/3	*

* Use of components with equivalent electric, mechanical and approval specifications is acceptable

This schematic is AB Ph. Nederman & Co property. The schematic and any adjoining information must not be made accessible to representatives of other companies without our permission

Revision	2	Product	HVCP Std 45kW Insight			COMPONENT LIST	Drawing no.	Page no.
Status	Available			2183626			1003	
Date of approval	-	Date of created	2020-03-25					
Approval by	-	Author	FRALE					
1002	Previous page					Next page	1004	

No.	Name	EAN-no.	Type	Description	Manufacture	Ref. position	Remarks
85	-P1					210/9	*
86	-PE		WT 4 PE			60/6	*
87	-PTC-MOTOR		PTC Built in Monitoring overhe			80/1	*
88	-Q1		3LD2814-0TK51			10/3	*
89	-R1		500 Ohm			248/3	*
90	-S3		Switch NC			231/8	*
91	-S4		800FP-MT44			9/4	*
92	-S5		External E-stop 800FP-MT44			70/3	*
93	-SP1		0-->40kPa 10-->0V			248/7	*
94	-SP2		0-->40kPa 10-->0V			248/7	*
95	-SPARE_TERMINAL1					249/1	*
96	-SPARE_TERMINAL2					249/3	*
97	-SPARE_TERMINAL3					249/4	*
98	-SPARE_TERMINAL4					249/6	*
99	-SPARE_TERMINAL5					249/7	*
100	-SV1					248/1	*
101	-T1		Transformer 230-460V 24VAC/24VDC			10/6	*
102	-T1		Transfo 230-460V			60/2	*
103	-T2					10/3	*
104	-T2		Current Sensor LEM AT 100 B10			50/1	*
105	-TB1					230/6	*
106	-TERMINAL BOX					510/3	*
107	-U1		EWON FLEXY 205			10/4	*
108	-U1		eWon flexy205			210/7	*
109	-V1					239/1	*
110	-V2					239/4	*
111	-V3					240/1	*
112	-V4					240/4	*

* Use of components with equivalent electric, mechanical and approval specifications is acceptable

This schematic is AB Ph. Nederman & Co property. The schematic and any adjoining information must not be made accessible to representatives of other companies without our permission

Revision	2	Product	HVCP Std 45kW Insight			COMPONENT LIST	Drawing no.	Page no.
Status	Available			2183626			1004	
Date of approval	-	Date of created	2020-03-25					
Approval by	-	Author	FRALE					
1003	Previous page					Next page	1005	

No.	Name	EAN-no.	Type	Description	Manufacture	Ref. position	Remarks
113	-V10		START UPP VALVE			508/1	*
114	-W0		Power Cable			50/1	*
115	-W1		Motor Cable >= 3x10mm ² + PE			80/1	*
116	-W2		Motor Cable >= 3x10mm ² + PE			80/2	*
117	-W3		Motor Cable >= 3x10mm ² + PE			80/1	*
118	-W4		Motor Cable >= 3x10mm ² + PE			80/2	*
119	-W101		2x1.0mm ²			232/1	*
120	-W102		2x1.0mm ²			230/1	*
121	-W103		2x1.0mm ²			231/7	*
122	-W104		2x1.0mm ²			70/3	*
123	-W105		2x1.0mm ²			70/5	*
124	-W106		2x1.0mm ²			70/6	*
125	-W107		2x1.0mm ²			70/7	*
126	-W108		2x1.0mm ²			70/8	*
127	-W109		2x1.0mm ²			70/9	*
128	-W110		0,75mm ²			230/3	*
129	-W111		2x1.0mm ²			231/4	*
130	-W112		3x1,0mm ²			232/6	*
131	-W113		2x1.0mm ²			70/1	*
132	-W114		2x1.0mm ²			231/3	*
133	-W115		2x1.0mm ²			233/5	*
134	-W116		3x1.0mm ²			231/0	*
135	-W117		2x1.0mm ²			233/0	*
136	-W135		2x1.0mm ²			231/5	*
137	-W136		2x1.0mm ²			231/5	*
138	-W137		2x1.0mm ²			70/0	*
139	-W200		2x1.0mm ²			71/6	*
140	-W203		2x1.0mm ²			82/1	*

* Use of components with equivalent electric, mechanical and approval specifications is acceptable

This schematic is AB Ph. Nederman & Co property. The schematic and any adjoining information must not be made accessible to representatives of other companies without our permission

Revision	2	Product	HVCP Std 45kW Insight			COMPONENT LIST	Drawing no.	Page no.
Status	Available			2183626			1005	
Date of approval	-	Date of created	2020-03-25					
Approval by	-	Author	FRALE					
1004	Previous page			Next page 1006				

No.	Name	EAN-no.	Type	Description	Manufacture	Ref. position	Remarks
141	-W204		2x1.0mm ²			232/3	*
142	-W205		2x1.0mm ²			82/6	*
143	-W207		2x1.0mm ²			239/0	*
144	-W208		2x1.0mm ²			239/3	*
145	-W209		2x1.0mm ²			240/0	*
146	-W210		2x1.0mm ²			240/3	*
147	-W211		3x1.0mm ²			238/6	*
148	-W212		3x1.0mm ²			238/0	*
149	-W213		2x1.0mm ²			241/0	*
150	-W215		5x1.0mm ²			241/4	*
151	-W217		2x1.0mm ²			240/9	*
152	-W226		Permanent 24VDC(max 1A)			81/4	*
153	-W227		PTC inside motor 2x1.0mm ²			81/5	*
154	-W228		PTC inside motor 2x1.0mm ²			81/7	*
155	-W236		2x1.0mm ²			240/6	*
156	-W500		Shielded ethernet cable			210/3	*
157	-W501		Shielded ethernet cable			210/6	*
158	-W503		3x1.0mm ²			248/6	*
159	-W504		3x1.0mm ²			248/6	*
160	-WX1		2x1.0mm ²			249/1	*
161	-WX2		2x1.0mm ²			249/2	*
162	-WX3		2x1.0mm ²			249/4	*
163	-WX4		2x1.0mm ²			249/6	*
164	-WX5		2x1.0mm ²			249/7	*
165	-X1					510/2	*
166	-X1		UTT 2,5			231/6	*
167	-X1		UTT 2,5-DIO/O-U			240/1	*
168	-X1		UTT 2,5 - 3044636			248/3	*

* Use of components with equivalent electric, mechanical and approval specifications is acceptable

This schematic is AB Ph. Nederman & Co property. The schematic and any adjoining information must not be made accessible to representatives of other companies without our permission

Revision	2	Product	HVCP Std 45kW Insight			COMPONENT LIST	Drawing no.	Page no.
Status	Available			2183626			1006	
Date of approval	-	Date of created	2020-03-25					
Approval by	-	Author	FRALE					
1005	Previous page					Next page	1007	

Pos.	Name	I/O	Description	Signalway	Connected to	Card type
1	-A1:AI0	AI0	(ASC) Current Sensor			6ES7214-1AG31-0XB0
2	-A1:AI1	AI1	Vacuum Sensor input dP FlexFilter 13/18			6ES7214-1AG31-0XB0
3	-A1:DIB.5	I0.5	Main filter DPS Configurable (DFC-08M alarm (when no replica))			6ES7214-1AG40-0XB0
4	-A1:Dla.0	I0.0	Pilot Signal (PS)	-X1:4,-W102:2,-PS,-PS	-PS	6ES7214-1AG31-0XB0
5	-A1:Dla.1	I0.1	Compressed air switch (CAS)	-X1:34,-W110:3	-CAS	6ES7214-1AG31-0XB0
6	-A1:Dla.2	I0.2	Thermal switches (TS)	-X1:36,-W110:6,-TB1:36,-TB1:35-XX2		6ES7214-1AG31-0XB0
7	-A1:Dla.3	I0.3	Motor protector +(PTC (EX))		-F7	6ES7214-1AG31-0XB0
8	-A1:Dla.4	I0.4	Level indicator on dust bin (BLI)	-X1:59,-W116:BN	-BLI (EX)	6ES7214-1AG31-0XB0
9	-A1:Dla.5	I0.5	Main filter DPS Configurable (DFC-08M alarm (when no replica))	-X1:192,-W136:1	-MF-DPS4	6ES7214-1AG31-0XB0
10	-A1:Dla.6	I0.6	Remote St.By/Off/OTTmr	-X1:6,-W103:1	-S3	6ES7214-1AG31-0XB0
11	-A1:Dla.7	I0.7	Emergency stop (EX-Venting panel)		-A21	6ES7214-1AG31-0XB0
12	-A1:Dlb.0	I1.0	Maintenance switch	-X1:2,-W101:2	-MS1	6ES7214-1AG31-0XB0
13	-A1:Dlb.1	I1.1	Closing function in D-mode		-K2	6ES7214-1AG31-0XB0
14	-A1:Dlb.2	I1.2	Level Indicator (LI) (Emptying on demand) Configurable	-X1:46,-W112:Bk/Or	-LI (EX)	6ES7214-1AG31-0XB0
15	-A1:Dlb.3	I1.3	Control filter DPS 1 Configurable	-X1:66,-W117:1	-CF-DPS1	6ES7214-1AG31-0XB0
16	-A1:Dlb.4	I1.4	Manual emptying TVFD/AEB (NS)	-X1:56,-W115:2	-S1	6ES7214-1AG31-0XB0
17	-A1:Dlb.5	I1.5	Fire Alarm		-K9	6ES7214-1AG31-0XB0
18	-A1:DQa.0	Q0.0	NoAlarm (Reset Safety circ.)		-K8	6ES7214-1AG31-0XB0
19	-A1:DQa.1	Q0.1	Alarm message lamp lamp in front panel		-H1	6ES7214-1AG31-0XB0
20	-A1:DQa.2	Q0.2	Warning DPS BLI and LI (relay is energized at warnig active)		-K11	6ES7214-1AG31-0XB0
21	-A1:DQa.3	Q0.3	Filter Cleaning Valve V1 dust collector Configurable FlexF 13/18 v1 (replica)		-K13	6ES7214-1AG31-0XB0
22	-A1:DQa.4	Q0.4	Filter Cleaning Valve V2 dust collector Configurable FlexF 13/18 v1 (replica)		-K14	6ES7214-1AG31-0XB0
23	-A1:DQa.5	Q0.5	Run(Start motor)		-K12	6ES7214-1AG31-0XB0
24	-A1:DQa.6	Q0.6	Solenoid V10 in vacuum unit (Start up valve / Idling (RBU))		-K15	6ES7214-1AG31-0XB0
25	-A1:DQa.7	Q0.7	Upper solenoid V11 TVFD 1 Configurable		-K16	6ES7214-1AG31-0XB0
26	-A1:DQb.0	Q1.0	Lower solenoid V12 TVFD 1 Emptying AEB; Configurable		-K17	6ES7214-1AG31-0XB0
27	-A1:DQb.1	Q1.1	On/standby lamp (external)		-K18	6ES7214-1AG31-0XB0
28	-A1/1:DQe.0	4.00	Config output K19 ASC move/Flush 1		-K19	6ES7222-1BD30-0XB0
29	-A1/1:DQe.1	4.01	Config output K20 ASC open/Flush 2		-K20	6ES7222-1BD30-0XB0

This schematic is AB Ph. Nederman & Co property. The schematic and any adjoining information must not be made accessible to representatives of other companies without our permission

Revision		Product		PLC LIST	Drawing no. 2183626	Page no. 1011
Status	Available	Product				
Date of approval	-	Product				
Approval by	-	Date of created				
1007	previous page	2020-03-25	Author	FRALE		Next page 1012

Pos.	Name	I/O	Description	Signalway	Connected to	Card type
30	-A1/1:DQe.2	4.02	LCC start		-K21	6ES7222-1BD30-0XB0
31	-A1/1:DQe.3	4.03	MUX AI0 Current AI1 Pressure	-K22:A1,-K21:A2,-K21:A1	-A1/1	6ES7222-1BD30-0XB0
32						
33						
34						
35						
36						
37						
38						
39						
40						
41						
42						
43						
44						
45						
46						
47						
48						
49						
50						
51						
52						
53						
54						
55						
56						
57						
58						

This schematic is AB Ph. Nederman & Co property. The schematic and any adjoining information must not be made accessible to representatives of other companies without our permission

Revision	Available	Product		PLC LIST	Drawing no. 2183626	Page no. 1012
Status	-	HVCP Std 45kW Insight				
Date of approval	-	Date of created 2020-03-25				
Approval by	-	Author FRALE				
1011	previous page					Next page 1014

From			Cable		To			Type	Length
Description	Ref. position	Function	Description	Page/lineaway	Description	Ref. position	Function		
-Q1	50/1	Main Switch 125A	-W0	50/1	-MF	50/1	Main fuse	Power Cable	
-F7	80/0	18-90A	-W1	80/0	-MS1	80/0	Maintenance Switch	Motor Cable >= 3x10mm ² + PE	
-K2	80/2	D Contactor	-W2	80/2	-MS1	80/2	Maintenance Switch	Motor Cable >= 3x10mm ² + PE	
-MS1	80/0	Maintenance Switch	-W3	80/0	-M1	80/1	VAC/RBU Motor	Motor Cable >= 3x10mm ² + PE	
-MS1	80/2	Maintenance Switch	-W4	80/2	-M1	80/2	VAC/RBU Motor	Motor Cable >= 3x10mm ² + PE	
-X1	232/1		-W101	232/1	-MS1	232/1	Signal Contact Maintenance switch	2x1.0mm ²	
-X1	230/1		-W102	230/1	-PS	230/1	Pilot Signal	2x1.0mm ²	
-X1	231/8		-W103	231/8	-S3	231/8	Remote St.By/Off/OTTmr=Overtime	2x1.0mm ²	
-X1	70/3		-W104	70/3	-S5	70/3	External E-stop	2x1.0mm ²	
-X1	70/5		-W105	70/5	-AUX-SAFE1	70/5	Auxiliary safety circuit	2x1.0mm ²	
-X1	70/6		-W106	70/6	-AUX-SAFE2	70/6	Auxiliary safety circuit	2x1.0mm ²	
-X1	70/7		-W107	70/7	-AUX-SAFE3	70/7	Auxiliary safety circuit	2x1.0mm ²	
-X1	70/8		-W108	70/8	-AUX-SAFE4	70/8	Auxiliary safety circuit	2x1.0mm ²	
-X1	70/9		-W109	70/9	-AUX-SAFE5	70/9	Auxiliary safety circuit	2x1.0mm ²	
-X1	239/7		-W110	239/7	-TB1	239/7		12x0,75mm ²	
-X1	231/4		-W111	231/4	-MF-DPS2	231/4	Main Filter DPS	2x1.0mm ²	
-X1	232/7		-W112	232/7	-LI (EX)	232/8	Level Indicator (LI)	3x1,0mm ²	
-X1	70/1		-W113	70/1	-FA1	70/1	Fire alarm	2x1.0mm ²	
-X1	231/3		-W114	231/3	- MF-DPS1	231/3	Main Filter DPS.	2x1.0mm ²	
-X1	233/5		-W115	233/5	-S1	233/5	Manual emptying TVFD/AEB (NS)	2x1.0mm ²	
-X1	231/1		-W116	231/1	-BLI (EX)	231/2	Level indicator on dust bin (BLI)	3x1.0mm ²	
-X1	233/0		-W117	233/0	-CF-DPS1	233/1	Control filter DPS (1) - (1-2)	2x1.0mm ²	
-X1	231/5		-W135	231/5	-MF-DPS3	231/5	Main Filter DPS	2x1.0mm ²	
-X1	231/5		-W136	231/5	-MF-DPS4	231/5	Main Filter DPS	2x1.0mm ²	
-X1	70/0		-W137	70/0	-FA2	70/0	Fire alarm	2x1.0mm ²	
-X1	71/6		-W200	71/6	-AUX- E-STOP	71/6	E-Stop signal to external control panel	2x1.0mm ²	
-X1	82/1		-W203	82/1	-AUX1	82/1	E-Stop Controlled 24VDC supply	2x1.0mm ²	
-X1	232/4		-W204	232/4	-AUX2	232/4	Delta contactor active (motor running) Signal to external system	2x1.0mm ²	

This schematic is AB Ph. Nederman & Co property. The schematic and any adjoining information must not be made accessible to representatives of other companies without our permission

Revision	2	Product	HVCP Std 45kW Insight			CABEL OVERVIEW	Drawing no.	Page no.	
Status	Available						CABEL OVERVIEW	2183626	1014
Date of approval	-	Date of created	2020-03-25						
Approval by	-	Author	FRALE						
1012	previous page					Next page 1015			

From			Cable		To			Type	Length
Description	Ref. position	Function	Description	Page/lineway	Description	Ref. position	Function		
-X1	82/6		-W205	82/6	-AUX3	82/6	E-Stop Controlled, 24VAC	2x1.0mm ²	
-X1	239/1		-W207	239/1	-V1	239/1	Filter Cleaning Valve V1	2x1.0mm ²	
-X1	239/3		-W208	239/3	-V2	239/4	Filter Cleaning Valve V2	2x1.0mm ²	
-X1	240/1		-W209	240/1	-V3	240/1	Filter Cleaning Valve V3	2x1.0mm ²	
-X1	240/4		-W210	240/4	-V4	240/4	Filter Cleaning Valve V4	2x1.0mm ²	
-X1	238/6		-W211	238/6	-EXT WARNING	238/6	External Warning Output	3x1.0mm ²	
-X1	238/0		-W212	238/0	-EXT ALARM	238/0	No summary alarm	3x1.0mm ²	
-PE	60/6	PE	-W213	241/1	-V13	241/1	ASC Move	2x1.0mm ²	
-X1	241/5		-W215	241/5				5x1.0mm ²	
-X1	240/6		-W217	240/9	-H2	240/9	On/standby lamp (external)	2x1.0mm ²	
-X1	81/4		-W226	81/4				Permanent 24VDC(max 1A)	
-X1	81/5		-W227	81/5				PTC inside motor 2x1.0mm ²	
-X1	81/8		-W228	81/8				PTC inside motor 2x1.0mm ²	
-X1	240/7		-W236	240/7	-AUX4	240/7	Ready / idle signal	2x1.0mm ²	
-PBC1	210/2	KTP401 Touch panel	-W500	210/2	-PBC1	210/5	PLC S7-1200 input	Shielded ethernet cable	
-X1	248/6	Spare Terminal (20) Not Specified	-W503	248/6	-SP1	248/7	AI:1 Optional: Pressure Transducer	3x1.0mm ²	
-X1	248/6	Spare Terminal (20) Not Specified	-W504	248/6	-SP2	248/7	AI:1 Optional: Pressure Transducer	3x1.0mm ²	
-X1	249/1	Spare Term	-WX1	249/1	-SPARE_TERMINAL	249/1	-SPARE_TERMINAL	2x1.0mm ²	
-X1	249/3	Spare Term	-WX2	249/3	-SPARE_TERMINAL	249/3	-SPARE_TERMINAL	2x1.0mm ²	
-X1	249/4	Spare Term	-WX3	249/4	-SPARE_TERMINAL	249/4	-SPARE_TERMINAL	2x1.0mm ²	
-X1	249/6	Spare Term	-WX4	249/6	-SPARE_TERMINAL	249/6	-SPARE_TERMINAL	2x1.0mm ²	
-X1	249/7	Spare Term	-WX5	249/7	-SPARE_TERMINAL	249/7	-SPARE_TERMINAL	2x1.0mm ²	

This schematic is AB Ph. Nederman & Co property. The schematic and any adjoining information must not be made accessible to representatives of other companies without our permission

Revision	2	Product	HVCP Std 45kW Insight			CABEL OVERVIEW	Drawing no.	Page no.	
Status	Available						CABEL OVERVIEW	2183626	1015
Date of approval	-	Date of created	2020-03-25						
Approval by	-	Author	FRALE						
1014	previous page						Next page	1017	

No.	Connected to (external)		Terminal			Connected to (internal)		Type	Ref. position	Remarks
	Destination	Connection	Name	Number	Jumper	Destination	Connection			
1			-ET1	1		24VDC+		UK 2,5 N	210/7	
2			-ET1	2		24VDC-		UK 2,5 N	210/7	
3			-K22			-A1/1	DQe.3	PLC-RSC- 24DC/21-21AU	241/9	
4			-K22			24VDC-		PLC-RSC- 24DC/21-21AU	241/9	
5	-PE		-PE			0V		WT 4 PE	60/4	
6	-PE		-PE			24VDC-		WT 4 PE	60/6	
7	-CF-DPS1_		-X1	66_					510/2	
8			-X1	67_		24VDC+			510/3	
9	-TERMINAL BOX	1	-X1	141_		24VDC+			510/3	
10	-LI (EX)	- Blue	-X1	40		24VDC-		UTTBT 2,5 - 3044636	232/6	
11	-W226	1	-X1	141		24VDC+		UTTBT 2,5 - 3044636	81/4	
12	-W227	1	-X1	143		24VDC+		UTTBT 2,5 - 3044636	81/5	
13	-W228	1	-X1	145		24VAC		UTTBT 2,5 - 3044636	81/8	
14	-MS1	13	-X1	1		24VDC+		UTTBT 2,5 - 3044636	232/1	
15	-W226	2	-X1	142		24VDC-		UTTBT 2,5 - 3044636	81/4	
16	-W227	2	-X1	144		24VDC-		UTTBT 2,5 - 3044636	81/6	
17	-W228	2	-X1	146		0V		UTTBT 2,5 - 3044636	81/8	
18	-MS1	14	-X1	2		-A1	D1b.0	UTTBT 2,5 - 3044636	232/2	
19	-PS		-X1	3		-F6	2	UTTBT 2,5 - 3044636	230/1	
20	-PS		-X1	4		-A1	D1a.0	UTTBT 2,5 - 3044636	230/2	
21	-X1	6	-X1	5				UTTBT 2,5 - 3044636	231/8	
22	-S3	1	-X1	5		24VDC+		UTTBT 2,5 - 3044636	231/8	
23	-X1	5	-X1	6				UTTBT 2,5 - 3044636	231/9	
24	-S3	2	-X1	6		-A1	D1a.6	UTTBT 2,5 - 3044636	231/9	
25	-SPARE_TERMINAL4	2	-X1	137				UTTBT 2,5 - 3044636	249/6	
26	-SPARE_TERMINAL5	2	-X1	150				UTTBT 2,5 - 3044636	249/8	
27	-AUX- E-STOP	1	-X1	15		-A21	34	UTTBT 2,5 - 3044636	71/6	
28	-SPARE_TERMINAL1	1	-X1	19				UTTBT 2,5 - 3044636	249/1	

This schematic is AB Ph. Nederman & Co property. The schematic and any adjoining information must not be made accessible to representatives of other companies without our permission

Revision	2	Product	HVCP Std 45kW Insight			TERMINAL LIST	Drawing no.	Page no.	
Status	Available						TERMINAL LIST	2183626	1017
Date of approval	-	Date of created	2020-03-25						
Approval by	-	Author	FRALE						
1015	previous page					Next page 1018			

No.	Connected to (external)		Terminal			Connected to (internal)		Type	Ref. position	Remarks
	Destination	Connection	Name	Number	Jumper	Destination	Connection			
29	-SPARE_TERMINAL2	1	-X1	39				UTTBT 2,5 - 3044636	249/3	
30	-SPARE_TERMINAL3	1	-X1	84				UTTBT 2,5 - 3044636	249/4	
31	-SPARE_TERMINAL4	1	-X1	99				UTTBT 2,5 - 3044636	249/6	
32	-SPARE_TERMINAL5	1	-X1	149				UTTBT 2,5 - 3044636	249/7	
33	-AUX- E-STOP	2	-X1	16		-A21	33	UTTBT 2,5 - 3044636	71/6	
34	-SPARE_TERMINAL1	2	-X1	20				UTTBT 2,5 - 3044636	249/1	
35	-SPARE_TERMINAL2	2	-X1	68				UTTBT 2,5 - 3044636	249/3	
36			-X1	136		-R1	2	UTTBT 2,5 - 3044636	248/3	
37	-AUX1	2	-X1	26	a	24VDC-		UTTBT 2,5 - 3044636	82/2	
38	-AUX1	1	-X1	25		24VDC+(E)		UTTBT 2,5 - 3044636	82/1	
39	-AUX3	1	-X1	29		24VAC(E)		UTTBT 2,5 - 3044636	82/6	
40	-AUX3	2	-X1	30		0V		UTTBT 2,5 - 3044636	82/6	
41	-TB1	32	-X1	32		24VDC-		UTTBT 2,5 - 3044636	239/8	
42	-TB1	31	-X1	31		-K15	14	UTTBT 2,5 - 3044636	239/7	
43	-X1	34	-X1	33				UTTBT 2,5 - 3044636	230/4	
44	-CAS		-X1	33		24VDC+		UTTBT 2,5 - 3044636	230/4	
45	-X1	33	-X1	34				UTTBT 2,5 - 3044636	230/5	
46	-CAS		-X1	34		-A1	D1a.1	UTTBT 2,5 - 3044636	230/5	
47	-TB1	35	-X1	35		24VDC+		UTTBT 2,5 - 3044636	230/6	
48	-TB1	36	-X1	36		-A1	D1a.2	UTTBT 2,5 - 3044636	230/7	
49	-V1	2	-X1	42		24VDC-		UTTBT 2,5-DIO/O-U	239/1	
50			-X1	41		-K13	14	UTTBT 2,5-DIO/O-U	239/1	
51	-V1	1	-X1	41		-D1	2	UTTBT 2,5-DIO/O-U	239/1	
52	-V2	2	-X1	44		24VDC-		UTTBT 2,5-DIO/O-U	239/3	
53			-X1	43		-K14	14	UTTBT 2,5-DIO/O-U	239/4	
54	-V2	1	-X1	43		-D2	2	UTTBT 2,5-DIO/O-U	239/4	
55	-LI (EX)	+ Brown	-X1	45		24VDC+		UTTBT 2,5 - 3044636	232/7	
56	-LI (EX)	Bk/Rd	-X1	46		-A1	D1b.2	UTTBT 2,5 - 3044636	232/8	

This schematic is AB Ph. Nederman & Co property. The schematic and any adjoining information must not be made accessible to representatives of other companies without our permission

Revision	2	Product	HVCP Std 45kW Insight			TERMINAL LIST	Drawing no.	Page no.
Status	Available			2183626			1018	
Date of approval	-	Date of created	2020-03-25					
Approval by	-	Author	FRALE					Next page
1017	previous page							

No.	Connected to (external)		Terminal			Connected to (internal)		Type	Ref. position	Remarks
	Destination	Connection	Name	Number	Jumper	Destination	Connection			
57	- MF-DPS1		-X1	49		24VDC+		UTTBT 2,5 - 3044636	231/3	
58	- MF-DPS1		-X1	50		-X1	187	UTTBT 2,5 - 3044636	231/4	
59	-S1		-X1	55		24VDC+		UTTBT 2,5 - 3044636	233/5	
60	-S1		-X1	56		-A1	D1b.4	UTTBT 2,5 - 3044636	233/6	
61	-BLI (EX)	Black	-X1	57				UTTBT 2,5 - 3044636	231/1	
62	-BLI (EX)	+ Brown	-X1	57				UTTBT 2,5 - 3044636	231/1	
63	-X1	59	-X1	57		24VDC+		UTTBT 2,5 - 3044636	231/1	
64	-BLI (EX)	Bk/Rd	-X1	59				UTTBT 2,5 - 3044636	231/1	
65	-X1	57	-X1	59		-A1	D1a.4	UTTBT 2,5 - 3044636	231/1	
66	-BLI (EX)	- Blue	-X1	58		24VDC-		UTTBT 2,5 - 3044636	231/1	
67	-EXT WARNING	1	-X1	60		-K11	11	UTTBT 2,5 - 3044636	238/6	
68	-EXT WARNING	2	-X1	61		-K11	14	UTTBT 2,5 - 3044636	238/6	
69	-EXT WARNING	3	-X1	62		-K11	12	UTTBT 2,5 - 3044636	238/7	
70	-EXT ALARM	1	-X1	63		-K10	11	UTTBT 2,5 - 3044636	238/0	
71	-AUX2	1	-X1	17		-K2	84	UTTBT 2,5 - 3044636	232/4	
72	-AUX2	2	-X1	18		-K2	83	UTTBT 2,5 - 3044636	232/4	
73	-SV1	Signal	-X1	138	a	-K22	14	UTTBT 2,5 - 3044636	248/3	
74	-X1	188	-X1	187				UTTBT 2,5	231/4	
75	-MF-DPS2		-X1	187		-X1	50	UTTBT 2,5	231/4	
76	-X1	187	-X1	188				UTTBT 2,5	231/4	
77	-MF-DPS2		-X1	188		-X1	189	UTTBT 2,5	231/4	
78	-X1	190	-X1	189				UTTBT 2,5	231/5	
79	-MF-DPS3		-X1	189		-X1	188	UTTBT 2,5	231/5	
80	-X1	189	-X1	190				UTTBT 2,5	231/5	
81	-MF-DPS3		-X1	190		-X1	191	UTTBT 2,5	231/5	
82	-X1	192	-X1	191				UTTBT 2,5	231/5	
83	-MF-DPS4		-X1	191		-X1	190	UTTBT 2,5	231/5	
84	-X1	191	-X1	192				UTTBT 2,5	231/6	

This schematic is AB Ph. Nederman & Co property. The schematic and any adjoining information must not be made accessible to representatives of other companies without our permission

Revision	2	Product	HVCP Std 45kW Insight			TERMINAL LIST	Drawing no.	Page no.
Status	Available			2183626			1019	
Date of approval	-	Date of created	2020-03-25					
Approval by	-	Author	FRALE					Next page
1018	previous page							

No.	Connected to (external)		Terminal			Connected to (internal)		Type	Ref. position	Remarks
	Destination	Connection	Name	Number	Jumper	Destination	Connection			
85	-MF-DPS4		-X1	192		-A1	Dla.5	UTTBT 2,5	231/6	
86	-EXT ALARM	2	-X1	64		-K10	14	UTTBT 2,5 - 3044636	238/1	
87	-EXT ALARM	3	-X1	65		-K10	12	UTTBT 2,5 - 3044636	238/1	
88	-CF-DPS1		-X1	67		24VDC+		UTTBT 2,5 - 3044636	233/1	
89	-CF-DPS1		-X1	66		-A1	Dlb.3	UTTBT 2,5 - 3044636	233/0	
90	-X1	72	-X1	71				UTTBT 2,5 - 3044636	241/0	
91	-W213	1	-X1	71		24VAC(E)		UTTBT 2,5 - 3044636	241/0	
92	-X1	71	-X1	72		-K19	11	UTTBT 2,5 - 3044636	241/1	
93	-X1	75	-X1	73				UTTBT 2,5 - 3044636	241/1	
94	-V13	1	-X1	73		-K19	14	UTTBT 2,5 - 3044636	241/1	
95	-W213	4	-X1	74		-K19	12	UTTBT 2,5 - 3044636	241/1	
96	-W110	10	-X1	75				UTTBT 2,5 - 3044636	241/3	
97	-X1	73	-X1	75		-K20	11	UTTBT 2,5 - 3044636	241/3	
98	-MV1	76	-X1	76		0V		UTTBT 2,5 - 3044636	241/3	
99	-MV1	77	-X1	77		-K20	14	UTTBT 2,5 - 3044636	241/3	
100	-MV1	78	-X1	78		-K20	12	UTTBT 2,5 - 3044636	241/3	
101	-W215	1	-X1	79		24VDC+(E)		UTTBT 2,5 - 3044636	241/5	
102	-W215	3	-X1	81		-K21	11	UTTBT 2,5 - 3044636	241/5	
103	-W215	4	-X1	82		-K21	14	UTTBT 2,5 - 3044636	241/6	
104	-W215	5	-X1	83		-K21	12	UTTBT 2,5 - 3044636	241/6	
105	-W215	2	-X1	80		24VDC-		UTTBT 2,5 - 3044636	241/5	
106			-X1	87		24VDC+(E)		UTTBT 2,5 - 3044636	240/6	
107	-H2	X2	-X1	88	b	24VDC-		UTTBT 2,5 - 3044636	240/6	
108	-SP1	0V	-X1	196		24VDC-		UTTBT 2,5 - 3044636	248/7	
109	-SP1	+24V	-X1	195				UTTBT 2,5 - 3044636	248/8	
110	-SP2	+24V	-X1	195		24VDC+		UTTBT 2,5 - 3044636	248/8	
111	-SV1	DO(NC)	-X1	135				UTTBT 2,5 - 3044636	248/3	
112	-SV1	24VDC-	-X1	134		24VDC-		UTTBT 2,5 - 3044636	248/2	

This schematic is AB Ph. Nederman & Co property. The schematic and any adjoining information must not be made accessible to representatives of other companies without our permission

Revision	2	Product	HVCP Std 45kW Insight			TERMINAL LIST	Drawing no.	Page no.
Status	Available			2183626			1020	
Date of approval	-	Date of created	2020-03-25					
Approval by	-	Author	FRALE					Next page
1019	previous page							

No.	Connected to (external)		Terminal			Connected to (internal)		Type	Ref. position	Remarks
	Destination	Connection	Name	Number	Jumper	Destination	Connection			
113	-SV1	24VDC+	-X1	133		24VDC+		UTTBT 2,5 - 3044636	248/2	
114	-SP2	Sign	-X1	185		-K22	24	UTTBT 2,5 - 3044636	248/6	
115	-SP1	Sign	-X1	186		-K22	22	UTTBT 2,5 - 3044636	248/6	
116	-SP2	0V	-X1	198		24VDC-		UTTBT 2,5 - 3044636	248/7	
117	-H2	X1	-X1	90				UTTBT 2,5 - 3044636	240/7	
118	-AUX4	2	-X1	90		-K18	11	UTTBT 2,5 - 3044636	240/7	
119	-AUX4	1	-X1	89	b	-K18	14	UTTBT 2,5 - 3044636	240/7	
120	-V3	2	-X1	52		24VDC-		UTTBT 2,5-DIO/O-U	240/1	
121			-X1	51		-D3	2	UTTBT 2,5-DIO/O-U	240/1	
122	-V3	1	-X1	51		-K16	14	UTTBT 2,5-DIO/O-U	240/1	
123	-V4	2	-X1	54		24VDC-		UTTBT 2,5 - 3044636	240/5	
124			-X1	53		-D4	2	UTTBT 2,5 - 3044636	240/4	
125	-V4	1	-X1	53		-K17/1	14	UTTBT 2,5 - 3044636	240/4	
126	-X1	7	-X1	8				UTTBT 2,5 - 3044636	70/3	
127		12	-X1	8		-X1	9	UTTBT 2,5 - 3044636	70/3	
128	-X1	10	-X1	9				UTTBT 2,5 - 3044636	70/5	
129	-AUX-SAFE1	1	-X1	9		-X1	8	UTTBT 2,5 - 3044636	70/5	
130	-AUX-SAFE1	2	-X1	10				UTTBT 2,5 - 3044636	70/5	
131	-X1	9	-X1	10				UTTBT 2,5 - 3044636	70/5	
132	-X1	12	-X1	11				UTTBT 2,5 - 3044636	70/6	
133	-AUX-SAFE2	1	-X1	11				UTTBT 2,5 - 3044636	70/6	
134	-X1	22	-X1	21				UTTBT 2,5 - 3044636	70/8	
135	-AUX-SAFE4	1	-X1	21				UTTBT 2,5 - 3044636	70/8	
136	-AUX-SAFE2	2	-X1	12				UTTBT 2,5 - 3044636	70/6	
137	-X1	11	-X1	12				UTTBT 2,5 - 3044636	70/6	
138	-AUX-SAFE4	2	-X1	22				UTTBT 2,5 - 3044636	70/8	
139	-X1	21	-X1	22				UTTBT 2,5 - 3044636	70/8	
140	-X1	14	-X1	13				UTTBT 2,5 - 3044636	70/7	

This schematic is AB Ph. Nederman & Co property. The schematic and any adjoining information must not be made accessible to representatives of other companies without our permission

Revision	2	Product	HVCP Std 45kW Insight			TERMINAL LIST	Drawing no.	Page no.	
Status	Available						TERMINAL LIST	2183626	1021
Date of approval	-	Date of created	2020-03-25						
Approval by	-	Author	FRALE						
1020	previous page					Next page 1022			

