

Control Panels/Starters

HV Control Panel EX Insight



Original installation and service manual

EN INSTALLATION AND SERVICE MANUAL

Table of contents

Figures	5
1 Preface	8
2 Safety	8
2.1 Classification of important information	8
2.2 General safety instructions	8
3 Description	9
3.1 Intended use and function	9
3.1.1 Insight ready	9
3.2 Main parts	10
3.3 Technical specifications	10
3.3.1 Cabinet dimensions	10
3.3.2 Technical data	11
4 Installation	13
4.1 Delivery check	13
4.2 Mounting	13
4.3 Verify the signal strength	13
4.4 Electrical installation	14
4.4.1 Gather system information	14
4.4.2 Power cable W0 installation into Q1	15
4.4.3 Motor cable W1 installation into F7	15
4.4.4 Motor cable W2 installation into K2	15
4.4.5 Installation of maintenance switch (MS)	15
4.4.6 Installation motor cables W3 and W4	16
4.4.7 Supplementary equipotential	16
4.4.8 T1 Control transformer voltage settings	16
4.4.9 Motor overload protector (F7) settings	17
4.4.10 Y/D Timer relay setting (K4T)	18
4.4.11 PTC Sensor	18
4.4.12 Installation of control signals	18
4.4.13 To do before powering up the control panel	19
4.4.14 Power up of control panel	19
4.4.15 Electrical installation tables	20
4.5 Connect FlexFilter	21
5 Control panel	22
5.1 Work procedure for installation	22
5.2 Control panel overview	22
5.2.1 Display/Screen navigation	23
5.3 HOME screen	23
5.3.1 101 - HOME	23
5.3.2 102 - HOME 2	25
5.4 301 - Settings	25
5.4.1 341 - Logon	26
5.4.2 SSR DIR Service timers	26
5.4.3 330 - Settings Filter Cleaning	27
5.4.4 331 - Settings - Emptying AEB	29
5.4.5 332 - Settings - Emptying TVFD	30
5.4.6 333 - Settings - Emptying Pre-Separator	31
5.4.7 334 -Settings - Emptying rotary valve	32
5.4.8 335 - Settings - Flushing	33
5.4.9 311 - 312 - 313 - 314 - Settings - Weektimer	34
5.5 351 - 352 - 353 - Alarm Delay	36
5.6 336 - 337 - ASC and LCC (only VAC)	38
5.7 321 - System settings	40
5.7.1 HMI restart	40

5.7.2	323 - Set Time	40
5.7.3	322 - Factory reset	41
5.7.4	401 - 403 - PLC I/O Status	41
5.7.5	361 - 362 - 363 - Analog Scaling	42
5.8	380 - System setup: MACRO	44
5.9	Configuration of analogue inputs	46
5.10	701 - Commissioning report	46
6	Remote emptying	47
7	On/StandBy/Start	47
8	Stop/Off	47
9	Remote Standby/Off/Overtime	48
10	FlexFilter 13/18 with DFC-08M	48
11	Alarms	48
11.1	Alarm and Warning relays and lamp	48
11.2	Lists of possible alarms and warnings	49
12	Troubleshooting	52
13	Maintenance	52
13.1	Routine inspection and service	52
13.2	Cleaning	52
14	Spare parts	53
14.1	Ordering spare parts	53
15	Recycling	53
16	Acronyms	54
17	Appendix A: Installation protocol	55
18	Appendix B: Service protocol	56
19	Appendix C	57

Figures

1

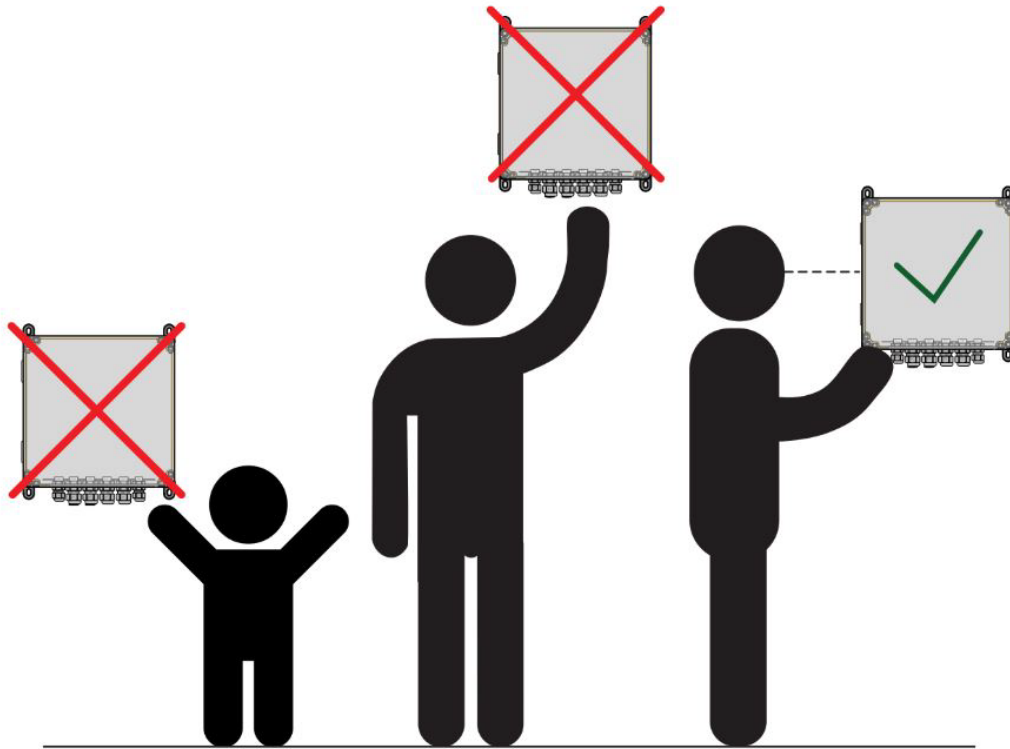

2

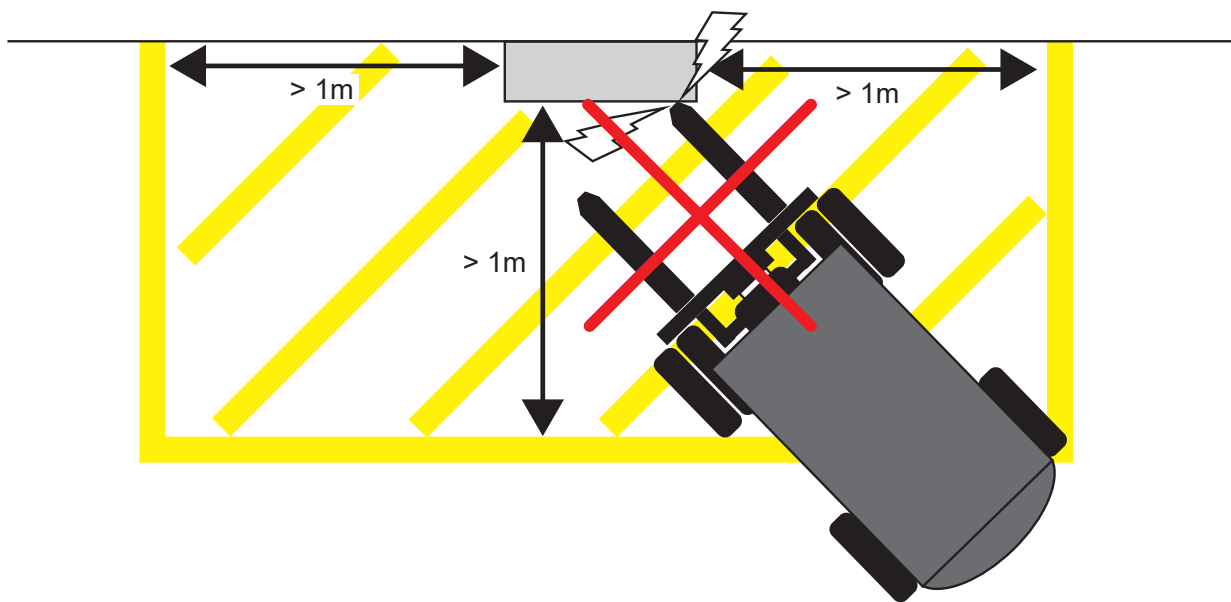

3

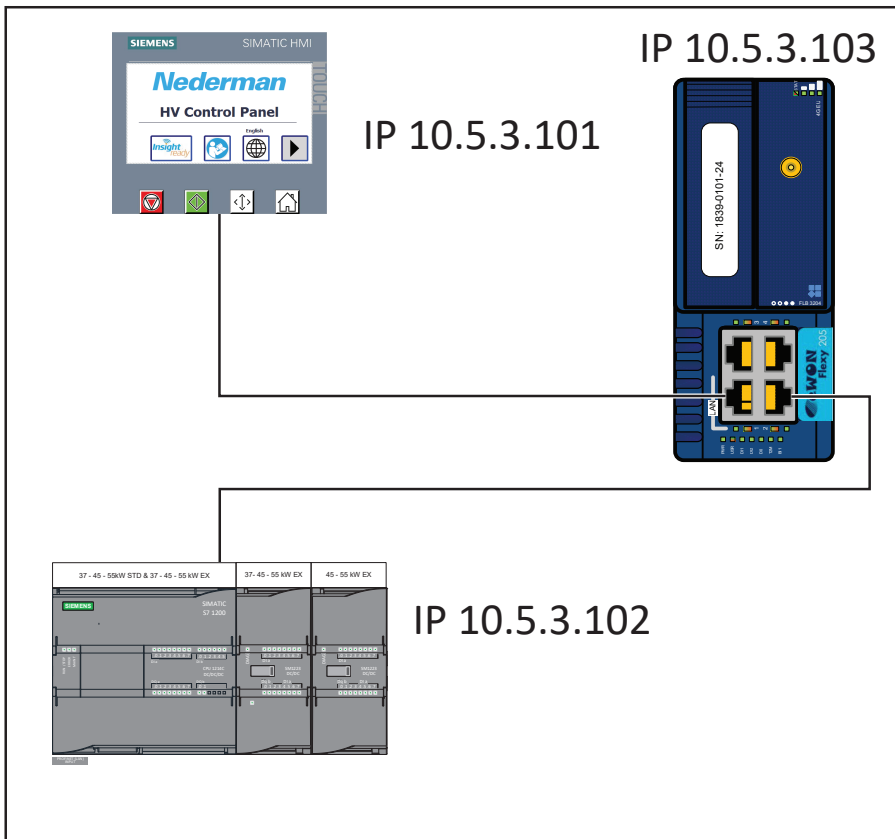
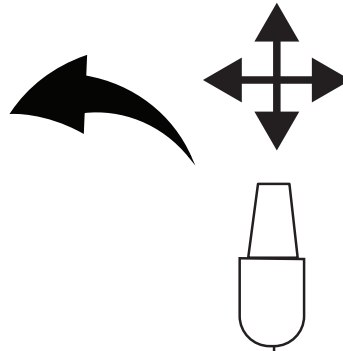

Max. 4,5 m

Shown IP addresses are the factory default settings.

4

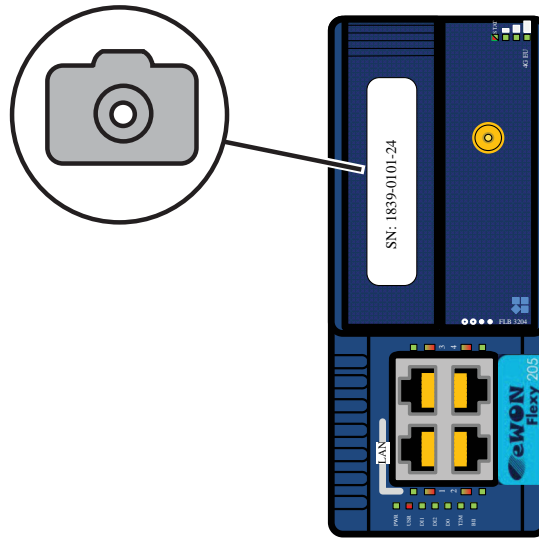

Take a picture of the label pasted on the gateway or write down the content and send it to insight-setup@nederman.com. For more information, see [Chapter 19 Appendix C](#).

5

Tricolour:			
Reception Signal level			
Reception Signal level			
Reception Signal level			

Power	PWR		= ON
User	USR		= OK
Digital IN 1	DI1		Input signal additional equipment
Digital IN 2	DI2		Input signal additional equipment
Digital output	DO		External control signal
Talk2M	T2M		
Button BI1 input	BI1		Not used

1 Preface

Thank you for using a Nederman product!

The Nederman Group is a world-leading supplier and developer of products and solutions for the environmental technology sector. Our innovative products will filter, clean and recycle in the most demanding of environments. Nederman's products and solutions will help you improve your productivity, reduce costs and also reduce the impact on the environment from industrial processes.

Read all product documentation and the product identification plate carefully before installation, use, and service of this product. Replace documentation immediately if lost. Nederman reserves the right, without previous notice, to modify and improve its products including documentation.

This product is designed to meet the requirements of relevant EC directives. To maintain this status, all installation, maintenance, and repair is to be done by qualified personnel using only Nederman original spare parts and accessories. Contact the nearest authorized distributor or Nederman for advice on technical service and obtaining spare parts. If there are any damaged or missing parts when the product is delivered, notify the carrier and the local Nederman representative immediately.

2 Safety

2.1 Classification of important information

This document contains important information that is presented either as a warning, caution or note, according to the following examples:

 **WARNING! Risk of personal injury**
Warnings indicate a potential hazard to the health and safety of personnel, and how that hazard may be avoided.

 **CAUTION! Risk of equipment damage**
Cautions indicate a potential hazard to the product but not to personnel, and how that hazard may be avoided.

 Notes contain other information that is important for personnel.

2.2 General safety instructions

 **WARNING! Risk of explosion**
Do not install the High Vacuum Control Panel EX in an explosive environment. It is only designed to control components/machines that are located in an explosive environment.

 **WARNING! Risk of fire**

- Do not use aluminium cables. Do not connect aluminium cables into the cabinet or terminal box on the VAC/RBU motor.
- If aluminium cables need to be used, use connection boxes with special aluminium/copper transitions for the aluminium cable.
- Make sure cable connections are secure.

 **WARNING! Risk of personal injury**

- Only properly trained personnel are allowed to install, use and service this product.
- Work with electric equipment is to be carried out by a qualified electrician.
- Follow all local rules and regulations for installation, service, and troubleshooting of this product.
- If there is an emergency stop or if the system loses power, any connected pneumatic solenoid valve can unexpectedly cause a part of the system, for example, a valve, to move.
- This equipment is designed to be a part of a complete system installation. The designer of the system as a whole, must guarantee the correct function of all interacting products or components and ensure that the complete system meets all necessary safety requirements.
- Supplementary equipotential bonding may be required according to local regulations.
- Turn off all power to the product before any maintenance and service.

 **CAUTION! Risk of equipment damage**

- Do not install the product close to heat sources.
- This product is not intended for outdoor installation.
- If the transformer supply voltage cable is connected to the wrong voltage input, the HV Control Panel EX Insight will be damaged. By default, the supply voltage to the transformer is connected to 400V voltage input.
- Use only Nederman original spare parts and accessories.

- If there is an emergency stop, do not restart the product until the problem that caused the alarm is corrected and the alarm reset. If the emergency stop button was used, it needs to be reset before the alarm can be reset. See [Section 11.1 Alarm and Warning relays and lamp](#).
- If there is a loss of power, the product needs to be restarted either by pressing the start button, via remote or by the Weektimer. The Weektimer can either be set to start or not start automatically at a power-on during an active period.

Explanation of sign and sticker symbols used on the product components or with documentation.

Sign	Description
	Risk of electric shock. Even when the main switch is turned off to the product, there is still electricity in the cabinet. There may also be control signals with an external supply.

3 Description

3.1 Intended use and function

This HV Control Panel EX Insight is available in three sizes; 37 kW, 45 kW, and 55 kW. It is intended for the control and supervision of a high vacuum system with a Nederman FlexFilter and a vacuum unit (VAC) or a root blower unit (RBU) vacuum source.

- For FlexFilter EX, use the HV Control Panel EX.

The function of the HV Control Panel EX Insight is to control cleaning, and if applicable, emptying of the Nederman FlexFilter and preseparators. It has three control modes: Off, Standby, and Running and it is

equipped with a Weektimer and an overtime function. A pilot signal (PS) is used in installations with automatic start/stop controlled by micro switches on work sites (AS-set).

After power is turned on to the system, the control panel is normally in Off mode. It can be set to Standby mode either by pressing the green Start button or by using the Weektimer. When in Standby mode it waits for a pilot signal to become active.

When the pilot signal is active, the control panel goes into Running mode and starts a VAC or RBU using the Star/Delta (Y/D) method to reduce the starting motor current. During the start sequence, the startup valve in the vacuum unit reduces the motor load and the system goes into Delta (D) mode - in this mode, the valve is activated and the VAC or RBU can supply the system. A test start can be performed by pressing the Test start button.

When the pilot signal becomes deactivated, the start stop relay (SSR) begins to count down. The control panel goes into Standby mode and the VAC/RBU stops. If RBU is selected, the delay idling delay (DIR) also starts to count down, the startup valve opens and the RBU goes into Idling mode.

To reduce the risk of dust accumulation in the duct system, flush valves can be installed in the upstream end of ducts. The flushing function opens these valves in a sequence.

3.1.1 Insight ready

The HV Control Panel EX Insight is prepared for communication with Nederman Insight. A digital subscription service that makes it possible to get feedback on the High Vac filter system status and prevent malfunctions. The feedback can help to optimize the system and unlock potential energy savings. The subscription service also reminds when it is time for service and/or maintenance of the system.

The gateway in the control panel collects data from the control units and sends it to Nederman Insight.

3.2 Main parts

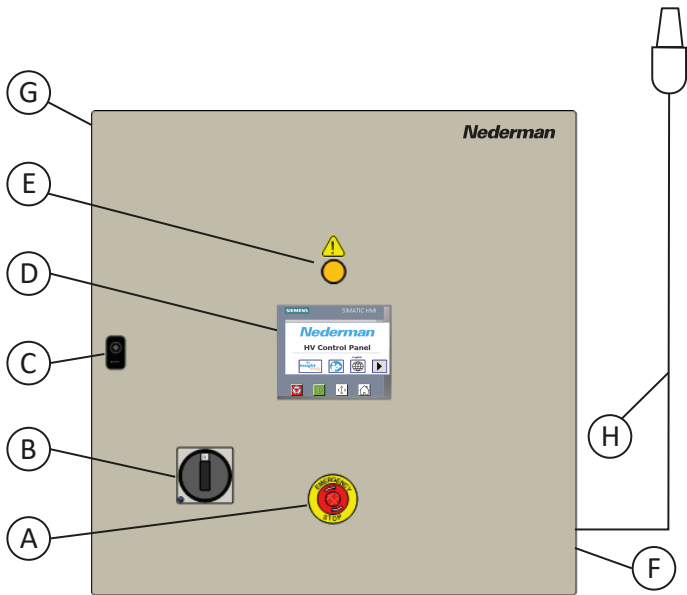

- A Emergency stop button. Used to stop the system in case there is an emergency.
- B Main switch. Turn on power to the control panel.
- C Lock
- D Control panel display
- E Warning lamp
- F Nameplate. This is needed for service and identification.
- G Serial number label, upper left inside the cabinet.
- H Antenna (insight versions)

3.3 Technical specifications

3.3.1 Cabinet dimensions

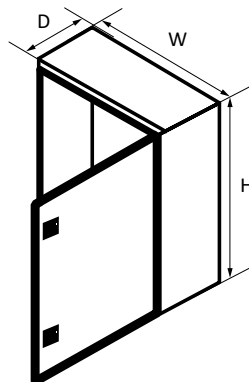

Variant	Width (W) [mm]	Height (H) [mm]	Depth (D) [mm]	Volume [m ³]	Weight [kg]
37 kW	800	800	300	0,192	59
45 kW	800	800	300	0,192	63
55 kW	800	800	300	0,192	64

3.3.2 Technical data

HV Control Panel EX Insight 37 kW

Item	Description
Short Circuit Current Ratings	25 kA
Control Voltage	24 VAC, 6 A / 24 VDC, 5 A
Max installation ambient temperature	Min 0°C (32°F) - Max 40°C (104°F). Indoor use only.
Protection category	IP 65

Motor size [kW]	Supply Voltage [V]	Approx Motor Current [A] [I _{nominal}]	Fre- quency [Hz]	Recommended Main Fuse [A]	Motor Overload setting [A]
18,5-22	230	56-66	50/60	80	0,58 × I _{nominal}
18,5-37	380	34-70	50/60	50-100	0,58 × I _{nominal}
18,5-37	400	32-64	50	50-100	0,58 × I _{nominal}
18,5-37	460	28-56	60	40-80	0,58 × I _{nominal}

HV Control Panel EX Insight 45 kW

Item	Description
Short Circuit Current Ratings	30 kA
Control Voltage	24 VAC, 14 A / 24 VDC, 5 A
Max installation ambient temperature	Min 0°C (32°F) - Max 40°C (104°F). Indoor use only.
Protection category	IP 65

Motor size [kW]	Supply Voltage [V]	Approx Motor Current [A] [I _{nominal}]	Fre- quency [Hz]	Recommended Main Fuse [A]	Motor Overload setting [A]
30	230	90	50/60	100	0,58 × I _{nominal}
30-45	380	55-82	50/60	80-100	0,58 × I _{nominal}
30-45	400	52-78	50	63-100	0,58 × I _{nominal}
30-45	460	45-68	60	63-90	0,58 × I _{nominal}

HV Control Panel EX Insight 55 kW

Item	Description
Short Circuit Current Ratings	30 kA
Control Voltage	24 VAC, 14 A / 24 VDC, 5 A
Max installation ambient temperature	Min 0°C (32°F) - Max 40°C (104°F). Indoor use only.
Protection category	IP 65

Motor size [kW]	Supply Voltage [V]	Approx Motor Current [A] [I _{nominal}]	Fre- quency [Hz]	Recommended Main Fuse [A]	Motor Overload setting [A]
30	230	90	50/60	100	0,58 × I _{nominal}
45-55	380	82-100	50/60	100-125	0,58 × I _{nominal}
45-55	400	78-95	50	100-160	0,58 × I _{nominal}
45-55	460	68-83	60	90-125	0,58 × I _{nominal}

4 Installation



WARNING! Risk of personal injury

Always read [Chapter 2 Safety](#) before installation, use, service, or troubleshooting of this product.

4.1 Delivery check

If there are any damaged or missing parts when the product is delivered, notify the carrier and the local Nederman representative immediately.

4.2 Mounting



Mount the cabinet at an appropriate height and in an easily accessible location. This includes being able to easily access any labels on the product. See [Figure 1](#).

Follow the steps below to mount the product:

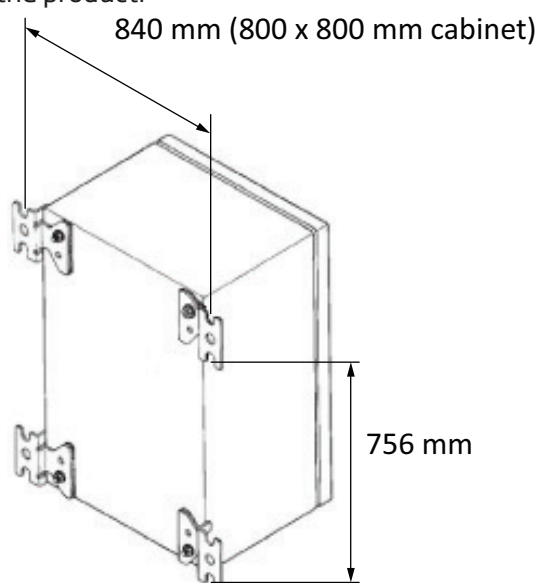

- 1 Install the gland plate to the bottom of the cabinet.
- 2 Attach the wall mounting kit to the rear mounting plate of the cabinet.
- 3 Mount the cabinet to a wall that is strong enough to support the product. Use appropriate bolts and plugs for the surface. The bolts must each stand stress of at least 1500 N. Holes for screws, max \varnothing 10 mm. See also included assembly instructions.

4.3 Verify the signal strength

See [Figure 3](#).

- 1 Use a regular cell phone and locate it in the place where you intend to place the cabinet or the place where you intend to place the antenna.
- 2 If the signal strength is weak, move the phone around and see if you can find better signal strength in the area that the antenna cable reaches. The antenna cable is approximately 4,5 m long, measured from the outside of the cabinet.

4.4 Electrical installation



- Attach cables to the product only through the gland plate on the bottom of the cabinet.
- All electrical wires must have end caps.
- External emergency stop buttons can also be installed if necessary.
- There is also an output for connecting an external alarm lamp.

At delivery, look at the nameplate located on the lower right side of the cabinet, and verify that the correct electrical drawings have been provided with the control panel.

Dimension the power cable and motor cables according to standard rules, taking into account the cable type and distance to the power supply including the distance between the control panel and the VAC/RBU motor.

Only connect copper cables to the control panel and electrical terminals such as the connection box on the VAC/RBU motor.

4.4.1 Gather system information

Fill in the following information:

- Write down the control panel serial number.

Control panel serial number	Notes

- Write down the electrical data of the mains power supply.

Input mains	Mains fuse size and class
Volt	Ampere

- Write down the electrical data of the control panel.

Input power supply	Control transformer (T1) (400 V default)
Volt	Volt

- Write down the VAC/RBU electrical motor data.

Nominal voltage	Rated load current
Volt	Ampere

- Write down the router serial information.

Serial number

4.4.2 Power cable W0 installation into Q1

- 1 Remove the cover plate on the underside of the cabinet: Save the screws and sealing.
- 2 Mount the sealing from the cover plate and place the cabinet flange with the big cable transitions to the left. Use the saved screws from the cover plate to tighten the flange.
- 3 Pull an appropriately sized and approved cable through one of the flange's left cable seals, use the inner left hole.
- 4 Remove the protective covers located on the terminals of the main switch.
- 5 Peel the wires according to the Cable and peeling dimensions table and mount end caps. See [Section 4.4.15 Electrical installation tables](#).
- 6 Place the wires into Q1 according to the Electrical wiring diagram and tighten the screw according to the Tightening Torque for Earth Bus Bar Clamp table. See [Section 4.4.15 Electrical installation tables](#).
- 7 Replace the protective cover on the main switch.
- 8 Tighten the PE wires into the PE bus bar clamp according to the Tightening Torque for Earth Bus Bar Clamp table. See [Section 4.4.15 Electrical installation tables](#).
- 9 Label the power cable in both ends with sign W0.

4.4.3 Motor cable W1 installation into F7

- 1 Pull an appropriately sized and approved cable through one of the flange's left cable seals, use the outer left hole.
- 2 Peel the wires according to the Cable and peeling dimensions table and mount end caps. See [Section 4.4.15 Electrical installation tables](#).
- 3 Tighten the wires into Motor protector F7 according to the Electrical wiring diagram and tighten the screw according to the Tightening Torque for Earth Bus Bar Clamp table. See [Section 4.4.15 Electrical installation tables](#).
- 4 Tighten the PE wires into the PE bus bar clamp according to the Tightening Torque for Earth Bus Bar Clamp table. See [Section 4.4.15 Electrical installation tables](#).
- 5 Label the motor cable in both ends with sign W1.

4.4.4 Motor cable W2 installation into K2

- 1 Pull an appropriately sized and approved cable through one of the flange's left cable seals, use the outer right hole.
- 2 Peel the wires according to the Cable and peeling dimensions table and mount end caps. See [Section 4.4.15 Electrical installation tables](#).
- 3 Tighten the wires into Contactor K2 according to the Electrical wiring diagram and tighten the screw according to the Tightening Torque for Earth Bus Bar Clamp table. See [Section 4.4.15 Electrical installation tables](#).
- 4 Tighten the PE wires into the PE bus bar clamp according to the Tightening Torque for Earth Bus Bar Clamp table. See [Section 4.4.15 Electrical installation tables](#).
- 5 Label the motor cable in both ends with sign W2.

4.4.5 Installation of maintenance switch (MS)

If the control panel is not in the same location or visible according to local regulation, a maintenance switch needs to be installed next to the VAC/RBU.

- 1 Connect the cables according to the Electrical wiring diagram.
- 2 Place and mount the MS close to the VAC/RBU unit.
- 3 Connect the motor cable W1 to terminal 1, 3, and 5.
- 4 Connect the motor cable W3 to terminal 2, 4, and 6. Label the cable in both ends with sign W3.
- 5 Connect the motor cable W2 to terminal 7, 9, and 11.
- 6 Connect the motor cable W4 to terminal 8, 10, and 12. Label the cable in both ends with sign W4.
- 7 Tighten the PE wires from W1 and W3 together into the PE terminal.
- 8 Tighten the PE wires from W2 and W4 together into the PE terminal.
- 9 Connect the MS signal cable contacts 13 and 14 to terminal X1:1 and terminal X1:2 in the control panel. Label the signal cable in both ends with sign W101.
- 10 Pull the cable W126 into the VAC/RBU cabinet and pull it into the motor connection box.
- 11 Connect the PTC sensor wires to cable W126 wires S1 and S2.

12 Label the PTC sensor cable in both ends with sign W126.

4.4.6 Installation motor cables W3 and W4

- 1 Connect the cables according to the Electrical wiring diagram.
- 2 Open the motor connection box and identify the terminal bolt size.
- 3 Pull the cable W3 into the VAC/RBU cabinet and pull it into the motor connection box.
- 4 Peel the wires and mount ring cable shoes on them.
- 5 Tighten the wires onto V1, U1, and W1 in the motor terminal.
- 6 Pull the cable W4 into the VAC/RBU cabinet and pull it into the motor connection box.
- 7 Tighten the wires onto U2, V2, and W2 in the motor terminal.
- 8 Tighten the PE wires from W3 and W4 together into the PE terminal.

4.4.7 Supplementary equipotential

If supplementary potential bonding is required according to local regulations, connect it to the PE on the bus bar.

4.4.8 T1 Control transformer voltage settings

The transformer supply voltage cable is marked with (003). If the power supply is in another voltage, for example, 230 or 460 Volt, the transformer supply voltage cable must be moved to the input that applies to the new power supply voltage.

 All electrical wires must have end caps.

When changing to another power supply voltage, check the T1 primary protection auto fuse F2 setting table and adjust the auto fuse F2 parameter to the new current setting. See [Section 4.4.15 Electrical installation tables](#).

- Fill in the table below after the configuration of transformer T1.

T1 Transformer primary input setting and fuse F2 setting

Alternative setting default (x)	Parameter	Customer setting
230/(400)/460	Supply voltage cable (003)	Volt
-20 V, (0 V), +20 V	Supply voltage cable (004)	Volt
1 - 1,6 A	Primary auto fuse F2 setting	Ampere

4.4.9 Motor overload protector (F7) settings

This control panel starts the motor with a Y/D starter, which means that the motor starts in Y mode with reduced voltage on the windings. A consequence of the low voltage is that the current is reduced. This means that the size of the main fuse does not need to be as big as in a DOL starter (DOL = Direct On Line).

To calculate the motor overload (F7) protector

- Set F7 to 58% of the motor rated load current in delta mode. The motor rated load current is available on the motor marking plate.

Example:

The motor rated load current on the motor marking plate in delta mode is 63,0 Ampere. Set F7 to $63,0 \times 0,58 = 36,54$ Ampere.

Motor	
Typ XXXX	
3 - Mot.	Nr. XXXXX-XX
Δ Y 400/690 V	63,0/36,5 A
S1	37 kW
	cos φ 0,91
	2970 rpm
	50 Hz
Iso. KL F	IP 54
	t
XXXXX - XXXX XXXX	

Motor overload protector (F7) settings

Trip class (10), 15, 20	Reset (manual) / Auto	37 kW 9-45 A	45-55 kW 18-90 A	Customer setting
10	Manual	Default = 9	Default = 18	

Power supplies	Motor
380 V, 50/60 Hz	Motor voltage Star /Delta Y 690 V / D 400 V
400 V, 50 Hz	Motor voltage Star /Delta Y 690 V / D 400 V
230 V, 50 Hz	Motor voltage Star /Delta Y 400 V / D 230 V
230/460 V, 60 Hz	Motor type IEC -3-12-YY / DD -Y/D
460 V, 60 Hz	Special 12 lead motor is used. Y-Start / D -RUN
220 V, 60 Hz	The same motor is used as to 460V YY-Start / DD -Run. A separate document is needed to connect this motor.

4.4.10 Y/D Timer relay setting (K4T)

By using a Y/D starter, the motor start current is reduced to 30 % of a DOL started motor. In addition, the motor start torque is reduced to 25 % of a DOL started motor.

Applications with a load torque higher than 50% of the motor rated torque will not be able to start using the star-delta starter.

In VACs and RBUs startup valves reduce the torque needed to start the motors.

The Y/D starter contains three contactors and a timer relay that controls the contactor activation sequence.

Default start time is 15 seconds.

$1m=60s$, Desired start time = 15 s, $\rightarrow 15 s/60=0,25$

A too long motor start time heats up the motor. If the motor start time is too short, then the motor will not reach its upper rpm and cause high current pulses when it switches over to delta running mode.

Y/D timer relay K4T settings

Default minutes switch	Default turn 0-1,0	Custom desired start time
1m	0,25	
Custom minutes switch	Custom turn 0-1,0	
m		s

4.4.11 PTC Sensor

If the control panel is equipped with a PTC sensor relay (F8), the control system will not accept that the sensor relay input has an open circuit.

If the VAC/RBU electrical motor has a built-in PTC sensor, it is recommended that it be connected to the control system.

If the VAC/RBU electrical motor does not have a PTC sensor, it is necessary to plug in a resistor at terminal X1: 139 and X1: 140 to simulate a PTC resistor. An appropriate resistor value is 1000 Ohm.

Overload relay and the PTC relay share the same alarm.

PTC relay auto resets when power is off.

When the PTC relay is triggered by high temperature in the motor, the system shuts off and when turning off the power to open the door, there is no sign that the relay has been triggered. Motor overload relay shall be manually reset.

So after an alarm, and opening the door, if the motor overload relay is not tripped, it would be the PTC that has caused the alarm.

4.4.12 Installation of control signals

 • In the electrical diagram, note which external components are connected to the control panel.

• Always secure that the installation is performed according to local regulations and standards. See [Chapter 2 Safety](#).

• Be aware that 0V AC/DC supply is connected to ground. Wires supplying sensors and solenoids will short circuit the 24V supply if it connects to ground, and cause fuses F4 or F5 to interrupt.

A control signal has a voltage range of 0-30V AC/DC, and it is mainly connected to terminal X1:1 -> X1:xx. Its components are outside of the control panel.

Size and colour of the control signal wire are stated in the Electrical wiring diagram.

Terminal X1 is for maximum 2,5 mm² wires. It is recommended to use a 0,5 mm² wire combined with an end cap.

4.4.13 To do before powering up the control panel

Verify and perform the following:

- 1 The motor and control panel is installed according to the Electrical Installation Instructions.
- 2 The control panel is properly grounded.
- 3 The input power (Mains) voltage matches the T1 Transformer input voltage settings.
- 4 The input power (Mains) voltage is connected to the main switch Q1 terminals and is tightened as specified in the Tightening Torque for Cable Connection table. See [4.6 Electrical installation tables](#).
- 5 The motor cable W1 is connected to the motor protector and F7 is tightened as specified in the Tightening Torque for Cable Connection table. See [Section 4.4.15 Electrical installation tables](#).
- 6 The motor cable W2 is connected to contactor F7 and is tightened as specified in the Tightening Torque for Cable Connection table. See [Section 4.4.15 Electrical installation tables](#).
- 7 The motor cables W3-W4 is correctly connected to the motor terminals and tightened.
- 8 Perform a PE continuous test-on, to ensure that the PE wires are correctly connected.
- 9 Visually inspect and clean up the cabinet from foreign objects such as drill shavings, nuts bolts, cable/wiring peeling residuals etc.

4.4.14 Power up of control panel

It is preferable to power up the control panel before any control cable is connected except the PTC and the maintenance switch control cable. Then it is possible to test the 24V AC/DC supply output without any accidental short circuits from control cables.

Before powering up the panel, check all power connections and check that control transformer T1 is connected to the same voltage as control panel power voltage supply.

Before turning on the voltage, always measure the incoming voltage to verify that the control panel's control transformer gets the correct voltage.

Mains voltage is accessible for measurement on Q1 incoming terminals.

When the power voltage is verified versus the T1 control transformer, it is okay to switch on Q1.

- Close the control panel door and turn on the main switch.
- Fill in the table below after the power switch has been turned on.
- Switch off Q1.
- Connect the control cables labelled W101 -> WXX to the correct terminals according to the Electrical wiring diagram.

T1 Transformer secondary output voltage

Measured value (T1)	Available in cabinet type	Measured value
Supply voltage cable (003)	STD, EX	Volt
24 V DC output (T1)	STD	Volt
24 V AC output (T1)	STD, EX	Volt

4.4.15 Electrical installation tables

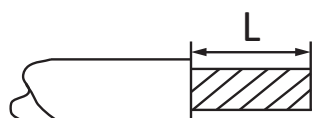

Tightening torque for earth bus bar clamp

Size [kW]	Type	Screw tightening torque [Nm]	Max wire peeling length = L [mm]
37, 45, 55	ZB 4 0,5-4,0 mm ² , screw M3	0,5-1,0	16
37	ZB 6 1,5-10 mm ² , screw M4	1,2-2,4	19
37, 45, 55	ZB 16 2,5-16 mm ² , screw M4	1,2-2,4	19
45, 55	ZB 35 16-50 mm ² , screw M6	2,5-5,0	19

Tightening torque for cable connection

Control panel	Main switch (Q1)	Motor protection (F7)	Contactor (K2)	(Q1)	(F7)	(K2)
Size	Tightening torque for cable connection [Nm]			Type of screws - Bolt - Hex		
EX 37 kW	2,5-3	28	2,5-3,5	M6/PZ2	M8 Hex	PZ2
EX 45 kW	2,5-3	28	4,5-6,0	M6/PZ2	M8 Hex	Hex
EX 55 kW	9,5-10	28	4,5-6,0	M12/SW6	M8 Hex	Hex

Cable and peeling dimensions

Control panel	Max wire Size (Q1) [mm ²]	Peeling length = L (Q1) [mm]	Max wire size (F7) [mm ²]	Peeling length = L (F7) [mm]	Max wire size (K2) [mm ²]	Peeling length = L (K2) [mm]
EX 37 kW	4-50	13,5-15,0	10-150	15,0	2,5-25	15,0
EX 45 kW	4-50	13,5-15,0	16-185	15,0	2,5-50	15,0
EX 55 kW	10-185	15,0	16-185	15,0	2,5-50	15,0

T1 Primary protection auto fuse F2 setting

Size	230 V	400 V	460 V
EX 37 kW	1,3 A	1 A	1 A
EX 45-55 kW	1,6 A	1,25 A	1 A

T1 Secondary protection (fuse) slow

Size	F4 slow	F5 slow	F6 fast
EX 37 kW	Auto 6 A	Auto 6 A	1 A
EX 45-55 kW	Auto 6 A	Auto 16 A	1 A

4.5 Connect FlexFilter

When all electrical connections have been made following the steps below to complete the installation:

- 1 Learn how to use the control panel display. See [Chapter 5 Control panel](#).
- 2 Press the Home button and then the Settings button.
- 3 Press either VAC or RBU to select which device is to be connected to the system.
- 4 Use the MACRO in System Setup to complete the installation. See [Section 5.8 380 - System setup: MACRO](#).
- 5 Prepare a commissioning report. See [Section 5.10 701 - Commissioning report](#).

5 Control panel

i The Control panel design and configurations are subject to change without notice. Screenshots, including simulated data visible, are for illustrative purposes only.

5.1 Work procedure for installation

- 1 Identify the main components to be controlled (VAC/RBU, filters, auxiliary equipment).
- 2 Press the Home button on the control panel.
- 3 In the 101 - HOME screen, press the Settings button.
- 4 In the 301 - Settings screen, select whether a VAC or an RBU is connected to the system. Press the System Settings button.
- 5 In the 321 - System settings screen, press the System Setup button.
- 6 In the 380 - Macro screen, select the device to be connected to the system. The control panel will set up a basic configuration. Press the right arrow button to set up a specific configuration for the installation.

5.2 Control panel overview

Start screen with physical buttons

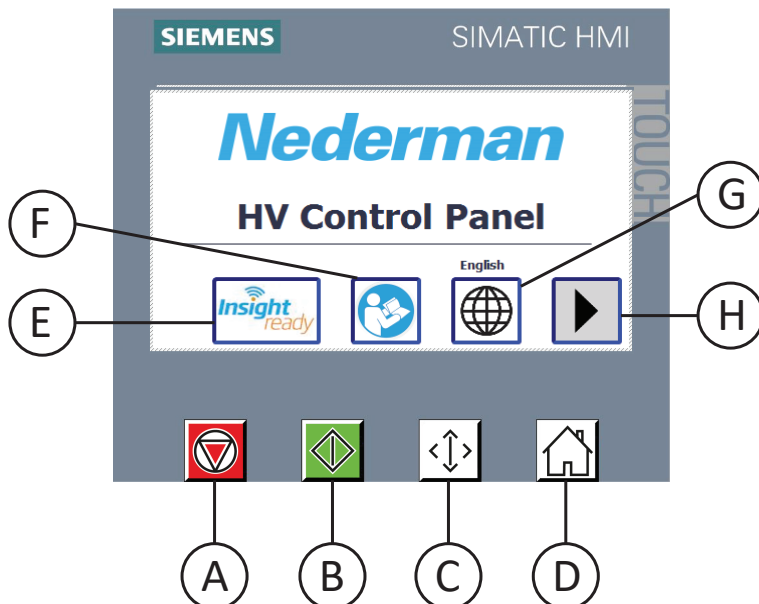

Stop button (A)

Physical button. Press to put the product into Off mode.

Start button (B)

Physical button. Press to put the product into Standby mode to wait for a pilot signal. When the pilot signal is active, the product goes into Running mode.

Test start button (C)

Physical button. Acts as a the pilot signal. The system will run for one start stop relay (SSR). A connected RBU will go into idling. A second push will put the RBU into Running mode for a DIR time.

See [Section 5.4 301 - Settings](#).

Home button (D)

Physical button. Press to go to the HOME screen.

Insight ready button (E)

Button on Start screen. A subscription for Nederman Insight is needed. Get feedback on the High Vac filter system status, prevent malfunctions and read reminders of when it is time for service and/or maintenance. For more information please contact your Nederman representative.

Read the manual button (F)

Button on Start screen. Press to show the following text, "Read all product documentation and product identification plate carefully before installation, use, and service of this product".

Change language button (G)

Button on Start screen. Press to change the control panel language. All screens are in English by default.

Right arrow button (H)

Button on Start screen. Press to go to the HOME screen.

5.2.1 Display/Screen navigation

Press the right arrow button to navigate forward to the next screen or the left arrow button to navigate to a previous screen. In some screens, there is not enough space for right and left arrows. From all screens: Press the Home button to go back to the HOME screen.

5.3 HOME screen

The HOME screen consists of two screens: 101 - HOME and 102 - HOME 2.

5.3.1 101 - HOME

This screen displays the maximum number of configured functions:

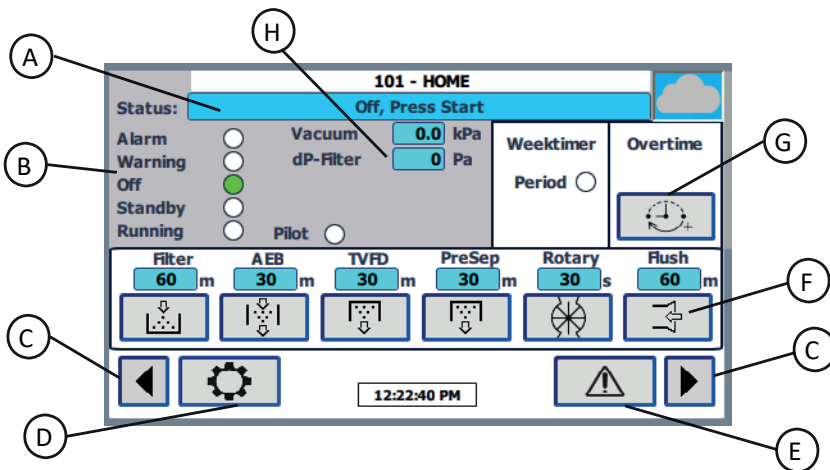

This screen displays no configured functions:

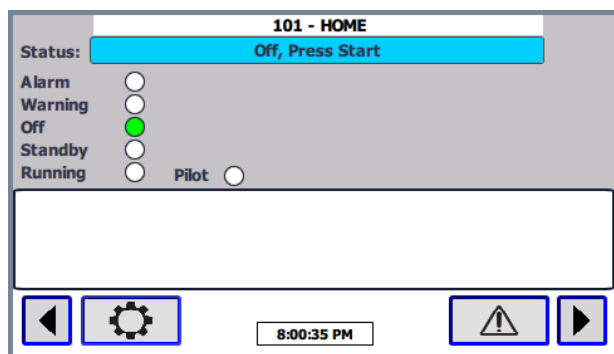

Status field (A)

The status field is used for messages. The following messages are possible:

- Off, Press Start
- Standby, Waiting for pilot signal
- Running
- Start inhibit by remote
- Idling - no vacuum
- Alarm

Indicators (B)

The round indicators on the left show the status of the product, and if there is a warning or an alarm:

- Red if there is an alarm.
- Yellow if there is a warning.
- Green indicates which mode the product is in: Off; Standby or Running.
- The pilot signal is green if it is activated.

Left and right arrow buttons (C)

- Press the left arrow button to go to the Start screen.
- Press the right arrow button to go to the second HOME screen (102 - HOME 2).

Settings button (D)

- Press to go to the Settings screen.

Alarm button (E)

- Press to go to the Alarm screen.

Manual start buttons (F)

Depending on the system configuration, the following buttons are visible:

- Filter: Filter cleaning.
- AEB: Emptying by AEB.
- TVFD: Emptying by TVFD.
- PreSep: Emptying of PreSeparator.
- Rotary
- Flush.

Filter cleaning and flush needs a vacuum, this can only be performed in Running mode. Filter cleaning and emptying of TVFD must not operate simultaneously. There are countdown timers that show the time to the next sequence for the event. A light green button indicates that the timer is in a waiting state.

Weektimer and Overtime/Timer button (G)

A weektimer is used to run the system on a regular weekly schedule. When active it is light green. When the weektimer period expires, the Overtime button becomes green and the overtime timer starts to count down.

- To temporarily add extra time to operate the system, press the Overtime/Timer button or use a remote control switch. Deactivate the overtime by pressing the button for two seconds. See [Chapter 9 Remote Standby/Off/Overtime](#).
- To stop the system, use the Stop button.

Indicators for the weektimer and the Overtime button are made visible by using the Weektime Settings button in the Settings screen. See [Section 5.4 301 - Settings](#).

If a weektimer is not enabled, overtime can be enabled but the Overtime button is displayed as a Timer button. Use the timer to temporarily turn on and operate the system for a set period of time.

Vacuum, SSR and DIR (H)

Vacuum is visible if a sensor is installed and configured. If the pilot signal is deactivated, the DIR (RBU only) and SSR are visible when they count down.

5.3.2 102 - HOME 2

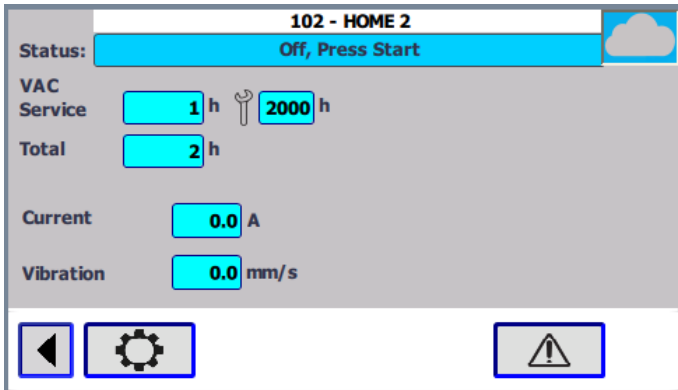

The Status field is the same as in 101 - HOME.

Service shows the number of hours of use since the last service. Total shows the total number of hours the product has been used. The wrench symbol shows the service interval. After service is done, the service timer is reset in Settings. See [Section 5.4 301 - Settings](#).

The motor current is displayed. The present vibration level is displayed if a vibration sensor is installed.

5.4 301 - Settings

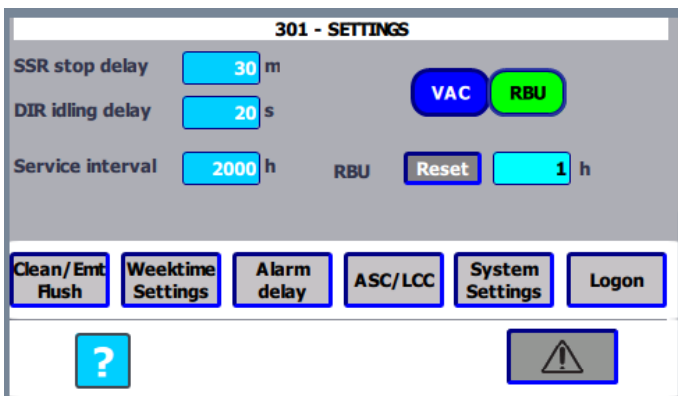

A password is required to configure most parameters and settings. System settings can be accessed without a password for certain functions.

Basic settings are configured such as Clean, Emptying, Flush (Clean/Emit/Flush), Weektime Settings, Alarm delay, ASC/LCC, System Settings, and Logon.

Select whether a VAC or an RBU is connected to the system. If RBU is selected, the DIR idling delay setting also becomes visible.

The question mark button is for the help pages.

5.4.1 341 - Logon

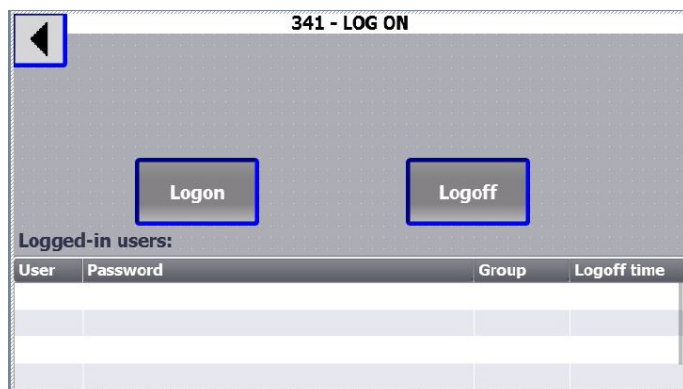

To be able to configure most parameters and settings, a password is required. There are different user levels, each with its own password. The password hierarchy is as follows:

- 1 FieldConfig
- 2 Admin
- 3 User
- 4 Any

Automatic logoff after five minutes of inactivity.

5.4.2 SSR DIR Service timers

When the pilot signal is deactivated or after pressing the Test start button, the SSR and DIR timers are started in parallel.

SSR stop delay

SSR is the time the unit will continue to run without the pilot signal, or after pressing the Test start button. When the SSR time expires, the system goes from Running to Standby mode. To avoid frequent Start/Stop, SSR range is set to a minimum of six minutes.

Settings	Range	Default	Used
SSR	6-9999 m	30	
DIR (only visible for RBU)	0-999 s	20	
VAC / RBU selection	VAC / RBU	VAC	
Service interval	0-9999 h	2000	

DIR Idling delay

DIR is the delay before the start-up valve is deactivated, i.e., it goes to Idling mode after the pilot signal is deactivated. This is only relevant for an RBU unit, and it is only displayed when RBU is selected.

When counting, DIR and SSR are reset by:

- Stop button when running.
- When the Weektimer or Overtime/Timer puts the control panel into Off mode.

Service interval

Service interval sets the interval between service. The service time is displayed under VAC/ RBU and can be re-set.

Reset

- Press Reset for 5 seconds to reset the Service timer to 0.

5.4.3 330 - Settings Filter Cleaning

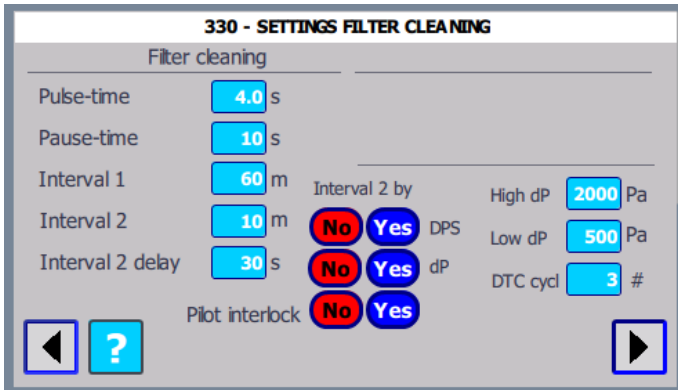

Filter Cleaning	Range	Default	Used
Pulse-time	0-99,9 s	4	
Pause-time	0-999 s	10	
Interval 1	1-9999 m	60	
Interval 2	1-9999 m	30	
Interval 2 delay	0-999 s	20	
Pilot interlock	Yes/No	No	
Interval 2 by Main DPS	Yes/No	No	
Interval 2 by dP	Yes/No	No	
Upstream damper delay before	0-99 s	5	
Upstream damper delay after	0-99 s	10	

Pulse time is the time the cleaning valve is open.

Pause is the time between the pulses in filter 1 and 2 (and 3 and 4 if applicable). If the pause is 0, there are simultaneous pulses.

Interval 1 is the running time between cleaning cycles, from the end of one cycle to start of the next cycle.

The Interval 2 is activated by the main filter DPS after the interval 2 delay. When used, Interval 2 is typically shorter than Interval 1.

When changed to Interval 2, a cleaning sequence is initiated. When interval 2 has expired, the status of DPS is checked. If there is an active signal, then the interval is changed to Interval 1 and a cleaning sequence starts.

With dP, the Interval used is continuously changed from Interval 1 to Interval 2 when the dP has passed Low dP and at High dP it has reached Interval 2. The changing is using a square function.

Filter cleaning is prevented and cannot start during a TVFD emptying sequence. An emptying must be delayed for 10 seconds after a cleaning sequence has ended.

Pilot interlock - No cleaning when the pilot signal is active

- No: Filter cleaning is time controlled during operation, i.e., the default setting.
- Yes: Filter cleaning is prevented until the pilot signal has disappeared.

Provided that a cleaning sequence has been blocked by the pilot interlock a cleaning sequence is started after the pilot signal is deactivated. Cleaning sequences initiated by interval 2 cannot be blocked by the pilot interlock.

Upstream damper

An isolation damper may close due to the cleaning pulse. By closing an upstream damper before the cleaning pulse and delaying its opening until after the sequence, the isolation valve remains open.

5.4.4 331 - Settings - Emptying AEB

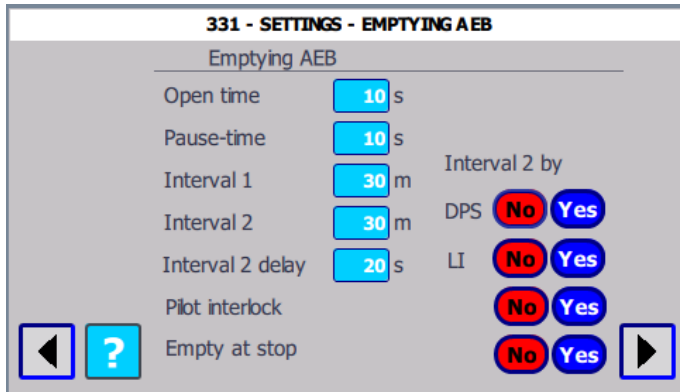

AEB	Range	Default	Used
Open time	0-999 s	10	
Pause-time	0-999 s	10	
Interval 1	1-9999 m	30	
Interval 2	1-9999 m	10	
Interval 2 delay	0-999 s	30	
Pilot interlock	Yes/No	No	
Interval 2 by Main DPS	Yes/No	No	
Interval 2 by Main LI	Yes/No	No	
Empty at stop	Yes/No	No	

Open time is the time the signal to the AEB to be active for opening.

Pause time is the time from closing to the opening the next AEB. If the pause is 0, there are simultaneous opening pulses.

Interval 1 is the running time between emptying sequences. From the end of one cycle to start of the next cycle.

Interval 2 is activated by the DPS if installed for the filter, or the LI, when installed in the bin/hopper of AEB. LI is a common signal for TVFD and Pre-Sep if both are used. The DPS/ LI signals have an adjustable Interval 2 delay time. If Interval 2 is chosen, activate Main DPS and/or LI in the system configuration. See [Section 5.8 380 - System setup: MACRO](#).

When changed to Interval 2, an emptying sequence is initiated. When the interval 2 has expired the status of LI is checked, if there is an active signal, then the interval is changed to Interval 1 and an emptying sequence starts.

Emptying is also possible when manually initiated in OFF and Standby mode, i.e., no vacuum.

Pilot interlock - No emptying when the pilot signal is active

- No: AEB emptying is time controlled during operation, i.e., the default setting.
- Yes: AEB emptying is prevented until the pilot signal has disappeared.

Provided that an emptying sequence has been blocked by the pilot interlock, an emptying sequence is started after the pilot signal is deactivated.

If empty at stop is enabled an emptying sequence will be performed before stopping.

5.4.5 332 - Settings - Emptying TVFD

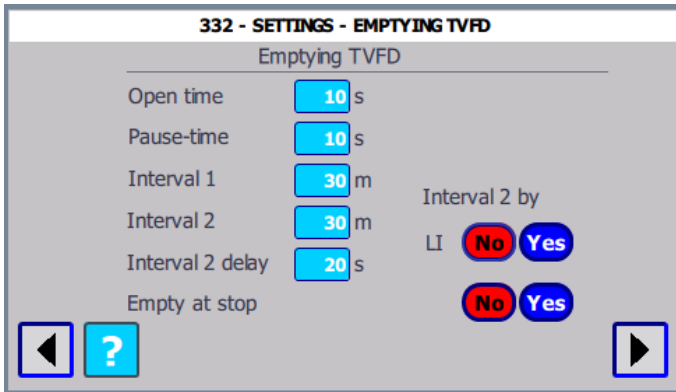

TVFD	Range	Default	Used
Open time	0-999 s	10	
Pause-time	0-999 s	10	
Interval 1	1-9999 m	30	
Interval 2	1-9999 m	10	
Interval 2 delay	0-999 s	30	
Interval 2 by LI	Yes/No	No	
Empty at stop	Yes/No	No	

Emptying by TVFD is delayed 10 seconds after the cleaning sequence has ended. Open time is the time the TVFD lower is open.

Pause time is the time between the closing of the upper to the opening of the lower gate in TVFD and vice versa.

Interval 1 is the running time between emptying sequences. From the end of one cycle to start of the next cycle.

Interval 2 is activated by the LI, when TVFD/hopper is installed. The LI signal has an adjustable response time.

When changed to Interval 2, an emptying sequence is initiated. When the interval 2 has expired the status of LI is checked, if there is an active signal, then the interval is changed to Interval 1 and an emptying sequence starts.

For TVFD EX in HV Control Panel EX, the opening/closing is supervised and interlocked by wire. The Pause time is then the time from closed upper/lower is detected until opening of lower/upper. If there is no detection within 15 seconds, more opening/closing attempts can be made. The number of attempts is limited in Alarm delay settings. See [Section 5.5 351 - 352 - 353 - Alarm Delay](#).

Emptying is also possible when manually initiated in OFF and Standby mode, i.e., no vacuum.

If empty at stop is enabled an emptying sequence will be performed before stopping.

5.4.6 333 - Settings - Emptying Pre-Separator

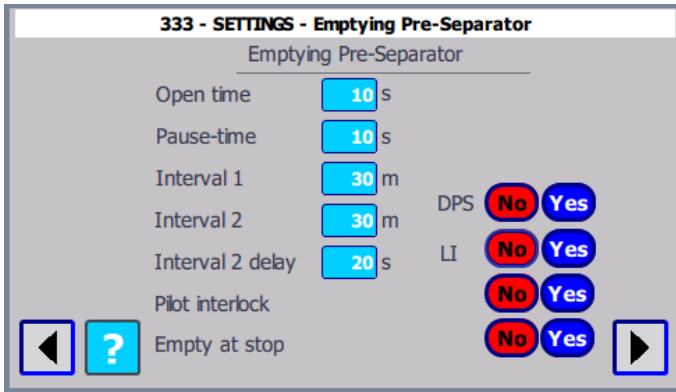

Pre-sep	Range	Default	Used
Open time	0-999 s	10	
Pause	0-999 s	10	
Interval 1	1-9999 m	30	
Interval 2	1-9999 m	10	
Interval 2 delay	0-999 s	30	
Pilot interlock	Yes/No	No	
Interval 2 by Main DPS	Yes/No	No	
Interval 2 by Main LI	Yes/No	No	
Empty at stop	Yes/No	No	

Open time is the time the signal to the Pre-sep is active for opening.

Pause time is the time from closing to the opening the next Pre-sep. If the pause is 0, there are simultaneous opening pulses.

Interval 1 is the running time between emptying sequences. From the end of one cycle to start of the next cycle.

Interval 2 is activated by the LI, when installed in the bin/hopper of AEB. LI is a common signal for TVFD and Pre-Sep if both are used. The LI signal has an adjustable response time. If Interval 2 is chosen, activate Main DPS and/or LI in the system configuration. See [Section 5.8 380 - System setup: MACRO](#).

When changed to Interval 2, an emptying sequence is initiated. When the interval 2 has expired the status of LI is checked, if there is an active signal, then the interval is changed to Interval 1 and an emptying sequence starts.

Emptying is also possible when manually initiated in OFF and Standby mode, i.e., no vacuum.

Pilot interlock - No pre-separator emptying when pilot signal active

- No: Pre-separator emptying is time controlled during operation, i.e., the default setting.
- Yes: Pre-separator emptying is prevented until the pilot signal has disappeared.

Provided that an emptying sequence has been blocked by the pilot interlock, an emptying sequence is started after the pilot signal is deactivated. Emptying sequences initiated by interval 2 cannot be blocked by pilot interlock.

If empty at stop is enabled an emptying sequence will be performed before stopping.

5.4.7 334 -Settings - Emptying rotary valve

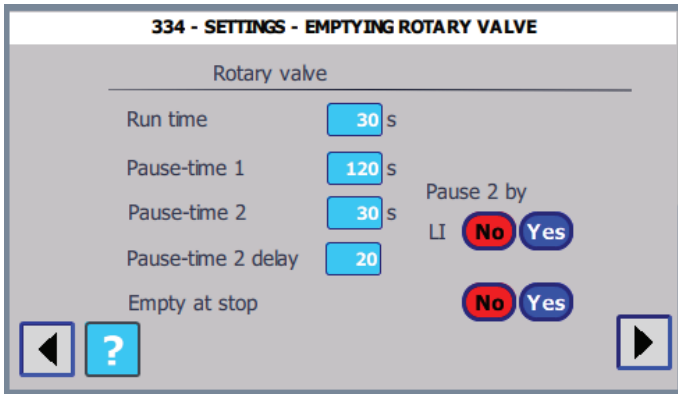

Rotary valve	Range	Default	Used
Run time	0-999 s	30	
Pause-time 1	0-999 s	120	
Pause-time 2	0-999 s	30	
Pause-time 2 delay	0-999 s	30	
Pause 2 by LI	Yes/No	No	
Empty at stop	Yes/No	No	

The rotary valve can run continuously or intermittent. Run time is the time the valve rotates.

Pause time 1 is the time the valve is stopped.

If Pause time = 0 then the valve rotates continuously.

With a level indicator LI in the hopper, the level is supervised and if Pause 2 by LI is Yes, then a level high is detected for Pause-time 2 delay, then the Pause-time 2 will be used.

It will make two sequences of Run + Pause 2 and the return to Pause 1 if no more high level is detected.

If empty at stop is enabled an emptying sequence will be performed before stopping.

5.4.8 335 - Settings - Flushing

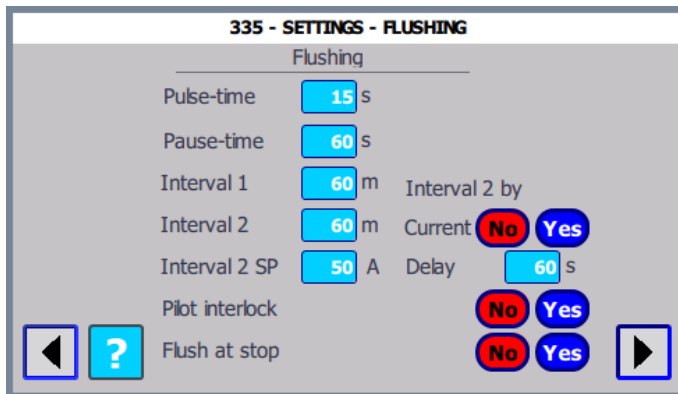

Flushing	Range	Default	Used
Pulse-time	0-999 s	15	
Pause-time	0-999 s	60	
Interval 1	1-9999 m	60	
Interval 2	1-9999 m	30	
Interval 2 SP	0-99 A	50	
Pilot interlock	Yes/No	No	
Flush at stop	Yes/No	No	
Interval 2 by Current	Yes/No	No	
Interval 2 Delay	0-999 s	180	

To reduce the risk of dust accumulation in the duct system, flush valves can be installed in the upstream end of ducts. The flushing function opens these valves in a sequence.

Pause time is the time between the end of the pulse to the next valve pulse.

Interval is the running time between flush cycles, from the end of one cycle to start of the next cycle.

Interval 1 is the running time between flush cycles. From the end of one cycle to start of the next cycle.

Interval 2 is selected with the push button. A shorter interval can be set and used at lower airflows in order to maintain clean ducts.

The motor current is used for activation.

Current below SP for VAC and above SP for RBU trigger Interval 2, after the Interval 2 delay. When switching to Interval 2, flushing will be performed if the time since the last flushing is greater than Interval 2.

It returns to Interval 1 if current other side of setpoint, without flushing. The pilot interlock option disables flushing during the active pilot signal.

Provided that a flushing sequence has been blocked by the pilot interlock a flushing sequence is started after the pilot signal is deactivated. Flushing sequences initiated by interval 2 cannot be blocked by pilot interlock.

DIR and SSR time shall be set long enough to allow proper flushing.

At shutdown ensure that the duct system is purged. By selecting "Flush at stop" = Yes, the flush sequence is executed before normal stops. For an E-stop or a stop because of an alarm, the flushing is omitted.

The flushing is executed at the end of SSR time, or when the system goes from Standby to Off, controlled by the Stop button, Remote control or Weektimer/overtime. For RBU in idling mode, it has to enter non-idling during the Flushing sequence.

5.4.9 311 - 312 - 313 - 314 - Settings - Weektimer

311 - SETTINGS - WEEKTIMER MONDAY

00:00-00:00 = Always off

Enable Weektimer No Yes

Automatic start after Power-off No Yes

Enable Timer/Overtime No Yes

m

Monday	
Start	Stop
h m	h m
1 00 : 00	00 : 00
2 00 : 00	00 : 00
3 00 : 00	00 : 00
4 00 : 00	00 : 00

11/11/2019 9:55:08 AM

312 - SETTINGS - WEEKTIMER TUESDAY-WEDNESDAY

Tuesday		Wednesday	
Start	Stop	Start	Stop
h m	h m	h m	h m
1 00 : 00	00 : 00	00 : 00	00 : 00
2 00 : 00	00 : 00	00 : 00	00 : 00
3 00 : 00	00 : 00	00 : 00	00 : 00
4 00 : 00	00 : 00	00 : 00	00 : 00

11/11/2019 10:02:24 AM

313 - SETTINGS - WEEKTIMER THURSDAY-FRIDAY

Thursday		Friday	
Start	Stop	Start	Stop
h m	h m	h m	h m
1 00 : 00	00 : 00	00 : 00	00 : 00
2 00 : 00	00 : 00	00 : 00	00 : 00
3 00 : 00	00 : 00	00 : 00	00 : 00
4 00 : 00	00 : 00	00 : 00	00 : 00

11/11/2019 10:02:46 AM

314 - SETTINGS - WEEKTIMER SATURDAY-SUNDAY

Saturday		Sunday	
Start	Stop	Start	Stop
h m	h m	h m	h m
1 00 : 00	00 : 00	00 : 00	00 : 00
2 00 : 00	00 : 00	00 : 00	00 : 00
3 00 : 00	00 : 00	00 : 00	00 : 00
4 00 : 00	00 : 00	00 : 00	00 : 00

11/24/2019 7:17:38 PM

Enable Weektimer

An administrator password is required to change the setting.

- Press Yes to enable the Weektimer function. The Weektimer sets the mode from OFF to Standby according to the set start/stop time.

Overtime and Monday are on the first page. Sunday is on the last page.

The Weektimer has four periods per day, if set to 00.00 - 00.00, there is no active period.

Weektimer	Range	Default	Used
Enable Weektimer	Yes/No	No	
Automatic start after Power-off	Yes/No	No	
Enable Timer/Overtime	Yes/No 0-999 m	No	
Overtime setting	0-999 m	120	

00:00 - 01:00 means that the Weektimer starts at midnight and stops at 1:00: AM. 23:00 - 24:00 means it starts at 11:00 PM and stops at midnight 12:00 AM. The stop time must be after the start time. For example, 01:00 - 00:00 is not allowed.

The stop time 24:00 means that the Weektimer will stop at midnight. If the following day starts with 00:00 (hh:mm), the Weektimer will run for two days without stopping.

If the start and stop time are equal, for example, 17:00 - 17:00, it will stop if started manually, or by an overtime period that is counting down.

If during an active Weektimer period, the system is forced to OFF by an Alarm, the system will return to Standby (to Running if there is an active pilot signal), when the Alarm is corrected and the Reset button has been pressed (This is not dependent on the "Automatic start after Power-off).

If stopped remotely, the system will go to Standby/Running when the remote becomes active again. The Stop/Start buttons can also be used during an active period.

Automatic start after Power-off

If it is dangerous to automatically restart the system with the Weektimer after a power-off or Alarm reset, deactivate this function by pressing No. Then the system will not start if there is an active period and it has to be started by the Start button or by toggling the remote. It will still start at the following start time.

If there is no risk, press Yes and the system will be reactivated by the Weektimer and the control panel will go into Standby mode if there is an active period when power returns.

An active overtime period is superseded by a Weektimer period.

Enable Timer/Overtime

Overtime can be used if the Weektimer is activated, even if no time period is set. It can be activated with a remote control input or in the HOME screen. The Timer/Overtime button is only visible if Weektimer is activated. Otherwise, the Timer button is shown in the HOME screen and used to set the system to work for a specific amount of time. The amount of time for the Timer/Overtime is set in this screen

When the Weektimer period is active, overtime is in a waiting mode and its button is light green. When the Weektimer period expires, the Overtime button becomes green and the overtime starts to count down. The activated overtime, in waiting mode, can be deactivated by pressing the button for two seconds. To stop the system, use the Stop button.

Overtime is added to the end of an on-going period. For example, the Weektimer can be set for a period of 08.00 -16.00 during one or more days during the week. If 120 minutes of overtime is needed, press the Timer/Overtime button at 14.00, which will add Standby/ running to 18.00. If the Weektimer button is pressed at 16.30, it will set in Standby / (Running if active pilot) directly and run to 18.30.

5.5 351 - 352 - 353 - Alarm Delay

351 - ALARM DELAY SETTINGS

	Warning	Alarm
Compressed Air Switch (CAS)	15 s	1 m
Level Indicator (LI)	60 s	15 m
Bin Level Indicator (BLI)	60 s	15 m
Control Filter DPS	60 s	1 m
Main Filter DPS	60 s	15 m

Navigation: [Left Arrow] [?] [Right Arrow]

352 - ALARM DELAY SETTINGS

	Warning	Alarm
NS-switch on	30 m	10 m
TVFD open/close attempts	2 #	5 m
Rotary valve fault Rotary valve sensor	15 s	5 m

Navigation: [Left Arrow] [?] [Right Arrow]

Alarm delay	Range Warning / Alarm	Default Warning / Alarm	Used
CAS	0-999s / 0-999m	15 s / 1 m	
Level Indicator (LI)	0-999s / 0-999m	60 s / 15 m	
Bin Level Indicator (BLI)	0-999s / 0-999m	60 s / 15 m	
Control Filter DPS	0-999s / 0-999m	1 s / 1 m	
Main Filter DPS	0-999s / 0-999m	15 s / 15 m	
NS-switch on	0-999s / 0-999m	30 m / 10 m	
TVFD open/close attempts	1-9 # / 0-99 m	2# / 5 m	
Rotary valve fault	- / 0-99 m	- / 5 m	
Rotary valve sensor	0-99 s	15 s	

Delay times for warnings and the following delay times for alarms. Without proper rotation, warnings and alarms are triggered after the delays. Warnings are reset automatically.

Alarms need to be reset manually.

TVFD EX may open/close a few times if there is a problem and the position sensors do not indicate this action within 15 seconds. If no success, the TVFD EX will not move and a warning is triggered. After the Alarm delay, the Alarm is triggered and the system is stopped.

If a Rotary valve is equipped with a rotation sensor, the PLC can detect if the valve is not rotating.

353 - ALARM DELAY SETTINGS - Vacuum - dP - Vib

Vacuum 1 dP Vibration

Vacuum 2 Warning Alarm

Vacuum low kPa s

dP Filter H Pa s

dP Filter HH Pa s m

Vibration H mm/s s

Vibration HH mm/s s m

Alarm delay	Range Warning / Alarm	Default Warning / Alarm	Used
Vacuum low	0-99 kPa	15	
dP Filter H	9999 Pa	3000	
dP Filter HH	9999 Pa	4000	
Vibration H	99.9 mm/s	6.3	
Vibration HH	99.9 mm/s	8	
Vacuum warning delay	0-999 s	60	

5.6 336 - 337 - ASC and LCC (only VAC)

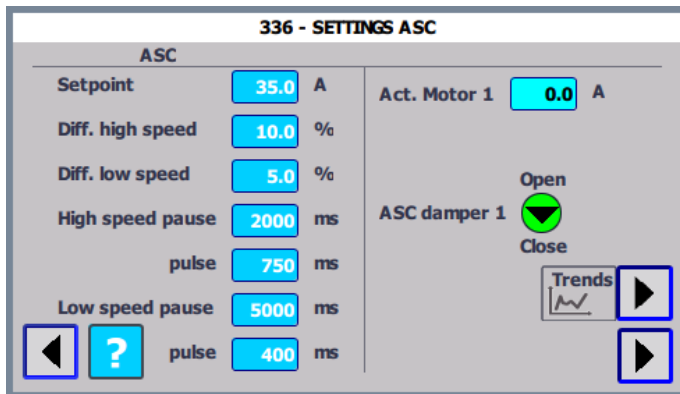

A VAC has a risk of “pumping” at low airflow, thus the airflow is kept, by false air, high enough to avoid this. The motor current is used as the control parameter.

This means that the PLC measures the current and controls the ASC motor damper in the VAC, to maintain a minimum current equal to the setpoint. The damper motor is controlled with pulses for opening and closing. The pulses are controlled with the times in this page. The pulse and pause are set depending on the current difference in percent. With a difference less than “Difference low speed” there are no pulses.

Actual motor current is displayed. An indicator showing opening/closing signals in real time will improve understanding.

The Setpoint shall be adjusted for the actual VAC. Typical setpoint for VAC 20 2500-4000 is 35 A at 400 V. For VAC 20 1500 the setpoint is 27 A. See the VAC 20 instruction manual.

There is a button for a Trends diagram. The Trend diagram is used for diagnostic purpose.

ASC	Range	Default	Used
ASC	Range	Default	
Setpoint	0-99,9 A	35 A	
Diff. high speed	0-99,9%	10,0%	
Diff. low speed	0-9,9%	5,0%	
High speed Pause / Pulse	0-9999/0-9999 ms	2000 / 750 ms	
Low speed Pause / Pulse	0-9999/0-9999 ms	5000 / 400 ms	

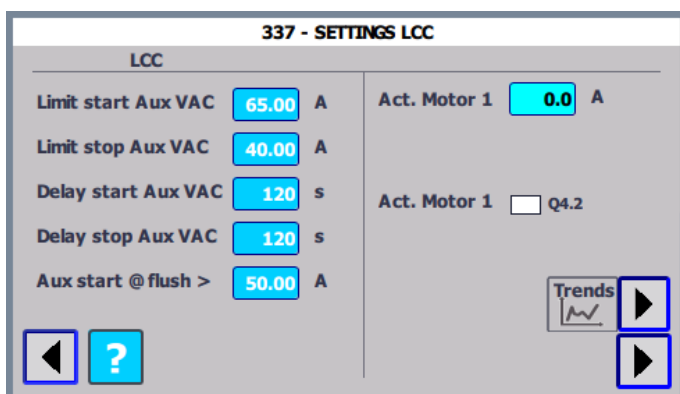

An auxiliary VAC unit will be started when VAC current load reaches “Limit start Aux VAC” and will stop once it decreases to “Limit stop Aux VAC”. Starting and stopping of auxiliary units will be delayed by its corresponding delay setting.

If the VAC current load is greater than the current set in "Aux start @ flush" an auxiliary VAC unit will start prior to flushing in order to achieve a greater airflow.

LCC	Range	Default	Used
Limit start Aux VAC	0-99 A	65 A	
Limit stop Aux VAC	0-99 A	40 A	
Delay start Aux VAC	0-999 s	120 s	
Delay stop Aux VAC	0-999 s	120 s	
Aux start @ flush	0-99 A	50 A	

5.7 321 - System settings

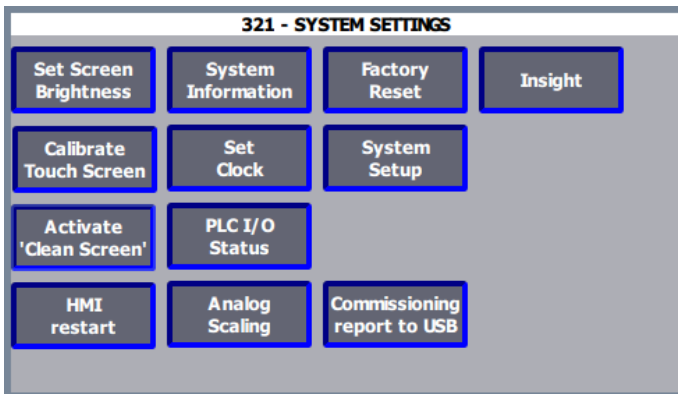

The following five functions are accessible at the user level:

Set Screen Brightness

The screen brightness can be set to a value between 0% and 100%.

Calibrate Touch Screen

If necessary, adjust the calibration to make sure that the correct item is selected when pressing on the screen.

Activate Clean Screen

This function disables the touch surface in order to clean it.

System information

Lists the version for the product and its software.

PLC I/O Status

This screen is for diagnostic purposes.

To access other buttons, an installer or administrator password is required.

5.7.1 HMI restart

This is a system function and used for a restart of the control panel display in order to enter control functions.

5.7.2 323 - Set Time

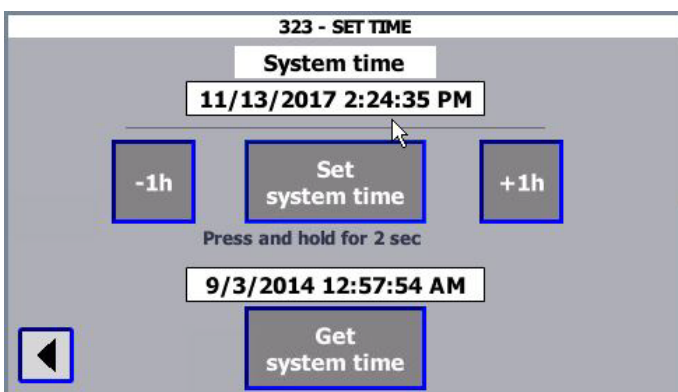

To set the clock

- 1 Press the "Get system time button" to get the time from the PLC.
 - 2 Press on the lower date/time field and edit the date and time.
 - 3 Press the "Set system time" button for 2 seconds to set the time.
- To adjust the clock for summer or wintertime, press the plus button for 2 seconds to go forward one hour for summertime, or the minus button for 2 seconds to go back one hour for wintertime.

5.7.3 322 - Factory reset

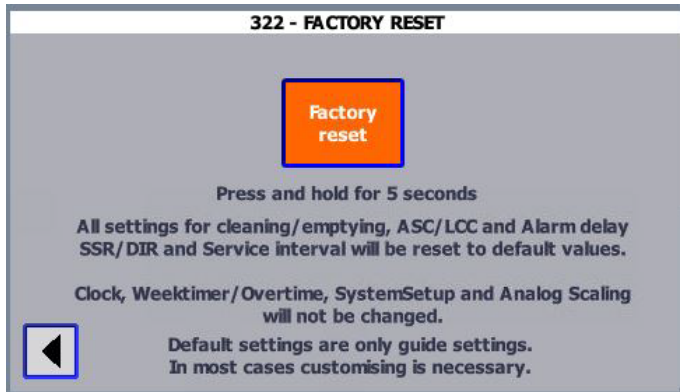

A factory reset will set all settings for cleaning/emptying, ASC/LCC, Alarm delay, SSR/DIR and Service Interval to the default values.

Clock, Weektimer, Overtime/Timer, System Setup and Analog Scaling will not be changed.

To do a factory reset

- Press and hold the Factory reset button for five seconds to do a factory reset.

The word "DONE" is displayed above the Factory reset button when the reset is ready. Default settings are only guide settings. In most cases, customizing is necessary.

5.7.4 401 - 403 - PLC I/O Status

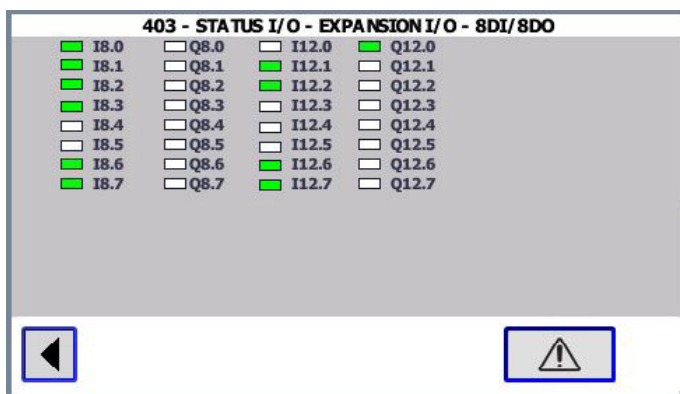
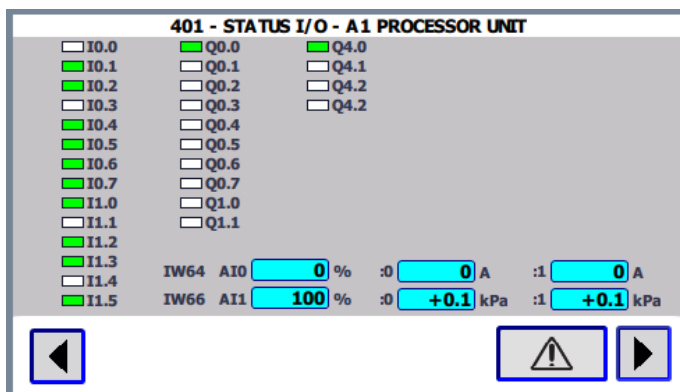

These pages are for diagnostic purposes.

The indicators show the status of inputs and outputs of the PLC. Green is an active signal.

5.7.5 361 - 362 - 363 - Analog Scaling

361 - ANALOG SCALING - AI 0:0 - Current

Actual values analog inputs
 Input 0 V % A Wait

Manual Calibration
 Value at 10V A Save
 Value at 0V A Save

Measured Calibration
 Value at signal high A Save
 Value at signal low A Save

Calculation values
 Signal high V Eng. value high A Activate Calibration
 Signal low V Eng. value low A

Factory reset

362 - ANALOG SCALING - AI 0:1 - Vibration

Actual values analog inputs
 Input 0 V % mm/s Wait

Manual Calibration
 Value at 10V mm/s Save
 Value at 0V mm/s Save

Measured Calibration
 Value at signal high mm/s Save
 Value at signal low mm/s Save

Calculation values
 Signal high V Eng. value high mm/s Activate Calibration
 Signal low V Eng. value low mm/s

Factory reset

363 - ANALOG SCALING - AI 1:0 - Vacuum

Actual values analog inputs
 Input 0 V % kPa Wait

Manual Calibration
 Value at 10V kPa Save
 Value at 0V kPa Save

Measured Calibration
 Value at signal high kPa Save
 Value at signal low kPa Save

Calculation values
 Signal high V Eng. value high kPa Activate Calibration
 Signal low V Eng. value low kPa

Factory reset

The PLC has two analogue inputs. To double the number of possible signals, a multiplexing relay (K22) is installed that alternates the signals to the inputs every 10 s.

The analogue inputs are 0-10V. AI0 are predetermined for current measurement of ASC, and for vibration measurement by an external sensor.

AI1 is used for optional vacuum measurements, if two vacuum sensors are used, the dP Filter is calculated. Optionally a dP sensor can be used.

There are two methods for calibration, manual and measured.

- Manually calibrate by setting values of the output signal at input signal 0 and 10V.
- With measured calibration, you get a signal from the sensor at a low and at a high value and write in the corresponding values from the actual measurements of Current or Vacuum. For measured calibration, proper instruments are needed for current and vacuum.

The current-sensor is nominal 0...10V / 0...100A. However, the PLC input has low impedance and 100A will be decreased to 8V, so the corresponding 10V signal becomes then $100 \cdot 10 / 8 = 125$ A for scaling.

The vacuum sensor normally used is 0..10V / - 40...0 kPa. Since it is known as "Vacuum", only positive values are used, so 40...0 kPa.

At the top of the screen is the actual signal and value with present scaling.

To do a factory reset

- Press and hold the button for 5 seconds to do a reset to factory default values.

To do an Analog Scaling

- 1 Press the button "Activate Calibration". It becomes Yellow/Black blinking.
- 2 Using the manual method: Set new values and press Save for each.
- 3 Using the measurement method: Apply a low and high signal and measure the corresponding current/vacuum.
 - VAC/RBU stopped: current signal low and current = 0A ; Vacuum signal is high (10V) and vacuum = 0 kPa. Write in values and press Save.
 - VAC/RBU running in situations for creating maximum current/vacuum, then high current signal (V) and high current (A), respectively. Low vacuum signal (V) and high vacuum (kPa). Write in values and press Save.
- 4 When finished press the "Activate Calibration" to start using the new calibration.

Check the calibration by comparing actual values with corresponding new measurements. After a calibration, it might be necessary to look over settings for ASC and vacuum warnings.

5.8 380 - System setup: MACRO

-  • Make sure to document any changes that are made to the initial configuration in case there is a need for technical support from Nederman.
- FieldConfig password is needed to change settings in screens 380 to 400.
- Screen 380 - Macro below shows a 45 kW or a 55 kW EX model. There are fewer configuration possibilities with the 37 kW EX model.

The system setup MACRO simplifies the installation process. But each installation is different, so the items selected are different in each of the different configuration screens. See the examples below.

To use the MACRO

- 1 Select the system MACRO by pressing the Home button > Settings > System settings > System setup.
- 2 In the 380 - MACRO screen, select the device to be connected to the system. When the device has been selected, the control panel sets up a basic configuration.

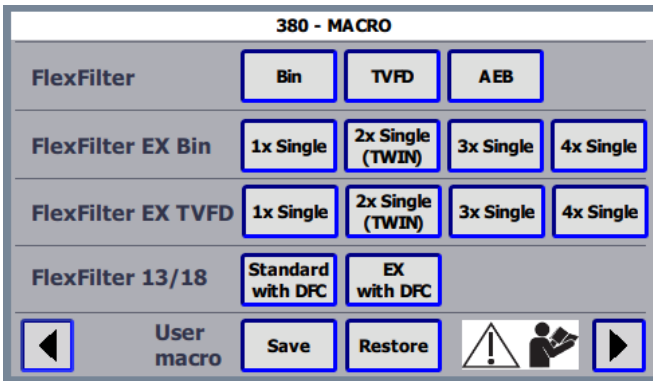

- 3 Press the right arrow button to go to the following pages to set up system specific configurations for the installation.

Example

In screen 381, Main DPS and LI have been chosen since an Interval 2 is to be used. Items that have not been activated are red or OFF while activated items are green. See [Section 5.4 301 - Settings](#).

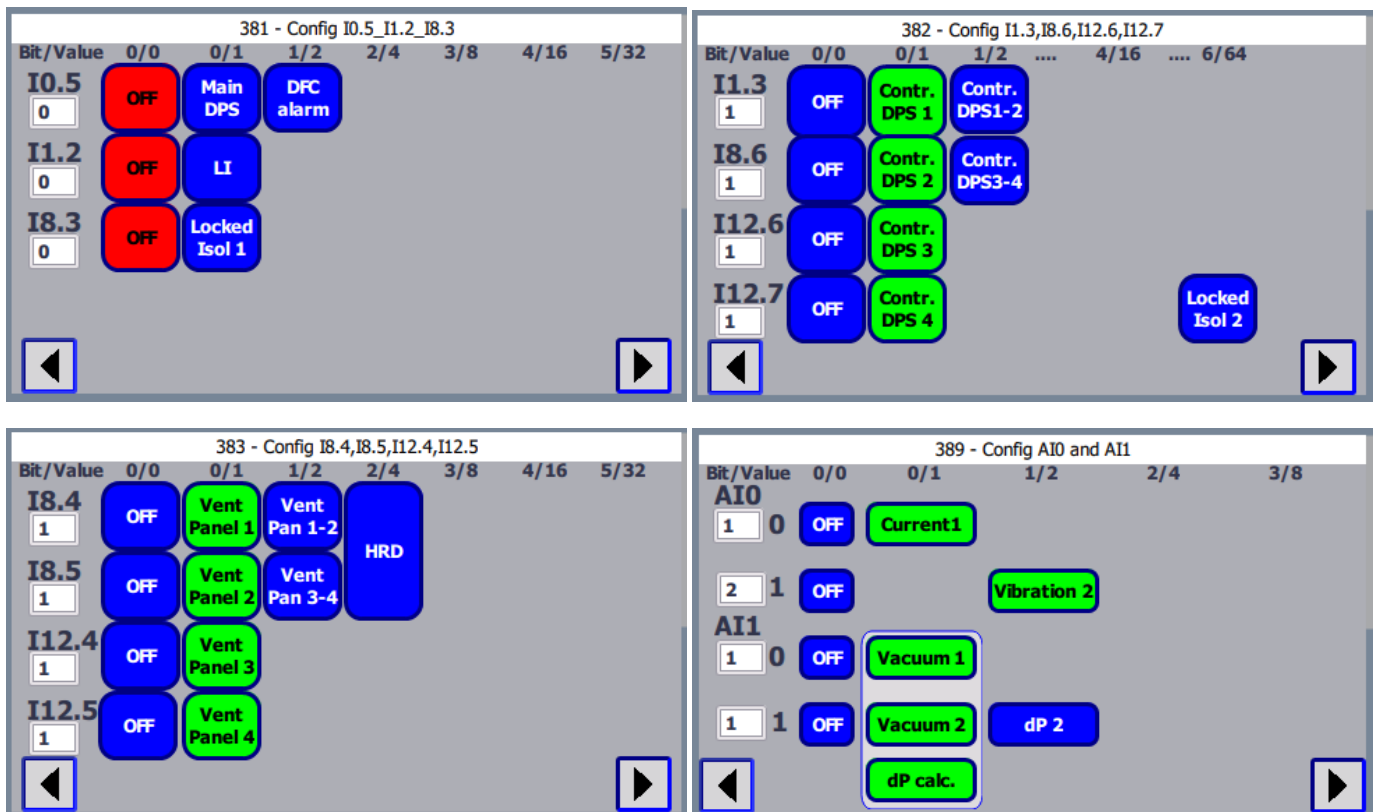

HV Control Panel EX Insight

The image displays eight configuration screens, each showing a set of bit values and their corresponding functions. The screens are arranged in a 4x2 grid. Each screen has a title and a 'Bit/Value' header. The functions are represented by buttons, some of which are highlighted in green.

Screen	Config	Bit/Value	Function	Color
391	Config K13-K14	0/0	OFF	Blue
391	Config K13-K14	0/1	Clean 1	Green
391	Config K13-K14	1/2	AEB 1	Blue
391	Config K13-K14	6/64	Flush 11	Blue
391	Config K13-K14	7/128	PreSep 1	Blue
391	Config K13-K14	1	OFF	Blue
391	Config K13-K14	1	OFF	Blue
391	Config K13-K14	1	Clean 2	Green
391	Config K13-K14	1	AEB 2	Blue
391	Config K13-K14	12	Flush 12	Blue
391	Config K13-K14	2	PreSep 2	Blue
392	Config K16-K17	0/0	OFF	Blue
392	Config K16-K17	0/1	Clean 3	Blue
392	Config K16-K17	1/2	AEB 3	Blue
392	Config K16-K17	2/4	TVFD 1	Blue
392	Config K16-K17	3/8	TVFD EX 1 with Position sensors	Green
392	Config K16-K17	6/64	Flush 13	Blue
392	Config K16-K17	7/128	PreSep 3	Blue
392	Config K16-K17	8	OFF	Blue
392	Config K16-K17	8	OFF	Blue
392	Config K16-K17	8	OFF	Blue
392	Config K16-K17	8	OFF	Blue
392	Config K16-K17	14	Flush 14	Blue
392	Config K16-K17	4	PreSep 4	Blue
393	Config K19-K22	0/0	OFF	Blue
393	Config K19-K22	0/1	ASC for VAC	Green
393	Config K19-K22	3/8	LCC	Blue
393	Config K19-K22	4/16	MUX	Green
393	Config K19-K22	6/64	Flush 5	Blue
393	Config K19-K22	7/128	PreSep 5	Blue
393	Config K19-K22	1	OFF	Blue
393	Config K19-K22	1	OFF	Blue
393	Config K19-K22	0	OFF	Red
393	Config K19-K22	0	Clean 5	Blue
393	Config K19-K22	8	OFF	Blue
393	Config K19-K22	8	OFF	Blue
393	Config K19-K22	7	Flush 7	Blue
393	Config K19-K22	7	PreSep 7	Blue
393	Config K19-K22	6	Flush 6	Blue
393	Config K19-K22	6	PreSep 6	Blue
394	Config K24-K25	0/0	OFF	Blue
394	Config K24-K25	0/1	Clean 7	Blue
394	Config K24-K25	1/2	AEB 5	Blue
394	Config K24-K25	2/4	TVFD 2	Blue
394	Config K24-K25	3/8	TVFD EX 2 with Position sensors	Green
394	Config K24-K25	6/64	Flush 15	Blue
394	Config K24-K25	7/128	PreSep 9	Blue
394	Config K24-K25	8	OFF	Blue
394	Config K24-K25	8	OFF	Blue
394	Config K24-K25	8	OFF	Blue
394	Config K24-K25	8	OFF	Blue
394	Config K24-K25	16	Flush 16	Blue
394	Config K24-K25	10	PreSep 10	Blue
395	Config K26-K29	0/0	OFF	Red
395	Config K26-K29	0/1	Clean 9	Blue
395	Config K26-K29	1/2	Up stream Damp.1	Blue
395	Config K26-K29	2/4	Flush 1	Blue
395	Config K26-K29	3/8	Flush 2	Blue
395	Config K26-K29	4/16	Flush 3	Blue
395	Config K26-K29	6/64	Flush 4	Blue
395	Config K26-K29	0	OFF	Red
395	Config K26-K29	0	OFF	Red
395	Config K26-K29	0	OFF	Red
395	Config K26-K29	0	OFF	Red
396	Config K30-K31	0/0	OFF	Red
396	Config K30-K31	0/1	TVFD EX 3 with Position sensors	Blue
396	Config K30-K31	1/2	AEB 7	Blue
396	Config K30-K31	2/4	AEB 8	Blue
396	Config K30-K31	3/8	TVFD 3	Blue
396	Config K30-K31	7/128	PreSep 11	Blue
396	Config K30-K31	0	OFF	Red
396	Config K30-K31	0	OFF	Red
396	Config K30-K31	0	OFF	Red
396	Config K30-K31	0	OFF	Red
396	Config K30-K31	12	PreSep 12	Blue
397	Config K32-K33	0/0	OFF	Blue
397	Config K32-K33	2/4	TVFD 4	Blue
397	Config K32-K33	3/8	TVFD EX 4 with Position sensors	Green
397	Config K32-K33	4/16	Flush 9	Blue
397	Config K32-K33	5/32	Flush 10	Blue
397	Config K32-K33	6/64	Flush 9	Blue
397	Config K32-K33	7/128	Flush 10	Blue
397	Config K32-K33	8	OFF	Blue
397	Config K32-K33	8	OFF	Blue
397	Config K32-K33	8	OFF	Blue
397	Config K32-K33	1	OFF	Blue
398	Config K34-K37	0/0	OFF	Red
398	Config K34-K37	0/1	Up stream Damp.2	Blue
398	Config K34-K37	7/128	Up stream Damp.2	Blue
398	Config K34-K37	0	OFF	Red
398	Config K34-K37	0	OFF	Red
398	Config K34-K37	0	OFF	Red
398	Config K34-K37	0	OFF	Red

The final configuration can be saved as a user MACRO in screen 380-MACRO and be reported in the commissioning report.

5.9 Configuration of analogue inputs

The PLC has two analogue inputs 0-10 V, these are multiplexed and each accepts two inputs.

AI:0 is used for internal current sensing (0..10 V) and external vibration measurement (4..20 mA). AI:1 is used for two external vacuum sensors (-40..0 kPa 0..10 V).

5.10 701 - Commissioning report

701 - Comm.Report

Commissioning reports generation

1. Power off HMI and insert an USB memory stick (FAT32) into the HMI, and power on again.
2. Generate reports with buttons
3. Power off HMI and remove USB stick, and power on again.
4. Open Commissioning Reports in Excel, Convert Text to columns with comma as delimiter

Shop Setup
 Configuration
 Settings
 Weektimer
 Calibration
 Status

Success
 Failed, See Alarm history

- When a system is installed and commissioned, make a commissioning report, which includes all settings. Either write down all of the settings or transfer a copy of the settings from the control panel display to a USB memory stick.
- Keep this report and list of settings for any future maintenance and service.

6 Remote emptying

In addition to the emptying start buttons in the control panel display, a remote button can be installed by the unit to be emptied. Connect the remote to I1.4, terminals 55-56.

The function will initiate emptying of AEB/TVFD and PreSep when applicable.

7 On/StandBy/Start

The system can be set to Standby with:

- Start button on the control panel display.
- Weektimer.
- Overtimer. If no active Weektimer period, then activation of Overtime will set Standby.
- Remote, when activation after five seconds in Off mode.

Prevention of start

If there are active alarms, these alarms must be reset before a restart. There is no automatic restart when pressing "Reset", and an additional press on the Start button is requested. Press the Start button.

If Remote start input is not active, then the following message is displayed, "Start inhibit by Remote".

If the Weektimer valid period has a start time before the control panel is turned on, then press the Start button if the automatic start is not selected. See [Section 5.4.9 311 - 312 - 313 - 314 - Settings - Weektimer](#).

Y/D start

The HV Control Panel Standard uses the Y/D start method.

During Y-mode, the motor power is reduced by a start-up valve, and not activated. Also, the ASC is closed. When changing to D-mode the start-up valve and the ASC is enabled.

The D-mode is supervised by the PLC. If D-mode is not indicated after start within 60 seconds (normal start 15 seconds) then there is an alarm.

8 Stop/Off

There are eight stop functions in a hierarchy:

- 1 E-stop: Alarm and go to OFF.
- 2 Alarm: Go to OFF.
- 3 Remote StandBy/Off/Overtime (I0.6): Go to OFF (5-second delay if "Weektimer/ Overtime is enabled).
- 4 Stop/Off button: Go to OFF.
- 5 Weektimer period expired (If no overtime, go to OFF).
- 6 Overtime expired (go to OFF; overtime is reset by Weektimer Start).
- 7 SSR time expired: Go to Standby.
- 8 Pilot signal (I0.0) deactivated (in parallel with the Test Start button released) delayed by SSR time.

9 Remote Standby/Off/Overtime

This input (I0.6, terminals 5-6) has combined functionality.

If this input is not used as a remote control, it must be linked (active). Then OFF/Standby is controlled from the control panel display buttons and the weektimer.

Control from superior system/machine/manual twist button is maintained

If Weektimer or Timer is not enabled, the input can be used as a simple OFF/Standby: At activation (positive edge), it goes to Standby. If it is maintained active, the system stays in Standby mode. At deactivation, signal inactive, the system goes to OFF superseding other start signals. The start is inhibited by remote.

Remote control weektimer/overtime

With Weektimer and Overtime/Timer, the input is used for remote control of Weektimer and for requesting Overtime.

A twist button OFF-ON + Time (spring back) is recommended. A white indication lamp from the output for On/Standby lamp (Q1.1 /K18, terminals 89-90) is used as an indication.

The lamp indicates the status "Standby" by a fixed light (Running when pilot active or SSR counting). It also indicates an alarm by 1 Hz blinking. The start is inhibited by remote.

When switched to OFF (deactivation of input), status is with a 5-second delay, and then it is set to OFF. At the turn to ON (activation), it will check for Weektimer period. If there is an active period, then it is set to Standby, if not in active status, it is still OFF.

From position ON, a short twist to + Time is an Overtime/Timer request and is indicated by a burst of lamp blinks. If in an active Weektimer period, Overtime is in a waiting state and is indicated by the lamp blinking every 5 seconds. In the control panel display, the Overtime/Timer button is light green.

During an active Weektimer period, i.e., in a waiting state, an active Overtime request is indicated by the lamp blinking.

- To deactivate the Overtime request, make a new twist to 2 seconds which will be followed by a burst of blinks as confirmation.

If there is no active Overtime request, the lamp will have a fixed light without blinking every 5 seconds.

- To stop and reset an active Overtime period (outside any Weektimer period), switch to OFF for more than 5 seconds and then switch to ON again in order to be prepared for the Weektimer control. Or press the Stop button on the HV Control Panel.

10 FlexFilter 13/18 with DFC-08M

DFC-08M - 24VDC is power supplied by the control Panel.

Start signal to the unit will use the "Running", see terminal 17-18 in the electrical diagram.

Alarm signal from DFC-08M will be connected to I0.5, via one of the following pairs X1: 49-50, X1: 187-188, X1: 189-190 or X1: 191-192. Configured in MACRO. See [Section 5.8 380 - System setup: MACRO](#).

The alarm signal generates a warning in the control panel and after the alarm delay, it generates an alarm and stops.

11 Alarms



There is a list of alarms and warnings. When an alarm or warning is triggered, Alarms shows the alarm or warning and when it was triggered. "A" indicates an alarm and "W" indicates a warning.

Warnings will disappear automatically when the problem is corrected. Alarms can only be reset after logon.

- Press the House symbol at the bottom right to go to the Alarm history that lists alarms and warnings in chronological order. Scroll down to see earlier entries.



11.1 Alarm and Warning relays and lamp Levels

The system has the following modes of indications:

- Normal
- Warning
- Alarm

Lamp on door

The orange lamp has three modes:

- Normal (No light).
- Warning (Blinking 0,5 Hz).
- Alarm (Fix light.)

Alarm relay

SPDT relay, external voltage max 48 V, 6 A (inductive 1 A).

Relay energized at no-Alarm (will be de-energized when an alarm is on, or if there is a power failure).

Warning relay

SPDT relay, external voltage max 48 V, 6 A (inductive 1 A)

Relay energized at Warning and also at Alarm. Only a power failure or OFF can be detected when both Alarm and Warning relay is not energized.

Dedicated output for E-stop

For the control panel, there is a dedicated 24 V DC output to Red Flash (LED or xenon) active at E-stop, e.g. a venting panel is open, or a fire alarm is tripped, but not when there is an alarm for another reason.

11.2 Lists of possible alarms and warnings

Alarm list

Nr	Type	Alarm text	Standard	EX
A001	Alarm	Fire alarm	X	X
A002	Alarm	Safety relay/Emergency stop	X	X
A003	Alarm	HRD fault		X
A004	Alarm	HRD activated		X
A008	Alarm	Compressed air < 3 bar	X	X
A009	Alarm	DFC-08M alarm	X	X
A010	Alarm	High filter system dP	X	X
A011	Alarm	N-S switch on	X	X
A013	Alarm	BLI Dust bin level high	X	X
A014	Alarm	LI Dust level high	X	X
A017	Alarm	VAC1 Bearing temp high	X	X
A018	Alarm	VAC1 Motor overload/overtemp	X	X
A019	Alarm	VAC1 Maintenance switch off	X	X
A020	Alarm	VAC1 Start command no response	X	X
A033	Alarm	Control Filter 1 high dP	X	X
A034	Alarm	Filter 1 Venting panel open		X
A035	Alarm	Isolation valve 1 locked		X
A036	Alarm	Filter 1 TVFD failed		X
A040	Alarm	Control Filter 1-2 high dP		X
A041	Alarm	Filter 1-2 Venting panel open		X
A045	Alarm	Rotary valve 1 fault (not ready)		X
A046	Alarm	Rotary valve 1 no rotation		X

Nr	Type	Alarm text	Standard	EX
A049	Alarm	Control Filter 2 high dP		X
A050	Alarm	Filter 2 Venting panel open		X
A052	Alarm	Filter 2 TVFD failed		X
A061	Alarm	Rotary valve 2 fault (not ready)		X
A062	Alarm	Rotary valve 2 no rotation		X
A065	Alarm	VAC2 Not ready		X
A066	Alarm	VAC2 Fault		X
A068	Alarm	VAC2 No response		X
A081	Alarm	Control Filter 3 high dP		X
A082	Alarm	Filter 3 Venting panel open		X
A083	Alarm	Isolation valve 2 locked		X
A084	Alarm	Filter 3 TVFD failed		X
A088	Alarm	Control Filter 3-4 high dP		X
A089	Alarm	Filter 3-4 Venting panel open		X
A093	Alarm	Rotary valve 3 fault (not ready)		X
A094	Alarm	Rotary valve 3 no rotation		X
A097	Alarm	Control Filter 4 high dP		X
A098	Alarm	Filter 4 Venting panel open		X
A100	Alarm	Filter 4 TVFD failed		X
A109	Alarm	Rotary valve 4 fault (not ready)		X
A110	Alarm	Rotary valve 4 no rotation		X
A129	Alarm	TVFD 1 upper and lower slides opened		X
A130	Alarm	TVFD 2 upper and lower slides opened		X
A131	Alarm	TVFD 3 upper and lower slides opened		X
A132	Alarm	TVFD 4 upper and lower slides opened		X
A145	Alarm	RBU1 Overheating	X	X
A146	Alarm	RBU1 Motor overload/overtemp	X	X
A147	Alarm	RBU1 Maintenance switch off	X	X

Nr	Type	Alarm text	Standard	EX
A148	Alarm	RBU1 No start response	X	X

Warning list

Nr	Type	Warning text	Standard	EX
W404	Warning	Vacuum level very low	X	X
W405	Warning	Vacuum level low	X	X
W406	Warning	Vacuum level high	X	X
W408	Warning	Compressed air < 3 bar	X	X
W409	Warning	DFC-08M alarm	X	X
W410	Warning	High filter system dP	X	X
W411	Warning	N-S switch on	X	X
W413	Warning	BLI Dust bin level high	X	X
W414	Warning	LI Dust level high	X	X
W417	Warning	VAC1 Time for service	X	X
W433	Warning	Control Filter 1 high dP	X	X
W436	Warning	Filter 1 TVFD upper not opening		X
W437	Warning	Filter 1 TVFD upper not closing		X
W438	Warning	Filter 1 TVFD lower not opening		X
W439	Warning	Filter 1 TVFD lower not closing		X
W440	Warning	Control Filter 1-2 high dP		X
W445	Warning	Rotary valve 1 fault (not ready)		X
W446	Warning	Rotary valve 1 no rotation		X
W449	Warning	Control Filter 2 high dP		X
W452	Warning	Filter 2 TVFD upper not opening		X
W453	Warning	Filter 2 TVFD upper not closing		X
W454	Warning	Filter 2 TVFD lower not opening		X
W455	Warning	Filter 2 TVFD lower not closing		X
W461	Warning	Rotary valve 2 fault (not ready)		X
W462	Warning	Rotary valve 2 no rotation		X

Nr	Type	Warning text	Standard	EX
W481	Warning	Control Filter 3 high dP		X
W484	Warning	Filter 3 TVFD upper not opening		X
W485	Warning	Filter 3 TVFD upper not closing		X
W486	Warning	Filter 3 TVFD lower not opening		X
W487	Warning	Filter 3 TVFD lower not closing		X
W488	Warning	Control Filter 3-4 high dP		X
W494	Warning	Rotary valve 3 no rotation		X
W497	Warning	Control Filter 4 high dP		X
W500	Warning	Filter 4 TVFD upper not opening		X
W501	Warning	Filter 4 TVFD upper not closing		X
W502	Warning	Filter 4 TVFD lower not opening		X
W503	Warning	Filter 4 TVFD lower not closing		X
W510	Warning	Rotary valve 4 no rotation		X
W513	Warning	ASC1 not opening	X	X
W514	Warning	ASC1 not closing or duct system leakage	X	X
W515	Warning	ASC2 not opening		EX45-55
W516	Warning	ASC2 not closing or duct system leakage		EX45-55
W545	Warning	RBU1 Time for service	X	X

12 Troubleshooting



WARNING! Risk of personal injury

Always read [Chapter 2 Safety](#) before installation, use, service, or troubleshooting of this product.

If there is an alarm or warning in the control panel, the first step is to make sure that the system has been properly configured and that the installations settings made in the sections above are correct. See [Chapter 11 Alarms](#).

If this does not solve the problem, see the service and troubleshooting guide for the specific component that has caused the alarm or warning.

13 Maintenance



WARNING! Risk of personal injury

Always read [Chapter 2 Safety](#) before installation, use, service, or troubleshooting of this product.

13.1 Routine inspection and service

Follow the list in the service protocol to routinely inspect, repair or replace worn and damaged parts on the inside and outside of the product. See [Chapter 18 Appendix B: Service protocol](#).

13.2 Cleaning

External cleaning of the cabinet is made annually or when it has become soiled.

- 1 Clean the transparent front with a gentle cleaning agent. Do not use acetone or other strong detergents. Remove dust that has settled on the top of the cabinet.

- 2 Do not use the cabinet top as a deposit place for any tools or other equipment. Keep the environment around the cabinet free from debris or other equipment.

14 Spare parts



CAUTION! Risk of equipment damage

Use only Nederman original spare parts and accessories.

Contact your nearest authorized distributor or Nederman for advice on technical service or if you require help with spare parts. See also www.nederman.com.

14.1 Ordering spare parts

When ordering spare parts always state the following:

- The part number and control number (see the product identification plate).
- Detail number and name of the spare part (see www.nederman.com).
- Quantity of the parts required.

15 Recycling

The product has been designed for component materials to be recycled. Its different material types must be handled according to relevant local regulations. Contact the distributor or Nederman if uncertainties arise when scrapping the product at the end of its service life.

16 Acronyms

Term	Definition
AEB	Automatic Emptying of Bin
ASC	Anti Surge Control (valid for VAC)
BLI	Bin Level Indicator (in dust receptor - Bin or Big-Bag)
CAS	Compressed Air Switch (> 3-4 bar = OK = closed contact)
DIR	Delay Idling Relay
DOL	Direct On Line
DPS	Differential Pressure Switch (at main filter or control filter)
EX	Explosive atmosphere - related to Combustible Dust (ATEX, NFPA)
HMI	Human Machine Interface, i.e., the control panel display
HRD	High Rapid Discharge EX Suppression system
IS	Intrinsic safe circuit for EX
LCC	Load Control Current - to start another HV Control Panel Standard (valid only for VAC)
MS	Maintenance switch (signal contact closed when MS is ON)
PLC	Programmable Logic Controller
PLL	PU Load Control Current - same as LCC but starts a simple "Power Unit" - Y/D starter
PreSep	Pre Separator
PTC	Thermistor in motor (PTC-relay needed in Control Panel for supervision)
RBU	Root Blower Unit
SSR	Start Stop Relay
TAV	Nederman (Tedak) Automatic Valve (normally closed, NC, but as upstream damper normally open, NO and close with the signal)
TIA	Siemens Total Integrated Automation - development portal
TVFD	Twin Valve Feed-out Device
VAC	Vacuum Unit (twin impeller fan)
Y/D	Start method Star-Delta

19 Appendix C

- Take a picture of the label pasted on the gateway and send to insight-setup@nedeman.com together with the following information:

Company Name	
Address	
Country	
Order number	
Router serial information	

Nederman

www.nederman.com