

OSF 4x3000 SM

FibreDrain® oil smoke collector for continuous operation.



Nederman FibreDrain® OSF oil smoke collectors are designed to handle large amounts of neat oil mist during continuous operation. They are developed with focus on high efficient filtration together with low maintenance cost.



Nederman FibreDrain® OSF 4x3000 has as standard 3 filter-stages where the first 2 stages consists of filter cassettes with Nederman's FibreDrain® technology. Nederman have a wide range of different types of filters to suit many different kind of applications. The third stage consists of a HEPA filter in filter class H13 with an efficiency of 99,95% for MPPS according to EN1822. All tower built Nederman FibreDrain® OSF units are prepared for use of pre filter. OSF 4x3000 have a top mounted radial fan.

- Three filter stages, optional pre-filter
- Gauges for reading of pressure drop over each filter stage
- Drain: 4 off 1 1/2"
- Non-vibration fan suspension system

Product name	OSF 4x3000 SM
Standard	2009/125/EC
Volume (for shipping) (m³)	25
Noise level (dB(A))	< 70 dB(A) @1,5 m from service side with optional fan enclosure and silencer
Protection class	IP55
Filter efficiency (%)	99,95
Installation	Indoor
Material	Sheet metal, painted both in- and outside.
Filter cleaning method	Self-Draining
Working pressure (kPa)	Max 4600 Pa
Capacity (max airflow m³/h)	12000
Operating Temperature	60 deg C (limited by filter)
Power Voltage (V)	400/690
Frequency (Hz)	50
No of phases	3
Number of filter elements	30
Amperage (A)	26/15,1
Colour	NCS-S 1005 B20G
Weight (kg)	2800
Power (kW)	15
Note	Plus 10 optinal filter element.









OSF 4x3000 SM

Image	Description	Model
	OSF 4x3000, Inlet flange 560x560mm left. Drain 4 x 1 1/2" Female.	12401149*
	OSF 4x3000, Inlet flange 560x560mm right. Drain 4 x 1 1/2" Female.	12401150*

*Plus 10 optional filter element.

OSF 4x3000 SM

	Accessory	Part No
	Drain pump box, 50 Hz, 10 litre/min at 5m, including controller	12400054*
	Drain container with piping	12400764**
	Optional FibreDrain Pre Filter ORF 610x610x96 mm.	12400039
	FibreDrain Filter 1 OSF; 600x600x292 mm	12400006
	FibreDrain Filter 2 OSF; 600x600x292 mm	12400007
	HEPA DCM H13 610x610x292 mm	12400012
	Inlet adapter OSF 4x3000, OMF 3x4000, OMF 2x6000	12401163
	Extension structure OSF 4x3000	12401168
	Fan enclosure 3 filters in depth	12401160
	Silencer 90° Ø 630 mm	12401159
	Drain pump box, 50 Hz, 10 litre/min at 10m, including controller	12401330
	OSF/OMF Instruction manual for mounting system for electric components	12401342
	OMF/OSF/MQL mounting system for electrical components	12401341

*Drain connection must be elevated min 200 mm from pump box support level

**Drain connection must be elevated min 420mm from container support level

OSF 4x3000 SM

OSF 4x3000 assembly of options:



OSF 4x3000 SM

OSF 4x3000 complete with options:

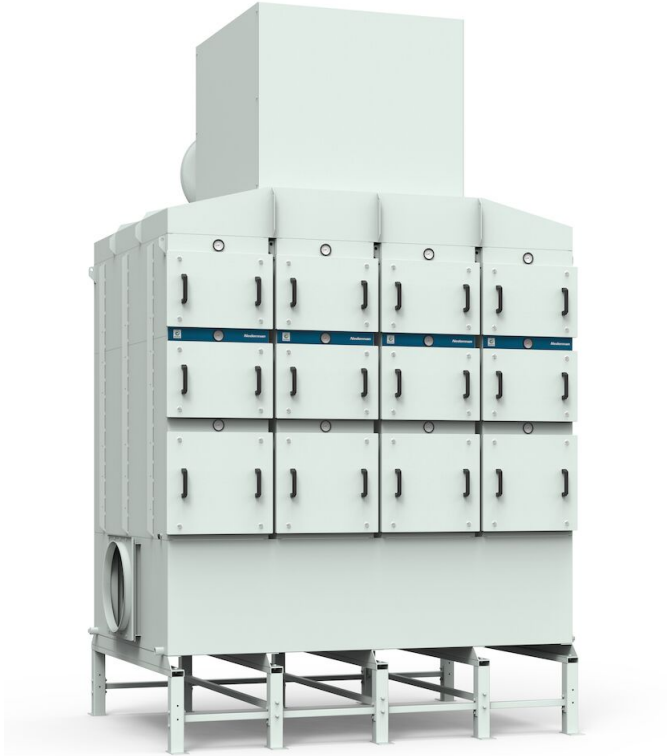

OSF 4x3000 SM

OSF 4x3000 with inlet from left side:

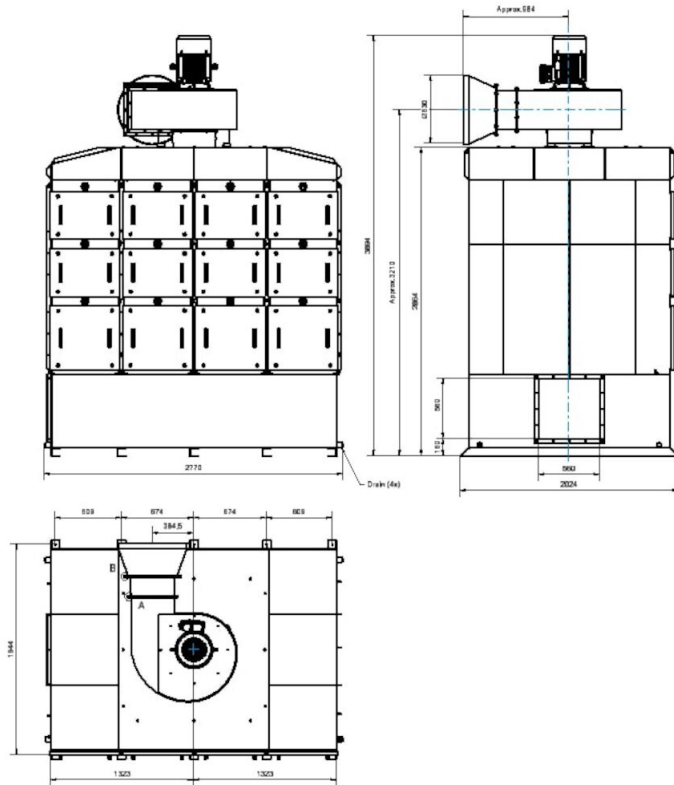

OSF 4x3000 SM

OSF 4x3000 with inlet from right side:

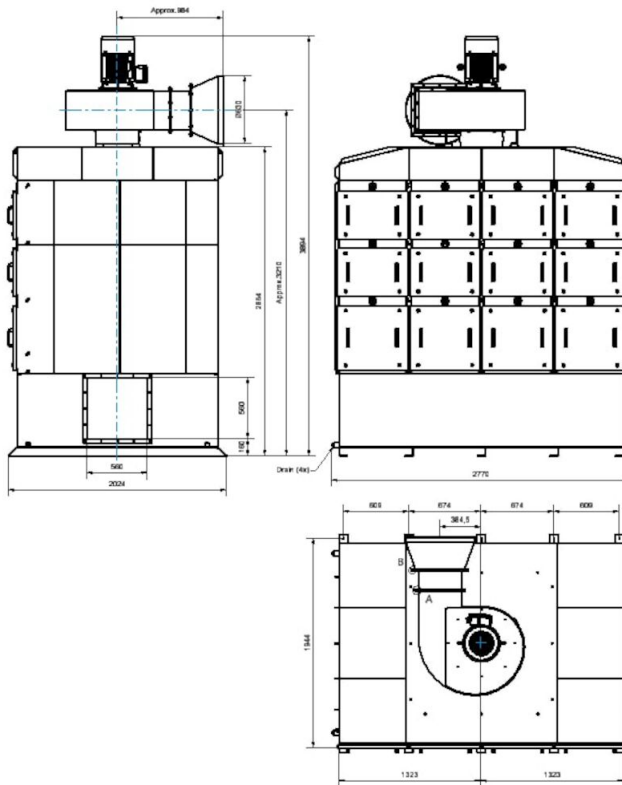

OSF 4x3000 SM

Dimension Inlet Adapter OSF4x3000_OMF3x4000_2x6000,
accessory 12401163:

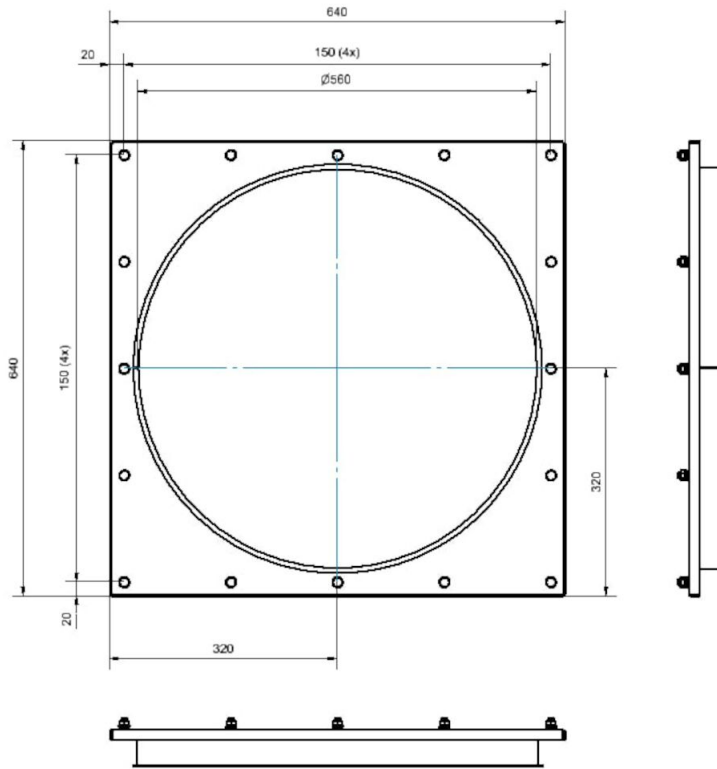

Dimension Extension Structure OSF4x3000,
accessory 12401168:

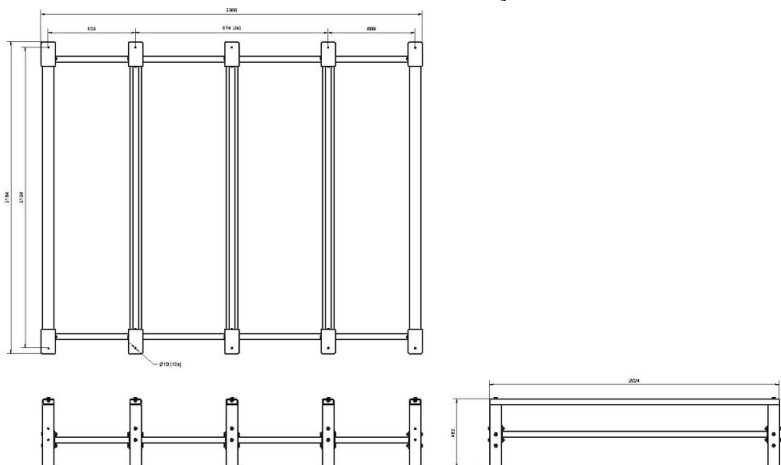

OSF 4x3000 SM

Dimension Fan Enclosure OSF4x3000_OMF2x6000,
accessory 12401160:

