

Air powered series

Ab115 - NE32, S50 wo/accessories

42111581

Original instruction manual

EN INSTRUCTION MANUAL

Translation of original instruction manual

CS NÁVOD K OBSLUZE

DA BETJENINGSVEJLEDNING

DE BEDIENUNGSANLEITUNG

ES MANUAL DE INSTRUCCIONES

FI KÄYTTÖOHJEET

FR MANUEL D'INSTRUCTION

HU FELHASZNÁLÓI KÉZIKÖNYV

IT MANUALE D'ISTRUZIONE

NL HANDLEIDING

NO BRUKSANVISNING

PL INSTRUKCJA UŻYTKOWANIA

RO MANUAL DE UTILIZARE

RU РУКОВОДСТВО ПО ЭКСПЛУАТАЦИИ

SV ANVÄNDARMANUAL

Declaration of conformity

EN English

Declaration of conformity

We, AB Ph. Nederman & Co., declare under our sole responsibility that the Nederman product:

Ab units: Ab014, Ab105, Ab106, Ab112, Ab113, Ab115, Ab116, Ab117, Ab139, Ab206, Ab216, Ab218, Ab221, Ab305, Ab306, Ab315, Ab316, Ab405, Ab415, Ab425, Ab426, Ab450, Ab460, Ab470, Ab471, Ab500, Ab510, Ab570, Ab580, Ab581, Ab600, Ab700, Ab710, Ab720, Ab721 and Ab722 with accessories to which this declaration relates, are in conformity with the following:

Directives

2006/42/EC, 87/404/EEC.

Standards

EN 286-1, EN ISO 12100.

DA Dansk

Overensstemmelseserklæring

Vi, AB Ph. Nederman & Co. erklærer som eneansvarlige, at produkterne fra Nederman:

Ab-enhederne: Ab014, Ab105, Ab106, Ab112, Ab113, Ab115, Ab116, Ab117, Ab139, Ab206, Ab216, Ab218, Ab221, Ab305, Ab306, Ab315, Ab316, Ab405, Ab415, Ab425, Ab426, Ab450, Ab460, Ab470, Ab471, Ab500, Ab510, Ab570, Ab580, Ab581, Ab600, Ab700, Ab710, Ab720, Ab721 og Ab722 og tilbehøret dertil, som denne erklæring vedrører, er i overensstemmelse med bestemmelserne i følgende direktiver og standarder:

Direktiver

2006/42/EC, 87/404/EEC.

Standarder

EN 286-1, EN ISO 12100.

ES Español

Declaración de Conformidad

Nosotros, AB Ph. Nederman & Co., declaramos bajo nuestra única responsabilidad que el producto Nederman:

Unidades Ab: Ab014, Ab105, Ab106, Ab112, Ab113, Ab115, Ab116, Ab117, Ab139, Ab206, Ab216, Ab218, Ab221, Ab305, Ab306, Ab315, Ab316, Ab405, Ab415, Ab425, Ab426, Ab450, Ab460, Ab470, Ab471, Ab500, Ab510, Ab570, Ab580, Ab581, Ab600, Ab700, Ab710, Ab720, Ab721 y Ab722 con accesorios, a los que se refiere esta declaración, cumplen con las disposiciones de las siguientes:

Directivas

2006/42/EC, 87/404/EEC.

Normas

EN 286-1, EN ISO 12100.

SV Svenska

Försäkran om överensstämmelse

Vi, AB Ph. Nederman & Co. försäkrar under eget ansvar att Nederman-produkten:

Ab-enheter: Ab014, Ab105, Ab106, Ab112, Ab113, Ab115, Ab116, Ab117, Ab139, Ab206, Ab216, Ab218, Ab221, Ab305, Ab306, Ab315, Ab316, Ab405, Ab415, Ab425, Ab426, Ab450, Ab460, Ab470, Ab471, Ab500, Ab510, Ab570, Ab580, Ab581, Ab600, Ab700, Ab710, Ab720, Ab721 och Ab722 med tillbehör som omfattas av denna försäkran är i överensstämmelse med följande:

Direktiv

2006/42/EC, 87/404/EEC.

Standarder

EN 286-1, EN ISO 12100.

CS Český

Prohlášení o shodě

My, společnost AB Ph. Společnost Nederman & Co. prohlašuje na svou zodpovědnost, že výrobek Nederman:

jednotky Ab: Ab014, Ab105, Ab106, Ab112, Ab113, Ab115, Ab116, Ab117, Ab139, Ab206, Ab216, Ab218, Ab221, Ab305, Ab306, Ab315, Ab316, Ab405, Ab415, Ab425, Ab426, Ab450, Ab460, Ab470, Ab471, Ab500, Ab510, Ab570, Ab580, Ab581, Ab600, Ab700, Ab710, Ab720, Ab721 a Ab722 s příslušenstvími, kterých se toto prohlášení týká, jsou v souladu s těmito předpisy:

Směrnicemi

2006/42/EC, 87/404/EEC.

Normy

EN 286-1, EN ISO 12100.

DE Deutsch

Konformitätserklärung

Wir, AB Ph. Nederman & Co., erklären in alleiniger Verantwortung, dass das Nederman Produkt:

Ab-Einheiten: Ab014, Ab105, Ab106, Ab112, Ab113, Ab115, Ab116, Ab117, Ab139, Ab206, Ab216, Ab218, Ab221, Ab305, Ab306, Ab315, Ab316, Ab405, Ab415, Ab425, Ab426, Ab450, Ab460, Ab470, Ab471, Ab500, Ab510, Ab570, Ab580, Ab581, Ab600, Ab700, Ab710, Ab720, Ab721 und Ab722 mit dem Zubehör, auf das sich diese Erklärung bezieht, den folgenden Normen entspricht:

Richtlinien

2006/42/EC, 87/404/EEC.

Standards

EN 286-1, EN ISO 12100.

FI Suomi

Vaatimustenmukaisuusvakuutus

Me, AB Ph. Nederman & Co., vakuutamme yksinomaan omalla vastuullamme, että Nederman-tuote

Ab-yksiköt: Ab014, Ab105, Ab106, Ab112, Ab113, Ab115, Ab116, Ab117, Ab139, Ab206, Ab216, Ab218, Ab221, Ab305, Ab306, Ab315, Ab316, Ab405, Ab415, Ab425, Ab426, Ab450, Ab460, Ab470, Ab471, Ab500, Ab510, Ab570, Ab580, Ab581, Ab600, Ab700, Ab710, Ab720, Ab721 ja Ab722 sekä niiden lisävarusteet, joihin tämä vakuutus liittyy, täyttävät seuraavat vaatimukset:

Direktiivit

2006/42/EC, 87/404/EEC.

Standardit

EN 286-1, EN ISO 12100.

FR Français

Déclaration de conformité

Nous, AB Ph. Nederman & Co., déclarons sous notre seule responsabilité, que les produits Nederman :

Unités Ab : Ab014, Ab105, Ab106, Ab112, Ab113, Ab115, Ab116, Ab117, Ab139, Ab206, Ab216, Ab218, Ab221, Ab305, Ab306, Ab315, Ab316, Ab405, Ab415, Ab425, Ab426, Ab450, Ab460, Ab470, Ab471, Ab500, Ab510, Ab570, Ab580, Ab581, Ab600, Ab700, Ab710, Ab720, Ab721 et Ab722 et accessoires auxquels cette déclaration s'applique, sont conformes aux directives et normes suivantes :

Directives

2006/42/EC, 87/404/EEC.

Normes

EN 286-1, EN ISO 12100.

HU Magyar

Megfelelőségi Nyilatkozat

Mi, az AB Ph. Nederman & Co. nevében, felelősségünk tudatában kijelentjük hogy a(z)

Ab egységek: Ab014, Ab105, Ab106, Ab112, Ab113, Ab115, Ab116, Ab117, Ab139, Ab206, Ab216, Ab218, Ab221, Ab305, Ab306, Ab315, Ab316, Ab405, Ab415, Ab425, Ab426, Ab450, Ab460, Ab470, Ab471, Ab500, Ab510, Ab570, Ab580, Ab581, Ab600, Ab700, Ab710, Ab720, Ab721 és Ab722, valamint azon kellékek, amelyekre ez a nyilatkozat vonatkozik, megfelelnek az alábbiaknak:

Direktíváknak

2006/42/EC, 87/404/EEC.

Szabványoknak

EN 286-1, EN ISO 12100.

NL Nederlands

Conformiteitsverklaring

Wij, AB Ph. Nederman & Co, verklaren in uitsluitende aansprakelijkheid dat het product van Nederman:

Ab-units: Ab014, Ab105, Ab106, Ab112, Ab113, Ab115, Ab116, Ab117, Ab139, Ab206, Ab216, Ab218, Ab221, Ab305, Ab306, Ab315, Ab316, Ab405, Ab415, Ab425, Ab426, Ab450, Ab460, Ab470, Ab471, Ab500, Ab510, Ab570, Ab580, Ab581, Ab600, Ab700, Ab710, Ab720, Ab721 en Ab722 met toebehoren waarop deze verklaring van toepassing is, in overeenstemming zijn met de volgende:

Richtlijnen

2006/42/EC, 87/404/EEC.

Normen

EN 286-1, EN ISO 12100.

PL Polski

Deklaracja zgodności

My, AB Ph. Nederman & Co., niniejszym oświadczamy na naszą własną odpowiedzialność, że produkty:

jjednostki AB: Ab014, Ab105, Ab106, Ab112, Ab113, Ab115, Ab116, Ab117, Ab139, Ab206, Ab216, Ab218, Ab221, Ab305, Ab306, Ab315, Ab316, Ab405, Ab415, Ab425, Ab426, Ab450, Ab460, Ab470, Ab471, Ab500, Ab510, Ab570, Ab580, Ab581, Ab600, Ab700, Ab710, Ab720, Ab721 i Ab722A wraz z akcesoriami, których dotyczy niniejsza deklaracja, są zgodne z następującymi:

Dyrektywy

2006/42/EC, 87/404/EEC.

Normy

EN 286-1, EN ISO 12100.

RU Русский

Заявление о соответствии

Мы, AB Ph. Nederman & Co., заявляем об исключительной ответственности, что оборудование Nederman:

Устройства Ab: Ab014, Ab105, Ab106, Ab112, Ab113, Ab115, Ab116, Ab117, Ab139, Ab206, Ab216, Ab218, Ab221, Ab305, Ab306, Ab315, Ab316, Ab405, Ab415, Ab425, Ab426, Ab450, Ab460, Ab470, Ab471, Ab500, Ab510, Ab570, Ab580, Ab581, Ab600, Ab700, Ab710, Ab720, Ab721 и Ab722 с дополнительным оборудованием, к которому относится эта декларация, соответствует следующим требованиям:

Директивы

2006/42/EC, 87/404/EEC.

Стандарты

EN 286-1, EN ISO 12100.

IT Italiano

Dichiarazione di conformità

Noi, AB Ph. Nederman & Co., dichiariamo sotto la nostra esclusiva responsabilità che il prodotto Nederman:

Unità Ab: Ab014, Ab105, Ab106, Ab112, Ab113, Ab115, Ab116, Ab117, Ab139, Ab206, Ab216, Ab218, Ab221, Ab305, Ab306, Ab315, Ab316, Ab405, Ab415, Ab425, Ab426, Ab450, Ab460, Ab470, Ab471, Ab500, Ab510, Ab570, Ab580, Ab581, Ab600, Ab700, Ab710, Ab720, Ab721 e Ab722 e relativi accessori, oggetto di questa dichiarazione, sono conformi alle seguenti:

Direttive

2006/42/EC, 87/404/EEC.

Norme

EN 286-1, EN ISO 12100.

NO Norsk

Samsvarserklæring

Vi, AB Ph. Nederman & Co, erklærer på eget ansvar at Nedermans produkt:

Ab-enhetene: Ab014, Ab105, Ab106, Ab112, Ab113, Ab115, Ab116, Ab117, Ab139, Ab206, Ab216, Ab218, Ab221, Ab305, Ab306, Ab315, Ab316, Ab405, Ab415, Ab425, Ab426, Ab450, Ab460, Ab470, Ab471, Ab500, Ab510, Ab570, Ab580, Ab581, Ab600, Ab700, Ab710, Ab720, Ab721 og Ab722 med tilbehør som denne erklæringen gjelder for, er i overensstemmelse med følgende:

Direktiver

2006/42/EC, 87/404/EEC.

Standarder

EN 286-1, EN ISO 12100.

RO Română

Declarație de conformitate

Firma AB Ph. Nederman & Co. declară pe proprie răspundere că produsele Nederman:

unitățile Ab: Ab014, Ab105, Ab106, Ab112, Ab113, Ab115, Ab116, Ab117, Ab139, Ab206, Ab216, Ab218, Ab221, Ab305, Ab306, Ab315, Ab316, Ab405, Ab415, Ab425, Ab426, Ab450, Ab460, Ab470, Ab471, Ab500, Ab510, Ab570, Ab580, Ab581, Ab600, Ab700, Ab710, Ab720, Ab721 și Ab722 cu accesoriile la care se referă prezenta declarație respectă:

Directivele

2006/42/EC, 87/404/EEC.

Standardele

EN 286-1, EN ISO 12100.

AB Ph. Nederman & Co.
P.O. Box 602
SE-251 06 Helsingborg
Sweden



Christian Norman
Technical Manager















Warning

EN		WARNING! Explosion risk. If this unit shall be used for collection of hazardous, explosive or high flammable material, or in areas where such is present, contact your nearest authorized distributor or Nederman for technical advice!
SV		VARNING! Explosionsrisk. Om denna enhet skall användas för uppsugning av hälsovådligt, explosivt eller lättantändligt material – eller i utrymmen där sådant förekommer – kontakta närmaste auktoriserade distributör eller Nederman för teknisk rådgivning!
FI		VAROITUS! Räjähdyksvaara. Mikäli tätä yksikköä käytetään vaarallisten, räjähtävien tai helposti syttyvien materiaalien keräämiseen tai alueilla, joilla tällaisia materiaaleja esiintyy, teknisiä ohjeita on pyydettävä Nedermanin paikalliselta edustajalta!
DE		WARNUNG! Explosionsgefahr. Wenn diese Einheit zur Aufnahme gefährlicher, explosiver oder hochentzündlicher Materialien verwendet bzw. in Bereichen eingesetzt werden soll, in denen diese Materialien vorkommen, wenden Sie sich an einen autorisierten Vertriebspartner in Ihrer Nähe oder an Nederman, um technische Hilfestellung zu erhalten.
DA		ADVARSEL! Eksplosionsfare. Hvis denne enhed skal anvendes til opsugning af farligt, eksplosivt eller meget brandfarligt materiale, eller på steder, hvor sådant materiale forekommer, skal du kontakte din nærmeste autoriserede distributør eller Nederman for at få teknisk rådgivning!
NO		ADVARSEL! Eksplosjonsfare. Hvis denne enheten skal brukes til oppsamling av helsefarlige, eksplosive eller lett antennelige materialer, eller i områder der dette forekommer, må du ta kontakt med din nærmeste autoriserte distributør eller Nederman for teknisk veiledning!
NL		WAARSCHUWING! Explosiegevaar. Indien deze unit zal worden gebruikt voor het afzuigen van gevaarlijk, explosief of sterk brandbaar materiaal of in een omgeving waar explosie- of brandgevaar bestaat, neem dan contact op met uw dichtstbijzijnde erkende distributeur of Nederman voor technisch advies!
HU		FIGYELMEZTETÉS! Robbanásveszély. Ha a berendezést veszélyes, robbanásveszélyes vagy gyúlékony anyagok begyűjtésére használja, illetve olyan területeken használja, ahol ilyen anyagok előfordulnak, akkor műszaki tanácsadásért forduljon a Nederman legközelebbi hivatalos képviselőjéhez.
PL		OSTRZEŻENIE! Zagrożenie wybuchem. Jeśli niniejsza jednostka będzie używana do gromadzenia niebezpiecznego, wybuchowego lub wysoce łatwopalnego materiału, czy też w obszarach, w których taki materiał jest obecny, wówczas, aby uzyskać poradę techniczną, skontaktuj się z najbliższym autoryzowanym dystrybutorem lub firmą Nederman!

ES		<p>ADVERTENCIA: riesgo de explosión.</p> <p>Si pretende utilizar esta unidad para la recoger materiales peligrosos, explosivos o altamente inflamables, o en zonas donde puedan estar presentes, póngase en contacto con su distribuidor autorizado o pida consejo a los técnicos de Nederman.</p>
RO		<p>AVERTIZARE! Pericol de explozie.</p> <p>Dacă acest produs urmează să fie utilizată pentru colectarea unor materiale periculoase, explozive sau inflamabile, ori în zone în care sunt prezente asemenea substanțe, luați legătura cu cel mai apropiat distribuitor autorizat sau cu Nederman pentru indicații tehnice!</p>
IT		<p>AVVERTENZA! Rischio di esplosione.</p> <p>Per l'eventuale utilizzo dell'unità per la raccolta di materiale pericoloso, esplosivo o altamente infiammabile, oppure in presenza di materiale di questo tipo, contattare il distributore autorizzato più vicino o Nederman per un parere tecnico!</p>
FR		<p>AVERTISSEMENT ! Risque d'explosion.</p> <p>Si cet appareil doit être utilisé pour la collecte de matériaux dangereux, explosifs ou très inflammables ou dans les zones où ce type de matériaux est présent, contactez votre distributeur ou Nederman pour des conseils techniques !</p>
CS		<p>VÝSTRAHA! Nebezpečí výbuchu.</p> <p>Bude-li tato jednotka použita ke shromažďování nebezpečného, výbušného nebo hořlavého materiálu nebo v prostorách, kde je takový materiál přítomen, vyžádejte si technickou poradou u nejbližšího oprávněného distributora nebo u společnosti Nederman.</p>
RU		<p>ВНИМАНИЕ! Опасность взрыва.</p> <p>Если данное устройство будет использоваться для сбора опасных, взрывоопасных или легковоспламеняющихся материалов или в зонах, где присутствуют такие материалы, пожалуйста, обратитесь к ближайшему авторизованному дистрибьютору или в компанию Nederman для получения технических рекомендаций!</p>

Warnings and prohibitions

	 Max 8 bar	 230VAC				
EN	Compressed air, max 8 bar	Alternating current	Moving pneumatic cylinder	Unstable	Noise	Crush risk
SV	Tryckluft, max 8 bar	Växelström	Rörlig luftcylinder	Instabil	Oljud	Klämrisk
FI	Paineilma, maks. 8 bar	Vaihtovirta	Liikkuva paineilmasylinteri	Epävakaa	Melua	Puristumisvaara
DE	Druckluft, max. 8 Bar	Wechselstrom	Beweglicher Druckluftzylinder	Instabil	Geräusch	Klemm- gefahr
DA	Trykluft, maks. 8 bar	Vekselstrøm	Bevægelig trykluftscylinder	Ustabil	Støj	Klemfare
NO	Trykkluft, maks. 8 bar	Vekselstrøm	Bevegelig pneumatisk sylinder	Ustabil	Støy	Klemfare
NL	Perslucht, max. 8 bar	Wisselstroom	Bewegende pneumatische cilinder	Onstabiel	Geluid	Beknellingsge- vaar
HU	Sűrített levegő, max. 8 bar	Váltóáram	Mozgó pneumatikus munkahenger	Ingatag	Zaj	Becsípődés veszélye
PL	Powietrze sprężone, maks. 8 bar	Prąd zmienny	Przesuwający się siłownik pneumatyczny	Niestabilność	Hałas	Niebezpieczeń- stwo wciągnięcia
ES	Aire comprimido, máx. 8 bar	Corriente alterna	Cilindro neumático en movimiento	Inestable	Ruido	Riesgo de pel- lizcamiento
RO	Aer comprimat, maximum 8 bari	Curent alternativ	Cilindru pneumatic mobil	Instabil	Zgomot	Risc de prindere
IT	Aria compressa, max 8 bar	Corrente alternata	Cilindro pneumatico in movimento	Instabile	Rumore	Rischio di schiac- ciamento
FR	Air comprimé, max. 8 bars	Courant alternatif	Vérin pneumatique mobile	Instable	Bruit	Risque de pincement
CS	Stlačený vzduch, max. 8 barů	Střídavý proud	Pohybující se pneumatický válec	Nestabilní	Hluk	Nebezpečí přimáčknutí
RU	Сжатый воздух, макс. 8 бар	Переменный ток	Движущийся пневматический цилиндр	Неустойчивое положение	Шум	Опасность за- щемления

				 Max 8 bar		
EN	Do not use caustics	Do not use explosive materials	Do not use hazardous materials	Do not use compressed air over 8 bar	Do not use crane	Do not place unstable
SV	Använd ej frätande material	Använd ej explosiva material	Använd ej giftiga material	Använd ej tryckluft över 8 bar	Använd ej kran	Placeras ej instabilt
FI	Ei emäksisille aineille	Ei räjähtäville aineille	Ei vaarallisille aineille	Ei yli 8 baarin paineilmalle	Nosturin käyttö kielletty	Sijoitettava vakaasti paikalleen
DE	Keine ätzenden Substanzen verwenden.	Keine explosiven Materialien verwenden	Keine gefährlichen Materialien verwenden	Keinen Luftdruck über 8 Bar nutzen.	Keinen Kran verwenden.	Einheit stabil aufstellen.
DA	Der må ikke anvendes ætsende midler	Der må ikke anvendes sprængfarlige materialer	Der må ikke anvendes sundhedsfarlige materialer	Der må ikke anvendes trykluft over 8 bar	Der må ikke anvendes kran	Må ikke placeres ustabilt
NO	Forbudt å bruke etsende middel	Forbudt å bruke eksplosive materialer	Forbudt å bruke farlige materialer	Forbudt å bruke trykkluft over 8 bar	Forbudt å bruke kran	Forbudt å plassere ustabilt
NL	Geen bijtend materiaal gebruiken	Geen explosief materiaal gebruiken	Geen gevaarlijk materiaal gebruiken	Geen perslucht van meer dan 8 bar gebruiken	Geen kraan gebruiken	Niet onstabiel plaatsen
HU	Ne használjon maró anyagokat	Ne használjon robbanásveszélyes anyagokat	Ne használjon veszélyes anyagokat	Ne használjon 8 bar-nál nagyobb nyomású levegőt	Ne használjon darut	Ne helyezze ingatag felületre
PL	Nie używaj substancji żrących	Nie używaj materiałów wybuchowych	Nie używaj materiałów niebezpiecznych	Nie używaj ciśnienia sprężonego o wartości wyższej niż 8 bar	Nie używaj suwnicy	Nie ustawiaj w położeniu niestabilnym
ES	No utilizar cáusticas	No utilizar materiales explosivos	No utilizar materiales peligrosos	No utilizar aire comprimido de más de 8 bar	No utilizar grúa	No colocar en posición inestable
RO	Nu utilizați substanțe caustice	Nu utilizați materiale explozive	Nu utilizați materiale periculoase	Nu utilizați aer comprimat cu presiune de peste 8 bari	Nu utilizați macara	Nu așezați în poziție instabilă
IT	Non utilizzare materiali caustici	Non utilizzare materiali esplosivi	Non utilizzare materiali pericolosi	Pressione max dell'aria compressa: 8 bar	Non utilizzare una gru	Non collocare in luoghi instabili
FR	Ne pas utiliser de matériaux caustiques	Ne pas utiliser de matériaux explosifs	Ne pas utiliser de matériaux dangereux	Ne pas utiliser d'air comprimé supérieur à 8 bars	Ne pas utiliser de grue	Ne pas placer de manière instable
CS	Nepoužívejte žraviny	Nepoužívejte výbušné materiály	Nepoužívejte nebezpečné materiály	Nepoužívejte stlačený vzduch o tlaku nad 8 barů	Nepoužívejte jeřáb	Nepokládejte nestabilně
RU	Не используйте едкие вещества	Не используйте взрывоопасные материалы	Не используйте опасные материалы	Не используйте сжатый воздух давлением выше 8 бар	Не используйте кран	Не размещайте в неустойчивом положении



Safety

Study this manual carefully before using the vacuum cleaner for the first time.

Only authorized personnel are allowed to carry out electrical installation.

Get appropriate medical care immediately if in case of a personal injury.

Only connect a vacuum cleaner with a 1-phase motor to an earthed power socket that has the same voltage as that listed on the vacuum cleaner's nameplate.

Do not use the vacuum cleaner to collect material that is hot, explosive, highly flammable, chemically unstable, spontaneously ignitable, or which can release sparks. The vacuum cleaner must be ATEX approved for the appropriate zone if it is located near this type of material.

Always disable the control system before disconnecting power to the vacuum cleaner.

Completely disconnect the vacuum cleaner from all power sources before any type of service or transportation.

Replace all damaged components with original spare parts.

Do not remove the cover of the vacuum cleaner once it is started.

Do not put the vacuum hose inlet near a person's head.

Wear an approved breathing mask, and be careful not to spread dust when changing filters. Empty the dust into a container or plastic bag.

Do not use the vacuum cleaner if there is restricted or no airflow. The fan motor can become overheated.

Turn off the vacuum cleaner if liquid or foam escapes from it.

Store the vacuum cleaner in standing position.

Operating instructions

Generally, all the vacuum cleaners are delivered for use with dry material. For use with wet material, vacuum cleaners are delivered with a filter basket and float ball. For more information, please contact the distributor or manufacturer.

Bulk-bags

Certain Ex products should be equipped with conductive bulk-bags for collecting material. Other collection methods may be used if the system risk analysis finds them to be safe.

Vacuum cleaner use, dry material:

1. Connect power supply.
2. Turn on switch to start the vacuum cleaner.
3. When the filter is clogged, the suction power is reduced.
4. Switch off the vacuum cleaner before filter cleaning and emptying the container.
 - a. Clean the cartridge filter by tapping it slightly on the floor.
 - b. Shake or wash the filter bag.
 - c. Replace the dust bag.

NOTE! Ab/Bb 216, 221, and 426 have an outside cleaning handle. See the filter cleaning section.

Vacuum cleaner use, wet material:

1. Connect power supply.
2. Turn on switch to start the vacuum cleaner.
3. When the container is full, the suction flow is shut off by the float ball.
4. Switch off the vacuum cleaner before emptying the container.

Vacuum cleaner use, NCF filter:

1. Connect power supply.
2. Turn on switch to start the vacuum cleaner.
3. When the filter is clogged, the suction power is reduced.
4. Switch off the vacuum cleaner before emptying or cleaning the filter.
5. Connect the compressed air line to the compressed air feeding hose to start filter cleaning.
 - a. Repeated filter cleaning is done by a new connection for 15 seconds.
6. Disconnect the compressed air when done.

Vacuum cleaner use, pre-separator:

1. Connect power supply.
2. Turn on switch to start the vacuum cleaner.
3. When the filter is clogged or the pre-separator is full, the suction power is reduced.
4. Switch off the vacuum cleaner before emptying the pre-separator or cleaning the filter.
5. Clean the filter as described in *Vacuum cleaner use, NCF filter*.

Service



WARNING! Risk of personal injury.

Completely disconnect the vacuum cleaner from all power sources before any type of service.

External control, unit off:

- Control and replace cables and plugs if damaged.
- Replace leaking suction hoses and couplings

Internal control, unit off:

- Check regularly that the rubber pad on the wear plate in the silo is not damaged or frayed.

Internal control, unit on:

- Replace worn out and leaking gaskets.
- Repair or replace worn out filters to avoid wear and tear of the turbine rotor or blow through of dust.
- Replace torn or full dust bag.
- Repair or replace reusable dust bag. Clean the dust bag if it becomes dirty.

Control with top cover attached, unit on:

- Start the motors in sequence using the main switch. If the main switch does not function properly or is damaged, replace it.
- If specified vacuum is not reached, check all gaskets and connections. Execute the vacuum test with suction inlet(s) closed.
- If the noise level is higher than the maximum specified, dismantle the silencer hood and check the silencing material. Replace it if it is damaged.

Control with top cover removed, unit on:

- Start the vacuum with the top cover removed.
- Control that the motors are running clockwise as seen from above.



WARNING! Risk of Personal injury.

Do not touch the motor with any tool during this operation.

- Control the thermal function by clogging the cooling air inlets with sheets of paper. The vacuum should soon stop without getting overheated (about 75°C/167 °F).

Control with top and secondary covers removed, unit off:

- Control that all cable connections are properly secured and screws tightened.
- Control that the carbon brushes are not worn out. Replace them if necessary.
- Control wear of commutator. Replace motor if commutator is grooved.
- Turn motor. If there is resistance in the bearings or turbo fan, replace the motor.
- If any wiring in the circuit board is burned, replace the card.

Trouble Shooting

Problem	Fault	Solution
Motor will not start	Electrical supply not connected	Connect the electrical supply.
	Thermoswitch not reset or defect (T-mod)	Dismantle top cover and clean or exchange cooling air filter. Reset the thermoswitch. If the thermoswitch is defect, please contact the distributor.
	Switch supply or cable defect	Contact the distributor
	Radio interference suppression defect	Contact the distributor
None or bad suction capacity	Switch not completely turned on	Turn switch on
	One or two motors defect	Dismantle top cover, control the brushes and commutators. If the brushes are worn out, please replace. If the commutators are burnt, contact the distributor.
	Clogged suction hose or inlet	Disconnect suction hose. Turn and suck in the opposite direction. If still clogged, open it with a rod.
	Clogged filter	For filter bag and cartridge filter cleaning; please see operation instruction. NCF filter cleaning; check filter cleaning function by listening to noise from blow-out valve. If not in operation, check quick coupling and function of blow-out valve.
	Leaking suction hose	Tape or replace suction hose.
	Leaking gaskets	Damage on neoprene gasket; remove and replace. Use suitable two-component glue.
	Discharge valve open.	Close valve
Dust in exhaust air	Filter wrongly or not installed	Check the filter and change if necessary.
	Filter defect	Change filter.
Water in exhaust air	Filter basket or float ball wrongly or not installed	Reattach filter basket or float ball. Please see operation instruction.
	Filter basket or float ball defect	Change.
Abnormal noise level	Leaking gaskets	Damage on neoprene gasket; remove and replace. Use suitable two-component glue.
	Sound absorbing material defect	Dismantle the silencer hood and remove dirt. Replace damaged silencing material.

CUSTOMER: _____

VACUUMER TYPE/MODEL: _____

SERVICE DATE _____ SERVICED BY: _____

		OK	Repaired	Replaced	Replaced part number
1.0	CONTROL WITHOUT RUNNING, OUTSIDE				
1.1	Silencer				
1.2	Compressed air hose				
1.3	Container(s)				
1.4	Trolley				
1.5	Suction hose(s)				
1.6	Preseparator/cyclone				
1.7	Accessories				
1.8	Other items, specify				
2.0	CONTROL WITHOUT RUNNING, INSIDE				
2.1	Gasket(s)				
2.2	Lid, vacuum head				
2.3	Container(s)				
2.4	Filter(s)				
2.5	Dustbag				
2.6	Float ball				
2.7	Other items, specify				
3.0	CONTROL RUNNING, (TOP COVER INSTALLED)				
3.1	Start/stop switch function				
3.2	Vacuum				
3.3.	Noise level				
4.0	CONTROL RUNNING, (TOP COVER DISMANTLED)				
4.1	Rotation motors				
4.2	Thermoswitch function				
5.0	CONTROL WITHOUT RUNNING, (TOP AND SECONDARY COVERS DISMANTLED)				
5.1	Electric cable connections				
5.2	Carbon brushes				
5.3	Commutator wear				
5.4	Motor wear				
5.5	Radio disturbance compression card				

		OK	Repaired	Replaced	Replaced part number
6.0	OTHER ITEMS (SPECIFY)				
6.1					
6.2					
6.3					
6.4					
6.5					
6.6					
6.7					
6.8					
6.9					



WARNING! Risk of Personal injury

Disconnect the vacuum cleaner before doing any service.

- 1.2 Control the cable and plug, and replace it if damaged.
- 1.5 Replace leaking suction hoses and couplings.
- 2.1 Replace worn out, aged and leaking gaskets.
- 2.4 Repair or replace worn out filters to avoid wear and tear of the turbine rotor, or blow through of health hazardous materials.
- 2.5 Replace torn or full antistatic dust bag.
Repair or replace reusable dust bag. If it is clogged, wash or shake it clean.
- 2.6 Clean the water level limiting device regularly and examine it for signs of damage.
- 3.1 Start the motors in sequence using the main switch.
If the main switch does not function properly or is damaged, replace it.
- 3.2 If specified vacuum is not reached, check all gaskets and connections.
Execute the vacuum test with suction inlet(s) closed.
- 3.3 If the noise level is higher than the maximum specified, dismantle the silencer hood and check the silencing material.
Replace it if damaged.
- 4.1 Start the vacuum with the top cover removed.
Control that the motors are running clockwise as seen from above.



WARNING! Risk of Personal injury

Do not touch the motor directly or with any tool during this operation.

- 4.2 Control the thermal function by clogging the cooling air inlets with sheets of paper. The vacuum should soon stop without getting overheated (about 75°C/167 °F).
- 5.1 Control that all cable connections are properly secured and screws tightened.
- 5.2 Control that the carbon brushes are not worn out. Replace them if necessary.
Replace after about 900 hours. Replaced brushes must be checked after 500 hours.
- 5.3 Control wear of commutator. Replace motor if commutator is grooved.
- 5.4 Turn motor. If there is resistance in bearings or turbo fan, replace the motor.
- 5.5 If any wiring in the printing card is burned, replace the card.

Model specification

Description: Ab115 - NE32, S50 wo/accessories

Model: 42111581

Code no.	Description	Qty.
43022001	NE32, S50	1
43110100	Filter bag S50 polyester/teflon	1
43322001	Container S50 inlet d51	1
43670001	Fastener complete	1
43660001	Basket S50 f/ball/filter bag	1
43660300	Float ball S50/200 d153, 480g antistatic	1
43662001	Accessory basket S50	1
43722001	Trolley S50 tippable	1

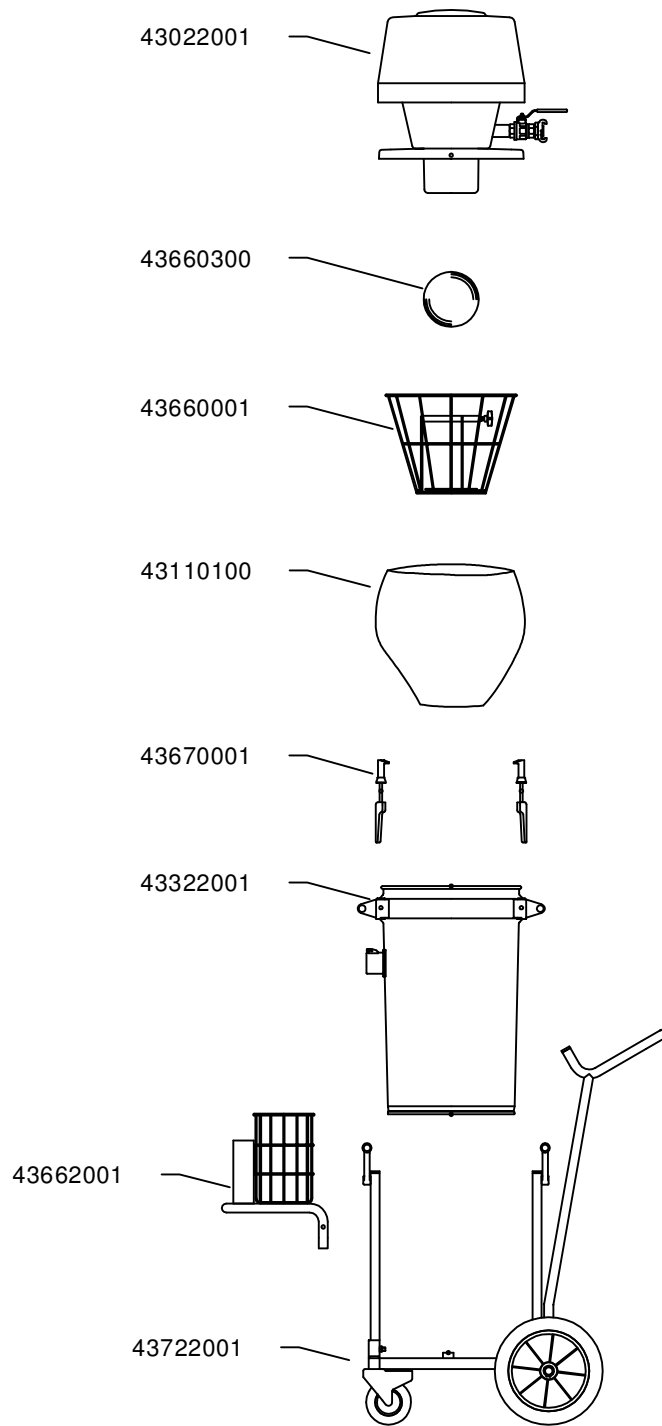



MAX 8 bar



S235JR(St37.2)

- 43904001
- 43904101
- 43904201

- 43904002
- 43904102
- 43904202

43903010

43909001

43909008

System 50

- 43610001
- 43610011 A4
-

System 200

- 43615001
- 43615011 A4
-

- 43621001
- 43621200 A4
-

- 43937006
- 43937007



43905020



43937010

System 50

- 43901052
- 43901050

System 200

- 43901053
- 43901051

43908003

Vacuum producer	Compressed air consumption Nm ³ /min	Max. vacuum mmWC	Max. vacuum -kPa	Max. air flow Nm ³ /hr	Noise level* dB(A)	Ejector body	
<input type="checkbox"/>	NE22	1,0	2100	21	306	72,0	43905001
<input checked="" type="checkbox"/>	NE32	1,6	3100	31	342	74,0	43905002
<input type="checkbox"/>	NE42	2,2	4200	42	360	73,5	43905003
<input type="checkbox"/>	NE52	3,0	5200	52	342	75,5	43905004
<input type="checkbox"/>	NE56	2,7	2500	25	564	73,5	43905005
<input type="checkbox"/>	NE64	4,3	6800	68	330	77,0	43905006
<input type="checkbox"/>	NE66	4,1	3800	38	630	76,5	43905007
<input type="checkbox"/>	NE74	5,3	7800	78	318	75,0	43905008
<input type="checkbox"/>	NE76	5,4	4800	48	690	78,0	43905009
<input type="checkbox"/>	NE96	8,6	6800	68	660	78,0	43905011
<input type="checkbox"/>	NE56x2	5,4	2500	25	1128	76,5	43905005
<input type="checkbox"/>	NE96x2	17,2	6800	68	1320	79,0	43905011

*Noise level - distance: 3 m - height: 1,1 m

(Air pressure 7 bar)

0 (Off)

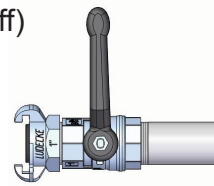

1 (On)

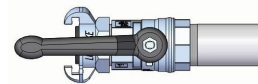

- 43885001
- 43612001

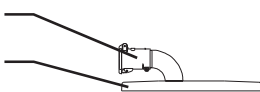

- 43616100 d63
- 43616200 d76



- 43901021 d63
- 43901022 d76

- 43885001
- 43616007
-

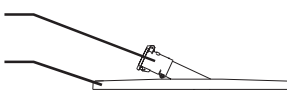

- 43615020
- 43615031

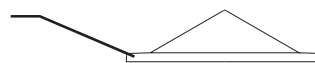

43 0 22 001



MAX 8 bar



S235JR(St37.2)

43214001

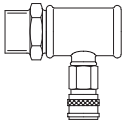

43214100

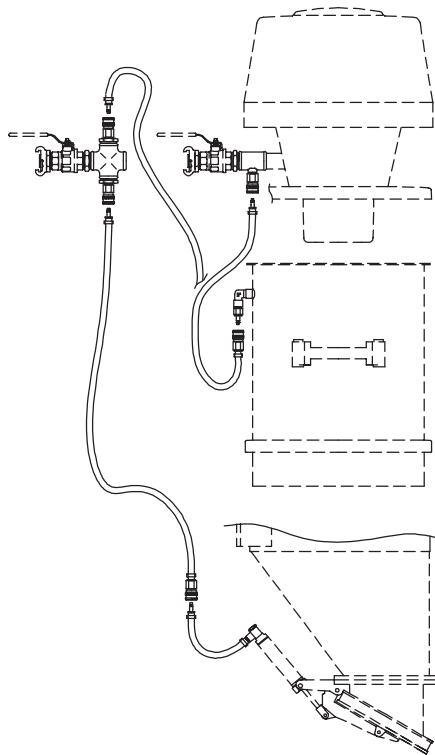
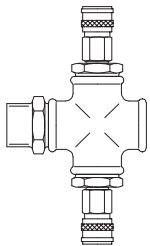

Y

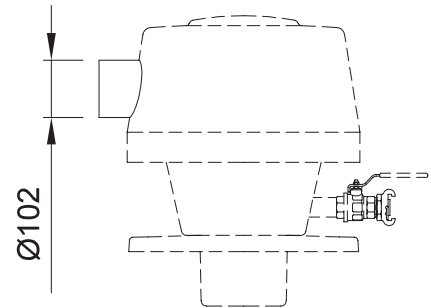

Z

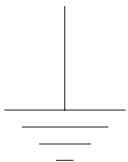

Ex

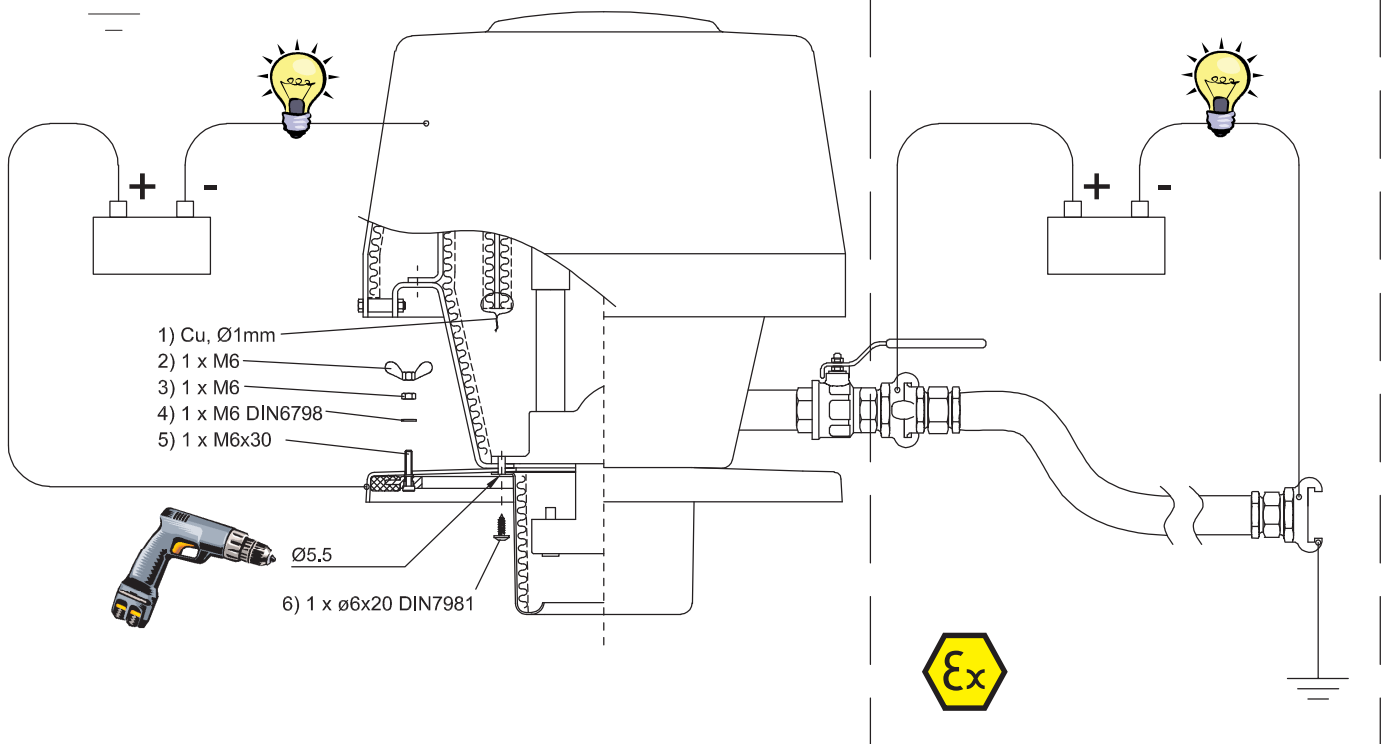

43 0 22 001



1

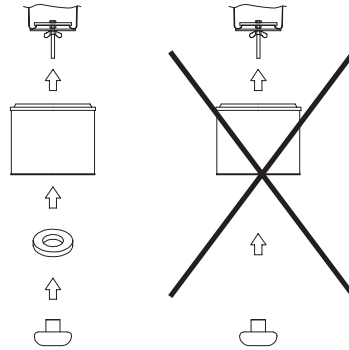
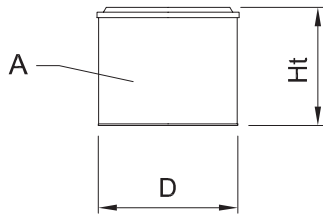

2

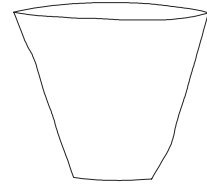

3

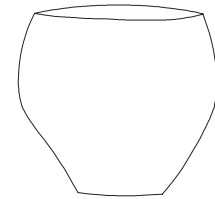

	Product number:	Area m ²	Max. temp. °C	Diameter mm	Height mm	Weight kg	BIA	EN 60335-2-69 / EN1822	Anti-static	Wash-able	End plate*
<input type="checkbox"/>	43110001	0,50	70	-	-	0,6	-	-	-	-	-
<input checked="" type="checkbox"/>	43110100	0,35	120	-	-	0,2	-	-	-	-	-
<input type="checkbox"/>	43110200	0,35	120	-	-	0,2	-	-	X	-	-
<input type="checkbox"/>	43110300	0,59	120	-	-	0,4	-	-	-	-	-
<input type="checkbox"/>	43110400	0,59	120	-	-	0,4	-	-	X	-	-
<input type="checkbox"/>	43120100	2,38	70	264	220	1,7	U,S,G,C	M	-	-	-
<input type="checkbox"/>	43130001	2,38	70	264	220	2,0	U,S,G,C	M	-	-	-
<input type="checkbox"/>	43130100	2,38	70	264	220	1,0	U,S,G,C	M	-	-	-
<input type="checkbox"/>	43130200	5,40	70	264	470	2,0	U,S,G,C	M	-	-	-
<input type="checkbox"/>	43130201	5,40	70	264	470	3,0	U,S,G,C	M	-	-	-
<input type="checkbox"/>	43130300	6,90	70	264	600	3,0	U,S,G,C	M	-	-	-
<input type="checkbox"/>	43130301	6,90	70	264	600	4,0	U,S,G,C	M	-	-	-
<input type="checkbox"/>	43130400	10,00	70	264	870	5,0	U,S,G,C	M	-	-	-
<input type="checkbox"/>	43130401	10,00	70	264	870	5,0	U,S,G,C	M	-	-	-
<input type="checkbox"/>	43130500	1,56	70	264	220	2,1	K1/K2	H13	-	-	-
<input type="checkbox"/>	43120200	1,56	70	264	220	2,0	K1/K2	H13	-	-	-
<input type="checkbox"/>	43130700	3,50	70	264	470	3,2	K1/K2	H13	-	-	-
<input type="checkbox"/>	43130702	3,50	70	264	470	4,0	K1/K2	H13	-	-	-
<input type="checkbox"/>	43130800	4,50	70	264	600	3,8	K1/K2	H13	-	-	-
<input type="checkbox"/>	43130801	4,50	70	264	600	3,0	K1/K2	H13	-	-	-
<input type="checkbox"/>	43130900	6,50	70	264	870	4,8	K1/K2	H13	-	-	-
<input type="checkbox"/>	43130901	6,50	70	264	870	6,0	K1/K2	H13	-	-	-
<input type="checkbox"/>	43120300	2,28	120	264	220	2,0	U,S,G,C	M	-	X	-
<input type="checkbox"/>	43120301	2,38	120	264	220	2,0	U,S,G,C	M	X	X	GS
<input type="checkbox"/>	43120303	10,00	120	264	87	4,0	U,S,G,C	M	X	X	-
<input type="checkbox"/>	43120304	2,38	120	264	220	2,0	U,S,G,C	M	X	X	A4
<input type="checkbox"/>	43120400	0,7	80	338	42	0,8	U,S,G,C	M	-	-	-
<input type="checkbox"/>											
<input type="checkbox"/>											

* A2=AISI 304 / A4=AISI 316L / GS=Galvanized steel

43 1 10 100



S 235JR (St37.2)

- 43999021
- 43999721 A4

- 43999031
- 43999531

- 43999003
- 43885001

- 43909003
- 43909103 A4
-

- 43907013
- 43907015

- 43907004
- 43907104



S235JR(St37.2)

System 50 & 200

43908004



43903041

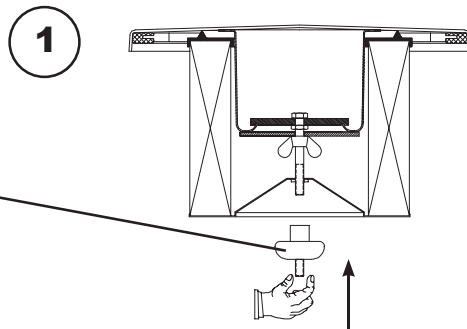

43908014

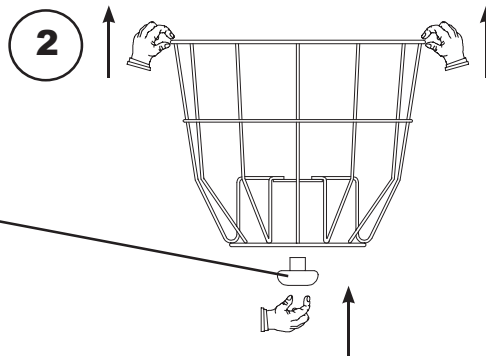

43908010

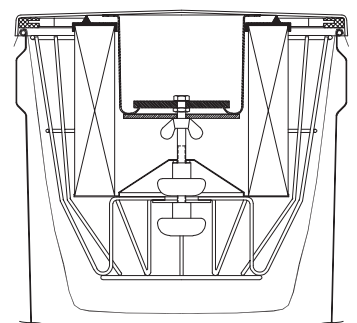
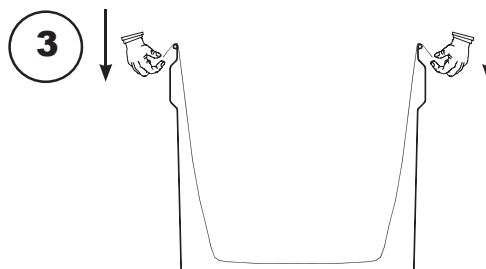

43 6 60 001

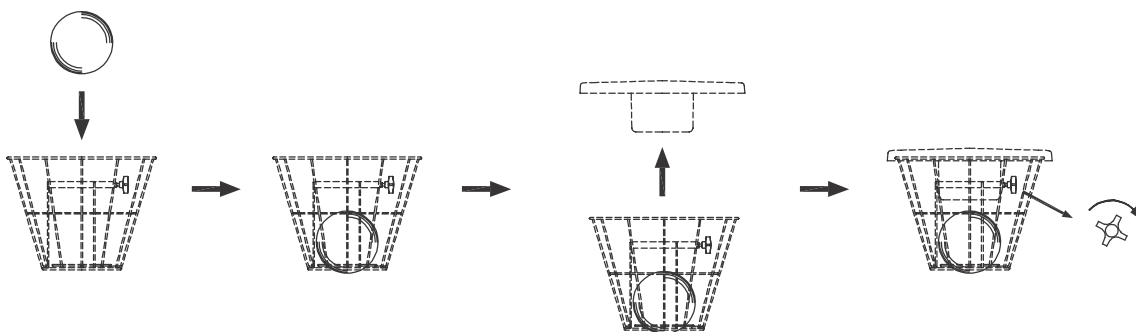

januar	februar	mars
1 31 1 2 3 4 5 6 2 7 8 9 10 11 12 13 3 14 15 16 17 18 19 20 4 21 22 23 24 25 26 27 28 29 30	1 2 3 4 5 6 7 8 9 10 11 12 13 14 15 16 17 18 19 20 21 22 23 24 25 26 27	1 2 3 4 5 6 7 8 9 10 11 12 13 14 15 16 17 18 19 20 21 22 23 24 25 26 27 28 29 30 31
april	mai	juni
1 2 3 4 5 6 7 8 9 10 11 12 13 14 15 16 17 18 19 20 21 22 23 24 25 26 27 28 29 30	1 2 3 4 5 6 7 8 9 10 11 12 13 14 15 16 17 18 19 20 21 22 23 24 25 26 27 28	1 2 3 4 5 6 7 8 9 10 11 12 13 14 15 16 17 18 19 20 21 22 23 24 25 26 27 28 29 30 31
juli	august	september
1 2 3 4 5 6 7 8 9 10 11 12 13 14 15 16 17 18 19 20 21 22 23 24 25 26 27 28 29 30 31	1 2 3 4 5 6 7 8 9 10 11 12 13 14 15 16 17 18 19 20 21 22 23 24 25 26 27 28	1 2 3 4 5 6 7 8 9 10 11 12 13 14 15 16 17 18 19 20 21 22 23 24 25 26 27 28 29 30
oktober	november	desember
1 2 3 4 5 6 7 8 9 10 11 12 13 14 15 16 17 18 19 20 21 22 23 24 25 26 27 28 29 30 31	1 2 3 4 5 6 7 8 9 10 11 12 13 14 15 16 17 18 19 20 21 22 23 24 25 26 27 28 29 30	1 2 3 4 5 6 7 8 9 10 11 12 13 14 15 16 17 18 19 20 21 22 23 24 25 26 27 28 29 30 31



EN	Mounting instructions	FI	Asennusohjeet	NO	Montasjeanvisning
CZ	Montážní návod	FR	Instruction de montage	PL	Instrukcja montażu
DE	Montageanleitung	HU	Szerelési utasítás	RO	Instrucțiuni de montare
DK	Monteringsvejledning	IT	Istruzioni di montaggio	RU	Инструкция по монтажу
ES	Instrucciones de montaje	NL	Montage-instructies	SE	Monteringsanvisning

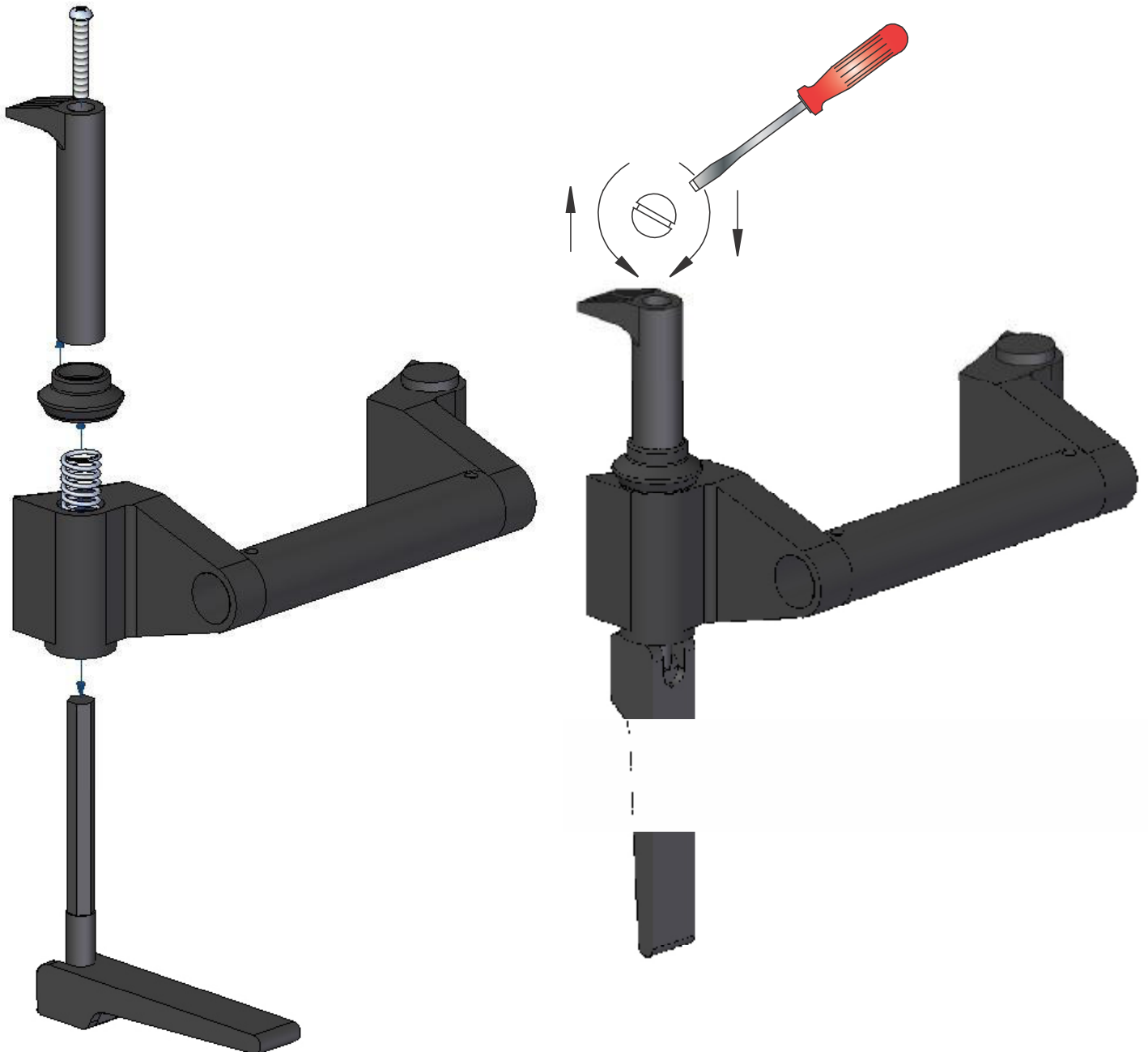

43 6 70 001



S235JR(St37.2)

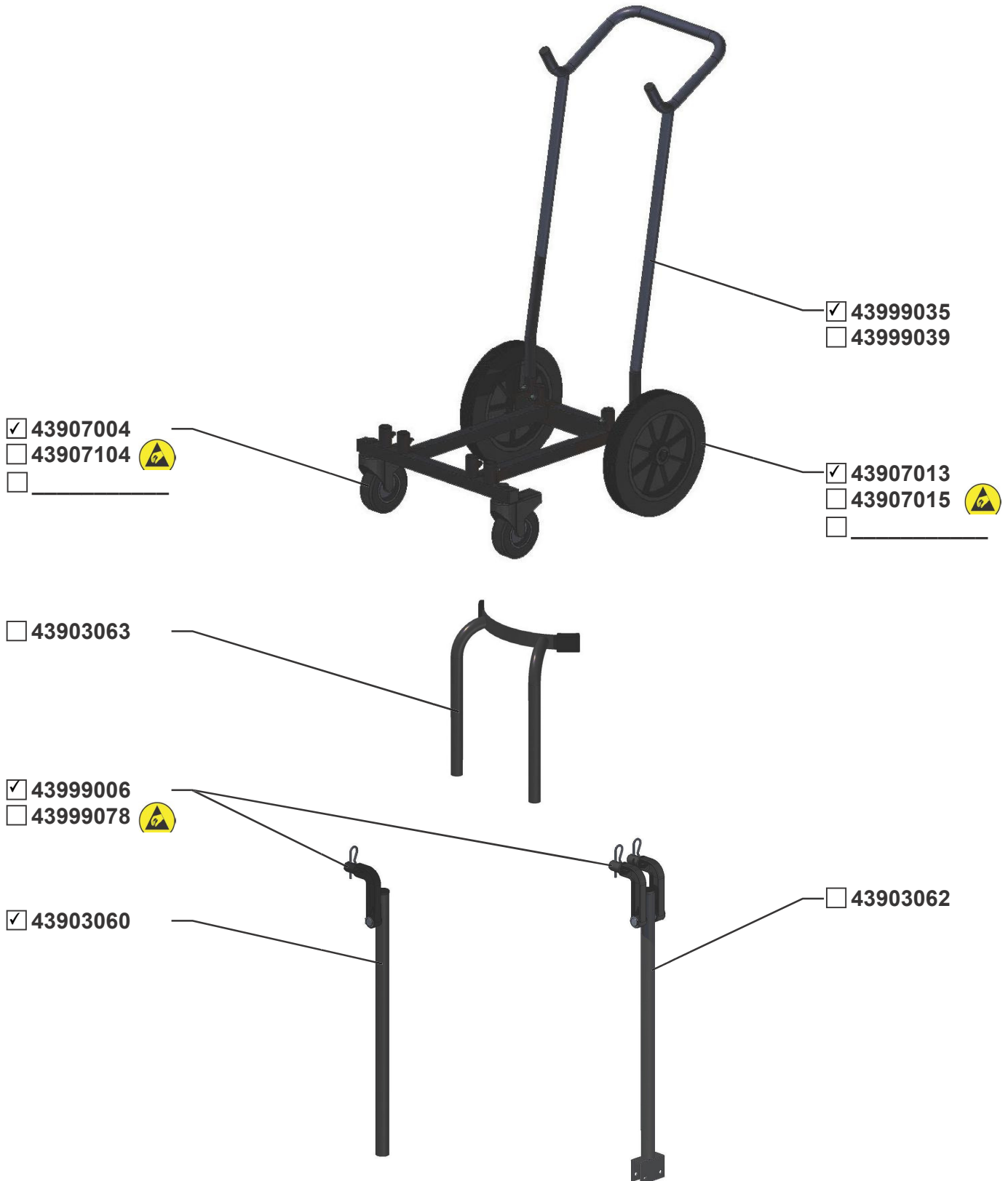

43 7 22 001

Addendum to Manual

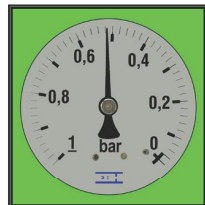
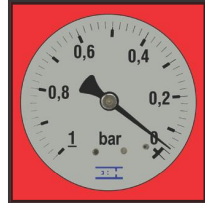

NE	-mmWC	-kPa	Nm ³ /hr
22	2100	21	306
32	3100	31	342
42	4200	42	360
52	5200	52	342
56	2500	25	564
64	6800	68	330
66	3800	38	630
74	7800	78	318
76	4800	48	690
96	6800	68	660
56x2	2500	25	1128
96x2	6800	68	1320

NE



6 - 8 bar OK!

